

UVB30DK

Universal 30" Telescopic Downdraft System

DIMENSIONS AND INSTALLATION INFORMATION (IN INCHES)

NOTE: Telescopic downdraft vents are not recommended to be installed with cooktops that are flush mounted.

Approved for use with the following Monogram, GE Profile™ Series and GE® Series cooktops—30" electric models, 30" gas sealed-burner models and 30" induction models.

NOT APPROVED FOR USE WITH STANDARD BURNER GAS COOKTOPS.

NOTE: The countertop must be at least 26" deep with a flat surface area of 23-1/2" or more, front to back. In addition, other clearances to the front edge of the countertop must be considered.

NOTE: Dimensions shown are for reference only. Before cutting out countertop, refer to instructions packed with downdraft and cooktop.

NOTE: Installation on cabinets/countertops against the wall will not be possible in most applications. Against the wall installations are limited to dimension requirements. Refer to installation instructions packed with product for further details.

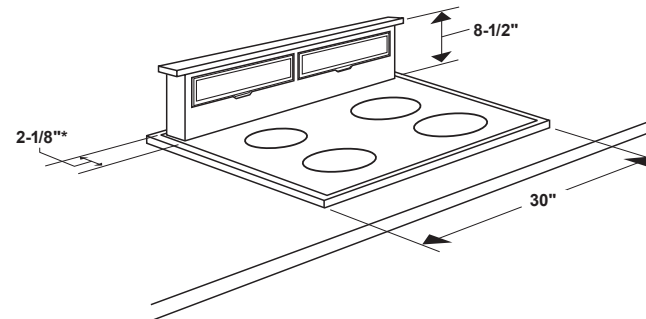
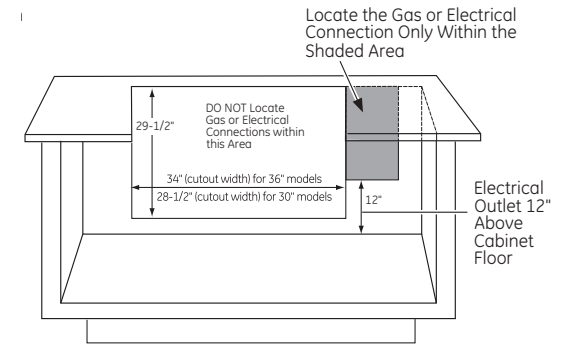
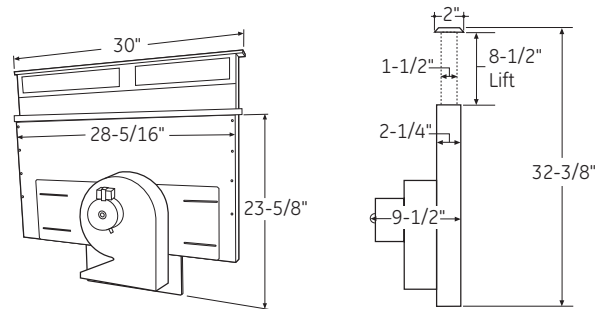

*Minimum distance required between the back edge of the cooktop and the back of the cutout in the countertop



For answers to your Monogram, GE Café™ Series, GE Profile™ or GE Appliances product questions, visit our website at geappliances.com or call GE Answer Center® Service, 800.626.2000.











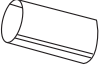



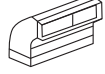

Specification Revised 9/20

UVB30DK

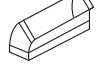
Universal 30" Telescopic Downdraft System

VENTING DUCT INFORMATION

DUCT PIECES	EQUIVALENT LENGTH*	DUCT PIECES	EQUIVALENT LENGTH*
 6" ROUND STRAIGHT	1 ft. (per foot length)	 3-1/4" X 10" TO 6" ROUND TRANSITION	2 ft.
 3-1/4" X 10" STRAIGHT	1 ft. (per foot length)	 6" ROUND TO 3-1/4 X 10" TRANSITION 90° ELBOW	4 ft.
 6" 90° ELBOW	12 ft.	 3-1/4" X 10" TO 6" ROUND TRANSITION 90° ELBOW	4 ft.
 6" 45° ELBOW	7 ft.	 6" ROUND WALL CAP WITH DAMPER	24 ft.
 3-1/4" X 10" 90° ELBOW	14 ft.	 3-1/4" X 10" WALL CAP WITH DAMPER	24 ft.
 3-1/4" X 10" 45° ELBOW	12 ft.	 6" ROUND ROOF CAP	33 ft.
 3-1/4" X 10" 45° ELBOW	33 ft.	SHOULD NOT EXCEED 100 EQUIVALENT FT. *Equivalent length of duct pieces is based on actual test conducted by GE Evaluation Engineering and reflects requirements for good venting performance.	
 6" ROUND TO 3-1/4 X 10" TRANSITION	2 ft.		

PLAN THE DUCTWORK

1. This downdraft blower system is designed for use with 3-1/4" x 10" ductwork (can be transitioned to 6" round). Two different discharge directions are available with side-to-side adjustment for the accurate alignment of ductwork.
2. For best performance: choose the ducting option which allows the shortest length of ductwork and a minimum number of elbows and transitions. Check location of floor joists, wall joists, wall studs, electrical wiring or plumbing for possible interference.

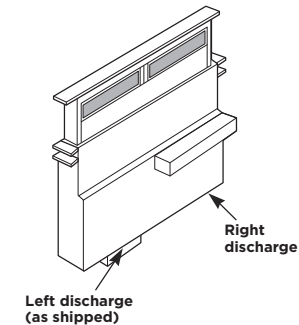

STEPS TO DETERMINE FLEXIBLE DUCTING'S EQUIVALENT LENGTH

1. Measure the actual amount of offset (Maximum 3" recommended). The effect upon airflow is dependent upon the amount of offset.
2. Calculate the equivalent ducting allowances using:
 $(\text{__in. offset}) \times (14 \text{ ft. per inch}) = \text{__ft. equivalent length.}$
3. Total equivalent length of ducting should not exceed the maximum recommendation of 100 feet for optimal venting performance.



For answers to your Monogram, GE Café™ Series, GE Profile™ or GE Appliances product questions, visit our website at geappliances.com or call GE Answer Center® Service, 800.626.2000.

UVB30DK

Universal 30" Telescopic Downdraft System

FEATURES AND BENEFITS

370-CFM venting system – Effectively removes smoke, grease, odor and moisture

Four-speed fan control – Helps draw smoke, grease, odors and moisture out of the kitchen air

Telescopic hood – Raises over cooktop surface and retracts when not in use

Separate remote raise/lower switch

Model UVB30DKBB – Black on Black

