

ZONELINE®

Packaged Terminal Air Conditioners Product & Accessories Guide



good things, for life.



GE APPLIANCES

GE ZONELINE®

Designed, engineered and assembled in the U.S., GE Zoneline Packaged Terminal Air Conditioning units are built to last.

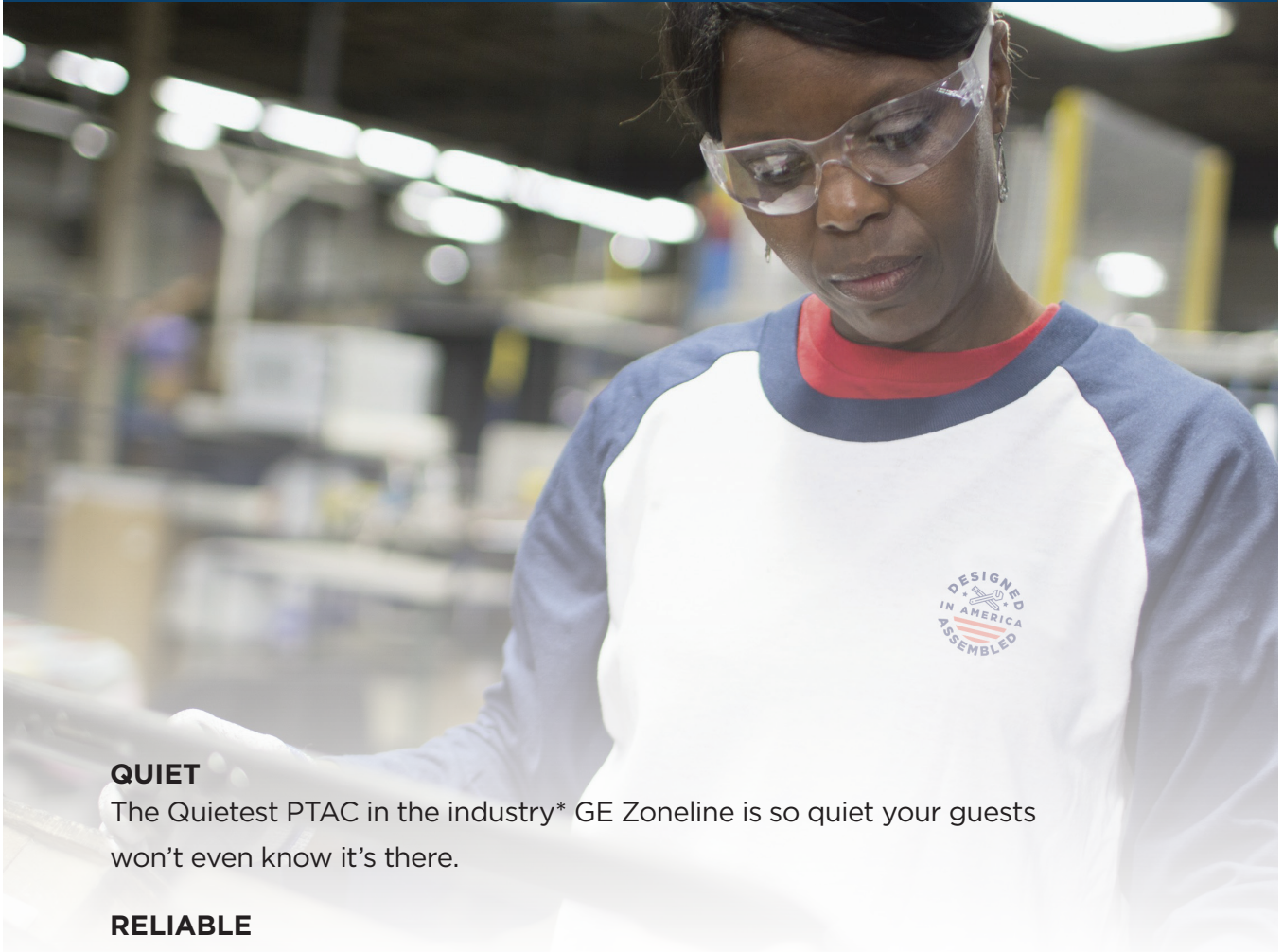

QUIET

The Quietest PTAC in the industry* GE Zoneline is so quiet your guests won't even know it's there.

RELIABLE

With over one million units installed across the U.S. and remarkably low service issues, GE Zoneline PTACs offer unrivaled reliability, consistent performance and constant guest comfort.

UNMATCHED SERVICE & SUPPORT

GE Appliances is the only manufacturer with a dedicated factory service network and field team. Our technicians service your Zoneline—and any other GE appliances you have—in no time, so guest comfort is not compromised.

* When compared to leading competitors. 12,000 BTUh heat pump models tested by independent third-party testing at a national acoustical lab, conducted March 2015 and October 2015, in accordance with ASTM and AHRI standards. The higher the STC rating, the better the unit blocks outside noise.

QUIETEST PTAC IN THE INDUSTRY*

With over one million Zonelines® installed across the U.S., the industry's quietest PTAC* offers unsurpassed reliability, consistent performance and continuous room comfort.



Randomized test of 7,000, 9,000, 12,000 and 15,000 BTUh models against equivalent leading competitor unit, September 2015 installed in hotel property.



Weather Barrier System Seal Is a seal around the edge of the unit blocking out dirt and outdoor noise.

BEST STC

against leading competitors.
(Sound Transmission Class)
Standard on all units. **Higher is better.**

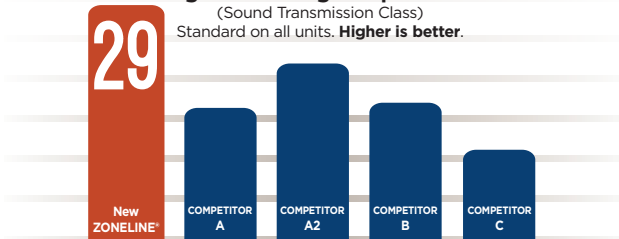

Independent third party testing at nationally accredited certified acoustic lab, conducted March 2015 and October 2015 in accordance with ASTM and AHRI standards.

BEST OITC

against leading competitors.
(Outdoor Indoor Transmission Class)
Standard on all units. **Higher is better.**



ROOM NOISE & TEMPERATURE MAKE A BIG DIFFERENCE

66%
of dissatisfied guests

are unlikely to return due to poor noise and temp control.**

33%
of dissatisfied guests

are unlikely to recommend the hotel for those reasons.**

**Clarabridge Ratings and Reviews, for hospitality data collected July 2013-June 2014.

MORE POWER. Less Noise.

GE® Zoneline® has the largest fan vs. leading competitor designs, which means less rotation and quieter performance.



EXPERT BRAINPOWER AT WORK.

The GE® Appliances team includes sound acoustics and mechanical engineers, with both a Master's Degree in sound transmission and a Ph.D. in Acoustics. These experts helped develop the design within our own state-of-the-art PTAC sound lab.



* When compared to leading competitors, 12,000 BTUh heat pump models tested by independent third-party testing at a national acoustical lab, conducted March 2015 and October 2015, in accordance with ASTM and AHRI standards. The higher the STC rating, the better the unit blocks outside noise.

VISIT ZONELINE.COM OR CALL 888.231.2548

ZONELINE® QUIET FEATURES AVAILABLE ON ALL MODELS

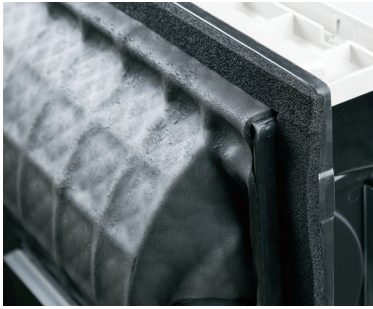

BAKED-ON MASTIC SOUND BARRIER

A heavy-duty barrier covers the back of the unit for superior sound insulation.

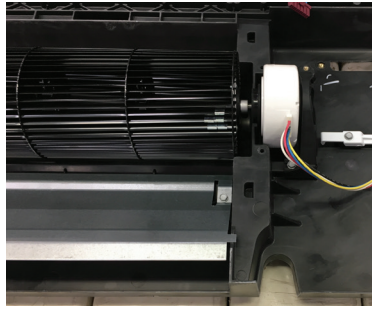

BLOWER & DC MOTORS

A large cross-flow blower and two DC fan motors keep the unit quiet for customers & guests while providing smart fan cooling & heating performance.

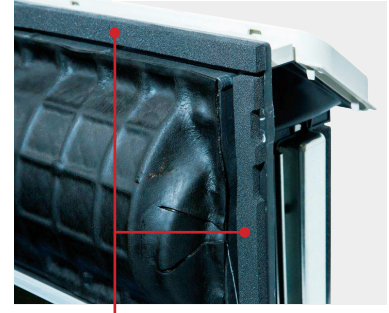

WEATHER BARRIER SYSTEM SEAL

A seal around the perimeter of the units keeps noise and dirt outside.

ZONELINE® STANDARD FEATURES AVAILABLE ON ALL MODELS



SYSTEM COMPATIBILITY

Compatible with a wide variety of thermostats and energy management systems, including central desk control.



EFFICIENT HEAT PUMP

Exclusive Reverse Cycle Defrost increases efficiency and allows unit to run in heat pump mode longer. Backup resistance heat provides comfort during severe cold temperatures. Available on all heat pump models.



ELECTRONIC TOUCH CONTROLS

Easy-to-use controls with clear LED readout provide a user-friendly experience.

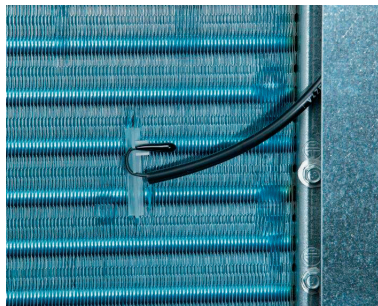

HEAT & FREEZE SENTINEL

Keeps room from overheating or freezing while meeting guest comfort and protecting against damage.



BASE PAN

Made of sheet-molding compound (SMC) & durable resin, the base pan resists rust.



ELECTRONIC TEMPERATURE LIMITING

Prevents expensive overcooling and overheating of rooms. Limits are factory set for savings, but can be adjusted to meet specific needs.



PREMIUM GUARD SEACOAST PROTECTION*

Special coatings, paintings and stainless steel components ensure lasting performance in challenging environments such as oceanfront properties.



MAKEUP AIR*

A secondary system provides continuous outdoor air. The supplemental dehumidification system operates when outdoor temperatures are above 50 degrees F and when relative humidity levels rise above 55%. Available on select models.



DRY AIR 25*

Zoneline Dry Air models remove 20%-35% more moisture from the air than standard Zoneline air conditioners,** making them perfect for high humidity climates.

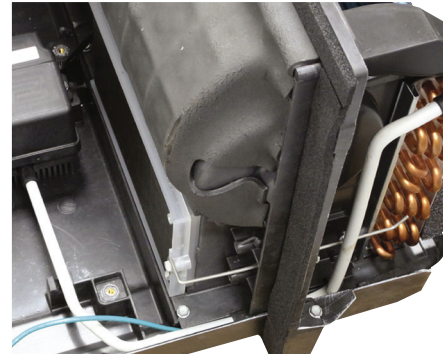

INTERNAL CONDENSATE REMOVAL (ICR)*

A system that minimizes the amount of condensate draining from the unit when in heat pump mode.

*Available on select models.

**Varies when comparing dehumidification rates of the 7,000/9,000/12,000 BTU base models to Dry Air model counterparts. AZ45 Series electric resistance models only.

ZONELINE® PACKAGED TERMINAL AIR CONDITIONERS

AZ45 SERIES | COOLING AND ELECTRIC HEAT

- Digital LED display
- Variable fresh air vent control
- Cross-flow blower
- Two DC fan motors
- Smart fan cooling
- Heat and Freeze Sentinel
- Remote thermostat capability
- Electronic temperature limiting
- Works with central desk control and through wall fans

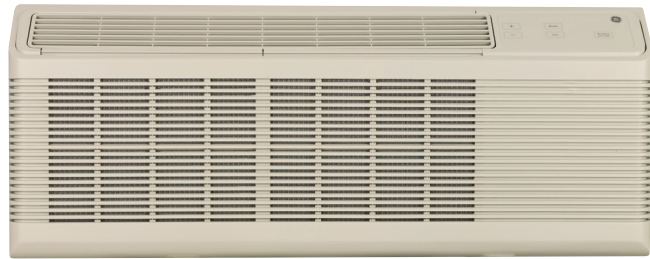
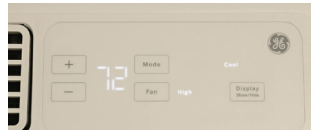

AZ45 SERIES 230V/208V

BASE

	BTU	EER	Volts
AZ45E07DAB	7,200/7,000	13.4/13.4	230/208
AZ45E09DAB	9,700/9,600	12.1/12.1	230/208
AZ45E12DAB	11,600/11,500	11.7/11.8	230/208
AZ45E15DAB	14,200/14,100	10.5/10.5	230/208

PREMIUM GUARD SEACOAST PROTECTION

	BTU	EER	Volts
AZ45E07DAC	7,200/7,000	13.4/13.4	230/208
AZ45E09DAC	9,400/9,300	11.8/11.8	230/208
AZ45E12DAC	11,600/11,500	11.7/11.8	230/208
AZ45E15DAC	14,000/13,900	10.3/10.4	230/208

DRY AIR 25

	BTU	EER	Volts
AZ45E07DAP	6,900/6,800	12.8/12.8	230/208
AZ45E09DAP	9,400/9,300	12.1/12.1	230/208
AZ45E12DAP	11,200/11,100	11.4/11.5	230/208

AZ45 GE ZONELINE® WITH MAKEUP AIR

Includes all AZ45 features plus:

- Delivers 25-50 CFM of continuous, Makeup Air
- Dehumidifies incoming air when outdoor relative humidity is above 55% and outdoor temperatures are above 50 degrees F
- Motorized vent door
- May reduce the need for rooftop units

AZ65 SERIES | HEAT PUMP WITH MAKEUP AIR

Includes all resistant heat Makeup Air features, plus:

- Staged heating
- Heat pump with back up resistance heat option
- Reverse cycle defrost

MAKEUP AIR

	Cooling BTU	Heating BTU	EER	COP*	Volts
AZ65H07DBM	7,000/7,000	6,200/6,100	12.5/12.5	4.0/4.0	230/208
AZ65H09DBM	9,200/9,100	8,000/7,900	11.3/11.3	3.3/3.3	230/208
AZ65H12DBM	11,500/11,400	10,200/10,000	11.2/11.2	3.5/3.5	230/208
AZ65H15DBM	14,000/13,800	13,200/13,000	10.1/10.1	3.2/3.2	230/208

MAKEUP AIR

	Cooling BTU	Heating BTU	EER	COP*	Volts
AZ65H07EBM	6900	6000	12.5	3.9	265
AZ65H09EBM	9,200	8,100	11.5	3.6	265
AZ65H12EBM	11,600	10,000	11.3	3.4	265

NOTE: Because Makeup Air increases room BTU load requirements and requires additional PTAC cooling or heating, the building's electrical needs may be impacted.

NOTE: Makeup Air models listed above are not recommended for installation within two miles of coastal areas.

NOTE: It is strongly recommended to install Makeup Air with wall thermostats.

Specifications subject to change.

ZONELINE® PACKAGED TERMINAL AIR CONDITIONERS

AZ65 SERIES | HEAT PUMP

Includes all resistant heat features, plus:

- Staged heating
- Heat pump with back up resistance heat option
- Reverse cycle defrost

AZ65 SERIES 230V/208V

BASE

	Cooling BTU	Heating BTU	EER	COP*	Volts
AZ65H07DAB	7,100/6,900	6,200/6,100	13.0/13.0	4.0/4.0	230/208
AZ65H09DAB	9,700/9,600	8,100/8,000	12.2/12.2	3.7/3.7	230/208
AZ65H12DAB	11,900/11,800	10,400/10,300	11.6/11.8	3.6/3.6	230/208
AZ65H15DAB	14,400/14,200	13,500/13,300	10.5/10.5	3.2/3.2	230/208

PREMIUM GUARD SEACOAST PROTECTION

	Cooling BTU	Heating BTU	EER	COP*	Volts
AZ65H07DAC	7,100/7,000	6,200/6,100	13.0/13.0	4.0/4.0	230/208
AZ65H09DAC	9,600/9,500	8,100/8,000	12.2/12.2	3.7/3.7	230/208
AZ65H12DAC	11,800/11,600	10,300/10,200	11.8/11.8	3.6/3.6	230/208
AZ65H15DAC	14,400/14,200	13,200/13,000	10.4/10.4	3.2/3.2	230/208

INTERNAL CONDENSATE REMOVAL

	Cooling BTU	Heating BTU	EER	COP*	Volts
AZ65H07DAD	7,000/6,900	6,200/6,000	13.0/13.0	4.0/4.0	230/208
AZ65H09DAD	9,600/9,500	8,200/8,000	12.0/12.0	3.6/3.6	230/208
AZ65H12DAD	11,800/11,600	10,400/10,200	11.5/11.5	3.5/3.5	230/208
AZ65H15DAD	14,100/14,100	13,200/13,000	10.3/10.3	3.2/3.2	230/208

AZ65 SERIES 265V

PREMIUM GUARD SEACOAST PROTECTION

	Cooling BTU	Heating BTU	EER	COP*	Volts
AZ65H07EAC	7,000	6,200	12.8	3.9	265
AZ65H09EAC	9,500	8,100	11.7	3.6	265
AZ65H12EAC	11,500	10,000	11.2	3.5	265
AZ65H15EAC	14,000	13,200	10.0	3.1	265

INTERNAL CONDENSATE REMOVAL

	Cooling BTU	Heating BTU	EER	COP*	Volts
AZ65H07EAD	7,000	6,200	12.8	3.9	265
AZ65H09EAD	9,500	8,100	11.7	3.5	265
AZ65H12EAD	11,600	10,000	11.4	3.4	265
AZ65H15EAD	14,200	13,300	10.3	3.2	265

Specifications subject to change.

*Coefficient of Performance

ELECTRICAL CONNECTION/SUB-BASE

GE ZONELINE SPECIFICATION — RESISTANCE HEATER WATTAGE

The correct kit for the installation is determined by the voltage and amperage of the electrical circuit and the means of connecting the unit to the building wiring. If the unit is to be plugged into a receptacle, a line cord kit would be used; if the unit is to be permanently connected, a direct connect or permanent connection kit would be used. Cord set units of 265 volts must be installed in compliance with National Electrical Code. (Article 440.60)

POWER CONNECTION KITS

Required on all models. See specification information below for heater kWh and branch circuit ampacity.

GE Zonline offers short and long power cords, direct connect universal supply kits and sub bases. Power connection kits are required for all models. See pages 11 and 12 for all product options.

Receptacles/Sub-bases



Tandem
230/208V 15 Amp
NEMA6-15R



Perpendicular
230/208V 20 Amp
NEMA6-20R



Large tandem
230/208V 30 Amp
NEMA6-30R



265V 15 amp
NEMA7-15R;
receptacle used on
265V sub-base



265V 20 amp
NEMA7-20R;
receptacle used on
265V sub-base



265V 30 amp
NEMA7-30R;
receptacle used on
265V sub-base

GE ZONELINE SPECIFICATIONS—RESISTANCE HEATER WATTAGE

BTUh size	230/208-Volt Line-Cord Connected (P) and Direct Connected Units (D)					
	7,000/9,000			12,000/15,000		
Power connection kit	RAK315P & RAK315D	RAK320P & RAK320D	RAK330P & RAK330D	RAK315P & RAK315D	RAK320P & RAK320D	RAK330P & RAK330D
Total watts	2,410/1,990	3,420/2,830	4,830/3,990*	2,430/2,020	3,450/2,860	4,860/4,020*
Heater watts	2,400/1,960	3,400/2,780	4,800/3,930*	2,400/1,960	3,400/2,780	4,800/3,930*
Heater BTUh	8,100/6,600	11,600/9,400	16,300/13,400*	8,100/6,600	11,600/9,400	16,300/13,400*
Total amps	10.5/9.6	14.9/13.6	21.0/19.2	10.6/9.7	15.1/13.8	21.2/19.3
MCA	15	20	25	15	20	25
Recommended protective device (MOCP)	15 amp time-delay fuse or breaker	20 amp time-delay fuse or breaker	30 amp time-delay fuse or breaker	15 amp time-delay fuse or breaker	20 amp time-delay fuse or breaker	30 amp time-delay fuse or breaker

BTUh size	265-Volt Permanent (P, Cord Set) and Direct-Connected Units (D)					
	7,000/9,000			12,000/15,000		
Power connection kit	RAK515P & RAK515D	RAK520P & RAK520D	RAK530P & RAK530D	RAK515P & RAK515D	RAK520P & RAK520D	RAK530P & RAK530D
Total watts	2,440	3,450	4,850*	2,460	3,470	4,870*
Heater watts	2,400	3,400	4,800*	2,400	3,400	4,800*
Heater BTUh	8,100	11,600	16,300*	8,100	11,600	16,300*
Total amps	9.1	12.9	18.1	9.3	13.1	18.4
MCA	15	20	25	15	20	25
Recommended protective device (MOCP)	15 amp time-delay fuse or breaker	20 amp time-delay fuse or breaker	25 amp time-delay fuse or breaker	15 amp time-delay fuse or breaker	20 amp time-delay fuse or breaker	25 amp time-delay fuse or breaker

Each line cord kit has an integral Leakage Current Detection and Interruption (LCDI) device as required by National Electrical Code (NEC) and Underwriters Laboratories (UL) for units manufactured after August 1, 2004.

Specifications subject to change.
Total watts and total amps include electric heat and fan motor(s).
RAK515P, RAK520P and RAK530P are only to be used with a sub-base.
*30 AMP heater wattage will be reduced in low fan operation.

DELIVERING RELIABLE COMFORT.

Only genuine parts and accessories from GE Appliances keep your Zonline® units running in peak condition.

Engineered and constructed from high-quality materials for a guaranteed fit, convenient replacement and constant comfort.



- RAB71B
WALL SLEEVE** (While Quantities Last)
- Universal design
 - Galvanized steel
 - Expanded polystyrene foam insulation
 - Baked-on enamel
 - Protected with a sealing compound to prevent rust

Also available with extended depths
RAB7116B: 16" deep
RAB7118B: 18" deep
RAB7120B: 20" deep
RAB7124B: 24" deep



- RAB81
QUICK SNAP WALL SLEEVE**
- Universal design
 - Insulated top & sides
 - Heavy gauge metal
 - Color matched
 - 4-piece "quick snap" design
 - **Ships flat (3" H x 15" D x 45.5" L) assembled in field**

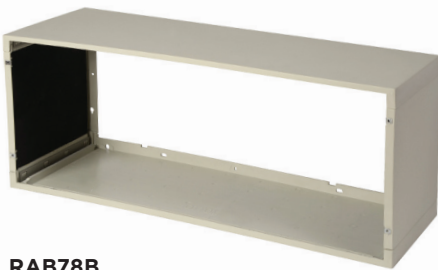

- RAB78B
4 PIECE QUICK SNAP DESIGN SMC SLEEVE
42" EXTENDED DEPTH**
- Stainless steel locking components
 - Fiberglass reinforced polyester compound
 - Color matched and standard size
 - Insulated top and sides



**RAB8116B
QUICK SNAP WALL SLEEVE 16" EXTENDED DEPTH**

Other extended depths available:
RAB8118B: Quick Snap Wall Sleeve 18" extended depth
RAB8120B: Quick Snap Wall Sleeve 20" extended depth
RAB8124B: Quick Snap Wall Sleeve 24" extended depth



- RAB81B
WALL SLEEVE**
- Universal design
 - Insulated top & sides
 - Heavy gauge metal
 - Color matched
 - 4-piece "quick snap" design
 - **Ships fully assembled**

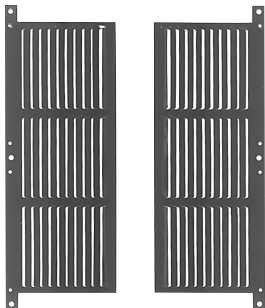

**RAK40
AIR DEFLECTOR KIT**

- Adapts AZ chassis for use with other non-GE architectural grilles
- Aluminum deflector installed to condenser end sheet flanges to prevent condenser airflow recirculation

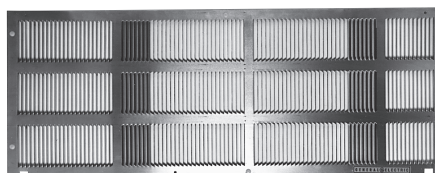

**RAG60
STAMPED ALUMINUM EXTERIOR REAR GRILLE**

- Optimizes air flow
- Made of durable aluminum



**RAG61/62/63
ARCHITECTURAL REAR GRILLE**

- Improves appearance and protection
- Molded of high-impact polycarbonate
- Slightly textured, colorfast surface blends with most walls
RAG61: Beige | RAG62: Maple | RAG63: Dark Brown

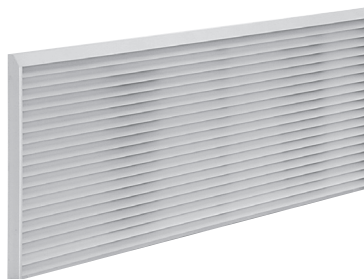

**RAG67
ALUMINUM ARCHITECTURAL OUTDOOR GRILLE**

- Extruded aluminum outdoor grille
- Grilles are paintable to match building décor

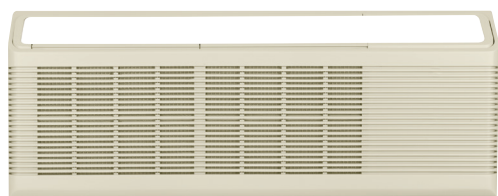

**WP71X20960
REPLACEMENT ROOM CABINET**

- Wraparound design with textured finish
- Injection-molded with high-impact polystyrene
- Fastens to chassis without tools or hardware
- Includes slide-out filters for AZ45/65 series
- Available through geapplianceparts.com

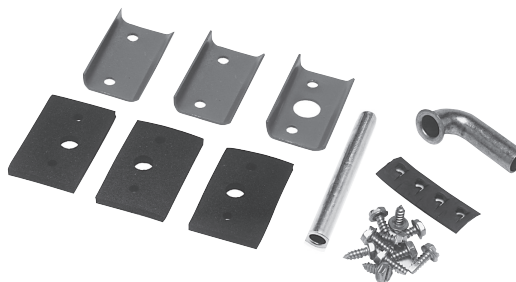

**RAD10
(ALL ZONELINE SERIES)
INTERNAL/EXTERNAL DRAIN KIT**

- Provides positive control of condensate water
- Routes condensate to exterior or interior of the building
- Suitable provision (field applied) required for connection to drain system
- 1/2" OD copper assemblies
- Includes short right-angle tube and 3"-long straight tube



RAK44 (5 Pack)

PTAC CURTAIN GUARD

- Durable polycarbonate
- UV Resistant
- 125 degrees air deflection angle
- Easy to install with no tools needed
- Attaches with pressure sensitive adhesive



RAK6053 (New Installations)

DUCT ADAPTER

- For use with new ducted installations
- Allows Zoneline unit to heat or cool an adjacent room
- Attaches to top of wall case
- Can direct air to the left or right side of adapter with RAK601B extension



RAK7023

**DUCT TRANSITION FOR REPLACEMENT OF EXISTING ZONELINES
7-3/32" H x 6-1/2" W DUCTWORK**

- Allows existing duct adapter and extension to be used without requiring relocation of wall hole



RAK7013

DUCT ADAPTER FOR NEW UNITS WITH OLD DUCTWORK THAT MEASURES 8-3/8" H x 6-1/2" W

- For use with existing ducted installations where ductwork dimensions match those shown about (prior to 1998)
- Allows existing duct extension to be used without requiring relocation of wall hole
- **Must use discharge grille, end plate and extension mounting hardware from old duct adapter**



RAK601B (Includes one RAK602B)

DUCT EXTENSION, REGISTER & TRIM FLANGE

- 44" long
- Includes air register and trim flange (RAK602B) for secondary space
- Additional air register and trim flange can be ordered separately if two extensions are made
- For use with RAK6053

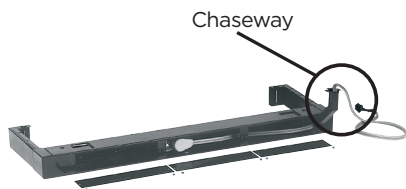

RAK204D*
230/208 SUB-BASES WITH POWER CORD INCLUDED

- Made of heavy-gauge steel
- Full base enclosure with adjustable side channels
- 4-point leveling legs
- Sub-base adapts to service conduit, circuit breakers and receptacles up to 30 amps
- 4-pin connector

Kit No.	Sub-Base	Circuit Ampacity	Chaseway	Power Cord
RAK204D15C	Sub-Base 230V/208V	15	Included	Included
RAK204D20C	Sub-Base 230V/208V	20	Included	Included
RAK204D30C	Sub-Base 230V/208V	30	Included	Included

*Requires the purchase of the RAK4002D Junction box



RAK205CW
CHASEWAY

- For wiring containment between junction box on chassis and RAK204U sub-base

Available while quantities last



RAK204E
265V SUB-BASES WITH POWER CORD INCLUDED

- Made of heavy-gauge steel
- Full base enclosure with adjustable side channels
- 4-point leveling legs
- Sub-base adapts to service conduit, circuit breakers and receptacles up to 30 amps
- 4-pin connector

Kit No.	Sub-Base	Circuit Ampacity	Chaseway	Power Cord
RAK204E15C	Sub-Base 265 V	15	Included	Included
RAK204E20C	Sub-Base 265 V	20	Included	Included
RAK204E30C	Sub-Base 265 V	30	Included	Included

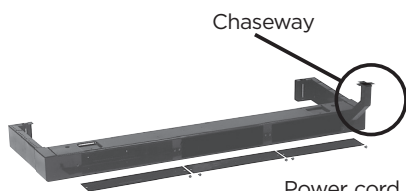

Power cord and junction box not included with sub-base.

RAK204
SUB-BASES

- Made of heavy-gauge steel
- Full base enclosure with breakaway side channels
- 4-point leveling legs
- Sub-base adapts to service conduit, circuit breakers and includes receptacles up to 30 amps
- Used as a non-electrical sub-base to support the unit

Kit No.	Sub-Base	Circuit Ampacity	Chaseway	Power Cord
RAK204U	Standard	N/A	Included	Not Included
RAK204E15*	Sub-Base 265V	15	Included	Not Included
RAK204E20*	Sub-Base 265V	20	Included	Not Included
RAK204E30*	Sub-Base 265V	30	Included	Not Included

* Available while quantities last



RAK204SW
DISCONNECT SWITCH FOR USE IN SUB-BASE

- Fits directly into sub-base
- Comes with switch pre-mounted in replacement plate and wiring shown.
- DPST switch rated for use in 230/208 volt and 265-volt sub-bases
- For use on 15, 20, and 30-amp applications



RAK315P/320P/330P[†]
 RAK320P shown
230/208-VOLT UNIVERSAL POWER CORD KIT

- Six-foot power cord with **LCDI**
- 4-pin connector
- Low-voltage personality plug on 20 amp and 30 amp kits

Kit No.	Volts	Heater Wattage	Circuit Ampacity	
RAK315P	230/208	2.4/1.96 kw	15	
RAK320P	230/208	3.4/2.8 kw	20	
RAK330P	230/208	4.8/3.99 kw	30	



RAK315SP/320SP/330SP[†]
 RAK315SP shown
230/208-VOLT UNIVERSAL SHORT POWER CORD KIT

- Three-foot power cord **WITHOUT LCDI**
- 4-pin connector
- Low-voltage personality plug on 20 amp and 30 amp kits
- Only for use in 230/208 volt sub-bases with new AZ45/65 units
- Requires the purchase of RAK4002D junction box

Kit No.	Volts	Heater Wattage	Circuit Ampacity	
RAK315SP	230/208	2.4/1.96 kw	15	
RAK320SP	230/208	3.4/2.8 kw	20	
RAK330SP	230/208	4.8/3.99 kw	30	



RAK515P/520P/530P[†]
 RAK520P shown
265 VOLTS UNIVERSAL POWER SUPPLY

- Three-foot power cord **WITHOUT LCDI**
- 4-pin connector
- Low-voltage personality plug on 20 amp and 30 amp kits
- Only for use in 265 volt sub-bases with new AZ45/65 units

Kit No.	Volts	Heater Wattage	Circuit Ampacity	
RAK515P	265	2.4 kw	15	
RAK520P	265	3.4 kw	20	
RAK530P	265	4.8 kw	30	

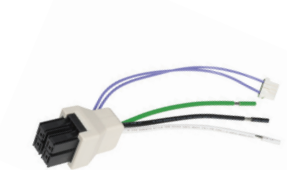

RAK315D/320D/330D[†]
 RAK320D shown
230/208-VOLT DIRECT CONNECT POWER SUPPLY KIT

- 4-pin connector with three 7" 12-gauge conductor wires and low-voltage personality plug on 20 amp and 30 amp kits
- Requires the purchase of RAK4002D junction box

Kit No.	Volts	Heater Wattage	Circuit Ampacity
RAK315D	230/208	2.4/1.99 kw	15
RAK320D	230/208	3.4/2.8 kw	20
RAK330D	230/208	4.8/3.99 kw	30

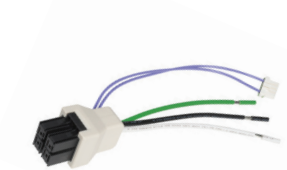

RAK515D/520D/530D[†]
 RAK520D shown
265-VOLT UNIVERSAL DIRECT CONNECT POWER SUPPLY KIT

- 4-pin connector with three 7" 12-gauge conductor wires and low-voltage personality plug on 20 amp and 30 amp kits

Kit No.	Volts	Heater Wattage	Circuit Ampacity
RAK515D	265	2.4 kw	15
RAK520D	265	3.4 kw	20
RAK530D	265	4.8 kw	30

[†]Heater wattage may vary slightly among models. 30-amp heater wattage is reduced in low fan operation.

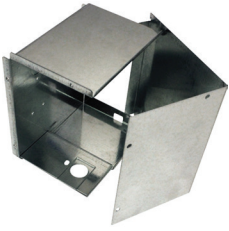

**RAK4002D
DIRECT-CONNECT JUNCTION BOX
WIRING (230/208 & 265 VOLTS)**

- Kit for direct connection of 230/208-volt and 265-volt units to building power supply (via sub base or direct connect)
- Junction box is included on 265-volt units
- Used on models ending in W5 or higher (made after April 2019)

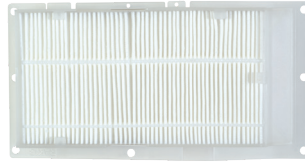

**RAK13
MERV 13 MAKEUP AIR FILTER KIT**

- When required by code for Makeup Air Products (California 01-01-2020)
- Includes one filter
- Replacement filter RAA13 sold separately



**RAA64
REPLACEMENT FILTERS**

- One pair per box
- Sold in pairs
- Conveniently accessible through the front of the unit

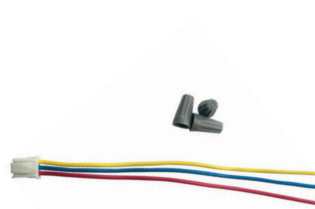

**RAKCDC
CDC WIRING CONNECTOR**

- 3-wire connector
- Works with Central Desk Control system and through wall fan option
- External fan option
- For use with DBM/EBM Makeup Air units and approved occupancy sensing thermostats

ZONELINE® THERMOSTATS

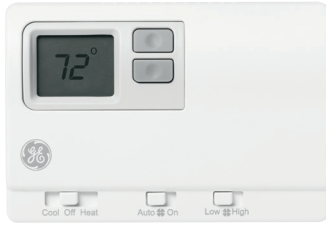

RAK149F2

- Two fan speed Dual use Digital thermostat
- Can be set up for Single or Two stage heat (AZ45 or AZ65)
- 24V AC wired remote wall thermostat
- Heat pump configured as default
- Requires 6-wire hookup for single stage heat and 7-wires for two stage heat

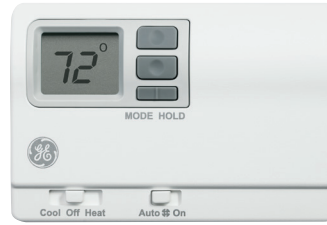

RAK149P2

- Programmable Dual use Digital thermostat
- Can be set up for Single or Two stage heat (AZ45 or AZ65)
- Programmable for 7-day or 5+2-day programs
- 24V AC wired remote wall thermostat
- Heat pump configured as default
- Requires 5-wire hookup for single stage heat and 6-wires for two stage heat



RAK180W1

ENERGY MANAGEMENT OCCUPANCY SENSING WIRED/WIRELESS THERMOSTAT MAKEUP AIR COMPATIBLE

- 2-wire power connection available (all other signals wireless)
- Thermostat (shown) and control card (mounts under Zoneline cover) included
- Control card works off 24 Volt AC or DC signal from unit
- Works with single-stage cooling and single-stage or two-stage heating systems with proper set up. Default is two stage heating and B type heat pump
- Extra 24V relay for controlling GE Zoneline Makeup Air duct door when room is unoccupied for additional energy savings
- Output may be programmed to control other room systems such as lighting, vents, etc.



WALL THERMOSTAT

When installed with a remote Thermostat, the PTAC special feature display illuminates automatically a message (Use Wall Thermostat). The LED will dim down after a few seconds and then turn off after a few minutes as to not disturb the guest in a dark room.

Other thermostats are available, call your GE representative for more details.

ZONELINE® ACCESSORIES

NUMBER	DESCRIPTION
RAA62	Replacement filters for AZ models (10 pairs per box) for 22, 32 & 52 only
RAA62A	Replacement filters (10 pairs per box) for 25, 35 & 55 only
RAA63	Replacement filters (10 pairs per box) for 28, 38, 41, 58, & 61 only
RAA64	Replacement filters (one pair per box) for 45 & 65 only
RAB71B	Wall sleeve, 45 & 65 only
RAB7116	Wall sleeve, 16" (Color prior to AZ45/65 Series)
RAB7124	Wall sleeve, 24" (Color prior to AZ45/65 Series)
RAB7128	Wall sleeve, 28" (Color prior to AZ45/65 Series)
RAB7131	Wall sleeve, 31" (Color prior to AZ45/65 Series)
RAB7116B	Wall sleeve, 16", 45 & 65 only
RAB7118B	Wall Sleeve, 18" 45 & 65 only
RAB7120B	Wall Sleeve, 20" 45 & 65 only
RAB7124B	Wall sleeve, 24", 45 & 65 only
RAB77B	SMC wall sleeve, 45 & 65 only
RAB78B	SMC four piece Quick Snap wall sleeve
RAB81	Wall Sleeve-ships flat- 4 piece snap together 42x16x13 3/4
RAB81B	Wall Sleeve-fully assembled 4 piece snap together 42x16x13 3/4
RAB8116B	Quick Snap Wall Sleeve 16" extended depth
RAB8118B	Quick Snap Wall Sleeve 18" extended depth
RAB8120B	Quick Snap Wall Sleeve 20" extended depth
RAB8124B	Quick Snap Wall Sleeve 24" extended depth
RAD10	Internal/external drain kit
RAF452	Replacement room cabinet (2-position louvers) for 22, 32 & 52 only
RAF452A	Replacement room cabinet (2-position louvers) for 25, 35 & 55 only
RAF453A	Replacement room cabinet (2-position louvers) for 28, 29, 38, 39, 41, 58 and 61 only
RAF454	Replacement room cabinet (2-position louvers) for 45 & 65 only
RAG60	Stamped aluminum exterior rear grille
RAG61	Architectural rear grille, beige
RAG62	Architectural rear grille, maple
RAG63	Architectural rear grille, dark brown
RAG67	Aluminum architectural outdoor grille
RAK40	Air deflector kit
RAK44	PTAC Curtain Guard (5 Pack)
RAK4002A	Direct-connect junction box 230/208V for 25, 35, 28, 29, 38, 39, 41, 45, 61 & 65 only
RAK4002B	Direct-connect junction box 230/208V for 55, 58 only
RAK4002C	Direct-connect junction box, 230/208V and 265V for 45 & 65 Models ending in W4 or lower
RAK4002CW	Direct-connect junction box wiring, 230/208V and 265V (excludes 45 & 65)
RAK4002D	Direct-connect junction box 230/208V for 45 & 65 models ending in W5 or higher
RAK315P	Universal power supply, 15 amp for 45 & 65 only with 6' power cord
RAK320P	Universal power supply, 20 amp for 45 & 65 only with 6' power cord
RAK330P	Universal power supply, 30 amp for 45 & 65 only with 6' power cord
RAK315D	230/208V Universal power supply, 15 amp for 45 & 65 only
RAK320D	230/208V Universal power supply, 20 amp for 45 & 65 only
RAK330D	230/208V Universal power supply, 30 amp for 45 & 65 only
RAK515D	265V Universal power supply, short 15 amp for 45 & 65 only
RAK520D	265V Universal power supply, short 20 amp for 45 & 65 only
RAK530D	265V Universal power supply, short 30 amp for 45 & 65 only
RAK315SP	230/208V Universal power supply, short, 15 amp for 45 & 65 only, 3' cord for sub-base use only
RAK320SP	230/208V Universal power supply, short, 20 amp for 45 & 65 only, 3' cord for sub-base use only
RAK330SP	230/208V Universal power supply, short, 30 amp for 45 & 65 only, 3' cord for sub-base use only
RAK515P	265V Universal power supply, 15 amp for 45 & 65 only, 3' cord for sub-base use only
RAK520P	265V Universal power supply, 20 amp for 45 & 65 only, 3' cord for sub-base use only
RAK530P	265V Universal power supply, 30 amp for 45 & 65 only, 3' cord for sub-base use only

ZONELINE® ACCESSORIES

NUMBER	DESCRIPTION
RAK205CW	Chaseway for RAK204U sub-base
RAK204D15C	230/208V, 15 amp sub-base with power cord, 45 & 65 only
RAK204D20C	230/208V, 20 amp sub-base with power cord, 45 & 65 only
RAK204D30C	230/208V, 30 amp sub-base with power cord, 45 & 65 only
RAK204E15	265V, 15 amp sub-base with outlet included
RAK204E20	265V, 20 amp sub-base with outlet included
RAK204E30	265V, 30 amp sub-base with outlet included
RAK204E15C	265V, 15 amp sub-base with power cord, 45 & 65 only
RAK204E20C	265V, 20 amp sub-base with power cord, 45 & 65 only
RAK204E30C	265V, 30 amp sub-base with power cord, 45 & 65 only
RAK204U	Sub-base without electrical devices or wiring
RAK601B	Duct extension for 45 & 65 only (Includes RAK602B)
RAK602B	Air register and trim flange for 45 & 65 only
RAK6052	Duct adapter for 22, 32, 25, 35, 28, 29, 38, 39, 41 & 61 only (Color prior to AZ45/65 Series)
RAK6053	Duct adapter for new installations 45 & 65 only
RAK7013	Duct adapter AZ45/65 with existing ductwork measuring 8 3/8" H x 6 1/2" W
RAK7023	Duct transition for replacement of new units and existing ductwork measuring 7 3/32" x 6 1/2" W for 45 & 65 only
RAK8023	Locking door kit for 28, 29, 38, 39, 41, 58 & 61 only
RAK806	Universal cover label (10 covers per kit), excludes 45 & 65
RAK901L	Wall case insulation kit (While supplies last)
RAKCDC	CDC Wiring Connector for 45 & 65 only (Also used with occupancy thermostats for Makeup Air)
RAA13	Replacement filter for RAK13
RAK13	MERV 13 filter kit for Makeup Air models (California 1-1-2020)

THERMOSTATS

NUMBER	DESCRIPTION
RAK149F2	Single stage and two stage digital 2 fan speed remote thermostat
RAK149P2	Single stage and two stage programmable remote thermostat
RAK180W1	Energy management/occupancy sensing wireless thermostat - Makeup Air compatible

ZONELINE® PACKAGED TERMINAL AIR CONDITIONER SPECIFICATIONS

AZ45 SERIES 230V/208V

AZ45 series (typical) cooling with electric heat

230/208V Models	AZ45E07DAB	AZ45E09DAB	AZ45E12DAB	AZ45E15DAB
Cooling BTUH	7,200/7,000	9,700/9,600	11,600/11,500	14,200/14,100
EER (BTU/Watt)	13.4/13.4	12.1/12.1	11.7/11.8	10.5/10.5
Dehumidification Pts/Hr	1.64	2.7	3.5	4.6
Refrigerant type	R-410A	R-410A	R-410A	R-410A
CFM, indoor fan high	350	390	420	435
CFM, indoor fan low	220	260	290	330
Vent CFM (full open)*	33	38	38	47
Power factor	96%	98%	98%	97%
Sensible heat ratio @ 230 volts	72%	64%	62%	63%
Cooling Watts	535/520	800/790	960/900	1,350/1,320
Total Cooling Amperes, F.L.	2.5/2.6	3.6/3.9	4.7/5.0	6.4/6.8
Amperes, L.R.	13.5	21.0	29.5	31.5
Weight (Net/Ship)	90/100	103/113	106/116	106/116

AZ45 series cooling with electric heat (Premium Guard Seacoast Protection)

230/208V Models	AZ45E07DAC	AZ45E09DAC	AZ45E12DAC	AZ45E15DAC
Cooling BTUH	7,200/7,000	9,400/9,300	11,600/11,500	14,600/14,500
EER (BTU/Watt)	13.4/13.4	11.8/11.8	11.7/11.8	10.3/10.4
Dehumidification Pts/Hr	1.64	2.7	3.5	4.6
Refrigerant type	R-410A	R-410A	R-410A	R-410A
CFM, indoor fan high	350	390	420	435
CFM, indoor fan low	220	260	290	330
Vent CFM (full open)*	33	38	38	47
Power factor	96%	98%	98%	97%
Sensible heat ratio @ 230 volts	72%	64%	62%	63%
Cooling Watts	535/520	795/790	985/955	1,390/1,380
Total Cooling Amperes, F.L.	2.5/2.6	3.5/3.9	4.4/4.7	6.3/6.7
Amperes, L.R.	13.5	21	29.5	31.5
Weight (Net/Ship)	90/100	103/113	106/116	106/116

AZ45 series cooling with electric heat (Dry Air 25)

230/208V Models	AZ45E07DAP	AZ45E09DAP	AZ45E12DAP
Cooling BTUH	6,900/6,800	9,400/9,300	11,200/11,100
EER (BTU/Watt)	12.8/12.8	12.1/12.1	11.4/11.5
Dehumidification Pts/Hr	2.4	3.4	4.2
Refrigerant Type	R-410A	R-410A	R-410A
CFM, indoor fan high	350	370	360
CFM, indoor fan low	220	260	270
Vent CFM (full open)*	40.0	44.0	44
Power factor	96%	97%	98%
Sensible heat ratio @ 230 volts	59%	58%	54%
Cooling Watts	535/530	775/765	970/960
Total Cooling Amperes, F.L.	2.5/2.7	3.5/3.8	4.4/4.7
Amperes, L.R.	13.5	21.0	29.5
Weight (Net/Ship)	96/106	109/119	112/122

AZ45 series cooling with electric heat (Makeup Air)

230/208V Models	AZ45E09DBM	AZ45E12DBM
Cooling BTUH	9,100/9,100	11,900/11,700
EER (BTU/Watt)	11.5/11.5	11.7/11.7
Dehumidification Pts/Hr	2.4	3.9
Refrigerant type	R-410A	R-410A
CFM, indoor fan high	409	449
CFM, indoor fan low	280	270
Vent CFM	25-50	25-50
Power factor	98%	98%
Sensible heat ratio @ 230 volts	75%	66%
Cooling Watts	790/790	1,005/1,000
Total Cooling Amperes, F.L.	5.1/5.2	5.7/6.0
Amperes, L.R.	21.0	29.5
Weight (Net/Ship)	122/132	123/133

Specifications subject to change.

NOTE: Resistance heater wattage and amperage dependent on power connection kit. See page 6.

*Using RAKVENT1 kit



Listed by Underwriters Laboratories



AZ65 SERIES 230V/208V

AZ65 series heat pump with backup electric heat

230/208V Models	AZ65H07DAB	AZ65H09DAB	AZ65H12DAB	AZ65H15DAB
Cooling BTUH	7,100/6,900	9,700/9,600	11,900/11,800	14,400/14,200
EER (BTU/Watt)	13.0/13.0	12.2/12.2	11.6/11.8	10.5/10.5
Dehumidification Pts/Hr	1.7	2.6	3.7	4.8
Refrigerant type	R-410A	R-410A	R-410A	R-410A
CFM, indoor fan high	360	420	410	400
CFM, indoor fan low	205	300	300	290
Vent CFM (full open)*	38	40	45	44
Power factor	96%	98%	98%	97%
Sensible heat ratio @ 230 volts	79%	68%	62%	60%
Cooling Watts	545/530	795/785	1,020/995	1,365/1,340
Total Cooling Amperes, F.L.	2.5/2.7	3.6/3.8	4.6/4.9	6.2/6.6
Amperes, L.R.	13.5	21.0	29.5	31.5
Reverse cycle heat BTUH	6,200/6,100	8,100/8,000	10,400/10,300	13,500/13,300
Coefficient of Performance	4.0/4.0	3.7/3.7	3.6/3.6	3.2/3.2
Heat Pump Watts	450/440	645/630	845/835	1,195/1,160
Heat Pump Amperes	2.1/2.2	3.0/3.2	3.8/4.0	5.4/5.7
Weight (Net/Ship)	98/108	104/114	104/114	107/117

AZ65 (typical) series heat pump with backup electric heat (Premium Guard Seacoast Protection)

230/208V Models	AZ65H07DAC	AZ65H09DAC	AZ65H12DAC	AZ65H15DAC
Cooling BTUH	7,100/7,000	9,600/9,500	11,800/11,600	14,400/14,200
EER (BTU/Watt)	13.0/13.0	12.2/12.2	11.8/11.8	10.4/10.4
Dehumidification Pts/Hr	1.6	2.6	3.7	4.8
Refrigerant type	R-410A	R-410A	R-410A	R-410A
CFM, indoor fan high	360	420	410	400
CFM, indoor fan low	205	300	300	290
Vent CFM (full open)*	38	40	45	44
Power factor	96%	98%	98%	97%
Sensible heat ratio @ 230 volts	73%	68%	62%	60%
Cooling Watts	545/535	795/785	995/975	1,365/1,365
Total Cooling Amperes, F.L.	2.5/2.7	3.6/3.9	4.5/4.9	6.2/6.7
Amperes, L.R.	13.5	21.0	29.5	31.5
Reverse cycle heat BTUH	6,200/6,100	8,100/8,000	10,300/10,200	13,200/13,000
Coefficient of Performance	4.0/4.0	3.7/3.7	3.6/3.6	3.2/3.2
Heat Pump Watts	450/445	645/630	835/815	1,205/1,180
Heat Pump Amperes	2.1/2.2	2.9/3.1	3.8/4.0	5.5/5.8
Weight (Net/Ship)	98/108	106/116	104/114	108/118

AZ65 series heat pump with backup electric heat (Internal Condensate Removal)

230/208V Models	AZ65H07DAD	AZ65H09DAD	AZ65H12DAD	AZ65H15DAD
Cooling BTUH	7,000/6,900	9,600/9,500	11,800/11,600	14,300/14,100
EER (BTU/Watt)	13.0/13.0	12.0/12.0	11.5/11.5	10.3/10.3
Dehumidification Pts/Hr	1.6	2.6	3.7	4.8
Refrigerant type	R-410A	R-410A	R-410A	R-410A
CFM, indoor fan high	360	420	410	400
CFM, indoor fan low	205	300	300	290
Vent CFM (full open)*	38.0	40.0	45.0	44.0
Power factor	96%	98%	98%	97%
Sensible heat ratio @ 230 volts	73%	68%	62%	60%
Cooling Watts	535/530	800/790	1,020/1,005	1,385/1,360
Total Cooling Amperes, F.L.	2.5/2.7	3.6/3.9	4.5/4.9	6.1/6.6
Amperes, L.R.	13.5	21.0	29.5	31.5
Reverse cycle heat BTUH	6,200/6,000	8,200/8,000	10,400/10,200	13,500/13,400
Coefficient of Performance	4.0/4.0	3.6/3.6	3.5/3.5	3.2/3.2
Heat Pump Watts	450/435	665/650	870/850	1,235/1,225
Heat Pump Amperes	2.1/2.2	3.0/3.2	3.8/4.9	5.3/5.6
Weight (Net/Ship)	100/110	108/118	106/116	110/120

AZ65 series heat pump with backup electric heat (Makeup Air)

230/208V Models	AZ65H07DBM	AZ65H09DBM	AZ65H12DBM	AZ65H15DBM
Cooling BTUH	7,000/7,000	9,200/9,100	11,500/11,400	14,000/13,000
EER (BTU/Watt)	12.5/12.5	11.3/11.3	11.2/11.2	10.1/10.1
Dehumidification Pts/Hr	0.9	1.9	3.4	4.8
Refrigerant type	R-410A	R-410A	R-410A	R-410A
CFM, indoor fan high	409	409	449	400
CFM, indoor fan low	250	300	300	290
Vent CFM	25-50	25-50	25-50	25-50
Power factor	96%	97%	97%	97%
Sensible heat ratio @ 230 volts	89%	80%	69%	60%
Cooling Watts	560/560	810/805	1,025/1,015	1,370/1,350
Total Cooling Amperes, F.L.	3.7/3.9	4.9/5.2	5.8/6.2	6.2/6.6
Amperes, L.R.	13.5	21.0	29.5	31.5
Reverse cycle heat BTUH	6,200/6,100	8,000/7,900	10,200/10,000	13,200/13,000
Coefficient of Performance	4.0/4.0	3.3/3.3	3.5/3.5	3.2/3.2
Heat Pump Watts	450/440	705/695	850/835	1,200/1,180
Heat Pump Amperes	3.3/3.4	4.7/4.8	5.0/5.2	5.4/5.7
Weight (Net/Ship)	117/127	123/133	123/133	126/136

ZONELINE® PACKAGED TERMINAL AIR CONDITIONERS SPECIFICATIONS

AZ45 SERIES 265V

AZ45 series cooling with electric heat (Premium Guard Seacoast Protection)

265V Models	AZ45E07EAC	AZ45E09EAC	AZ45E12EAC	AZ45E15EAC
Cooling BTUH	7,100	9,500	11,500	14,700
EER (BTU/Watt)	13.2	11.6	11.7	10.5
Dehumidification Pts/Hr	1.64	2.7	3.5	4.6
Refrigerant type	R-410A	R-410A	R-410A	R-410A
CFM, indoor fan high	350	393	393	435
CFM, indoor fan low	220	260	290	330
Vent CFM (full open)*	33	38	38	47
Power factor	95%	94%	97%	97%
Sensible heat ratio @ 265 volts	72%	67%	62%	63%
Cooling Watts	540	815	990	1,400
Total Cooling Amperes, F.L.	2.2	3.3	4.0	5.5
Amperes, L.R.	11.7	16.5	23.5	29.0
Weight (Net/Ship)	95/105	103/113	106/116	107/117

AZ45 series cooling with electric heat (Dry Air 25)

265V Models	AZ45E09EAP	AZ45E12EAP
Cooling BTUH	9,400	10,900
EER (BTU/Watt)	12.1	11.0
Dehumidification Pts/Hr	3.5	4.2
Refrigerant type	R-410A	R-410A
CFM, indoor fan high	370	360
CFM, indoor fan low	260	270
Vent CFM (full open)*	44	44
Power factor	93%	97%
Sensible heat ratio @ 265 volts	58%	54%
Cooling Watts	780	995
Total Cooling Amperes, F.L.	3.2	3.9
Heating Amperes	16.5	23.5
Weight (Net/Ship)	109/119	112/122

AZ65 SERIES 265V

AZ65 (typical) series heat pump with backup electric heat (Premium Guard Seacoast Protection)

265V Models	AZ65H07EAC	AZ65H09EAC	AZ65H12EAC	AZ65H15EAC
Cooling BTUH	7,000	9,500	11,500	14,200
EER (BTU/Watt)	12.8	11.7	11.2	10.2
Dehumidification Pts/Hr	1.5	2.5	3.7	4.8
Refrigerant type	R-410A	R-410A	R-410A	R-410A
CFM, indoor fan high	360	420	410	400
CFM, indoor fan low	205	300	300	290
Vent CFM (full open)*	38	40	45	44
Power factor	95%	94%	97%	97%
Sensible heat ratio @ 265 volts	77%	68%	62%	60%
Cooling Watts	545	810	1,025	1,390
Total Cooling Amperes, F.L.	2.2	3.3	4.0	5.5
Amperes, L.R.	11.7	16.5	23.5	29.0
Reverse cycle heat BTUH	6,200	8,100	10,000	13,400
Coefficient of Performance	3.9	3.6	3.5	3.3
Heat Pump Watts	460	655	835	1,225
Heat Pump Amperes	1.9	2.8	3.5	4.9
Weight (Net/Ship)	98/108	104/114	104/114	109/119

AZ65 series heat pump with backup electric heat (Internal Condensate Removal)

265V Models	AZ65H07EAD	AZ65H09EAD	AZ65H12EAD	AZ65H15EAD
Cooling BTUH	7,000	9,500	11,600	14,200
EER (BTU/Watt)	12.8	11.7	11.4	10.3
Dehumidification Pts/Hr	1.5	2.5	3.7	4.8
Refrigerant type	R-410A	R-410A	R-410A	R-410A
CFM, indoor fan high	360	420	410	400
CFM, indoor fan low	205	300	300	290
Vent CFM (full open)*	38	40	45	44
Power factor	95%	94%	97%	97%
Sensible heat ratio @ 265 volts	77%	68%	62%	60%
Cooling Watts	545	810	1,015	1,375
Total Cooling Amperes, F.L.	2.2	3.3	4.1	5.5
Amperes, L.R.	11.7	16.5	23.5	29.0
Reverse cycle heat BTUH	6,200	8,100	10,000	13,300
Coefficient of Performance	3.9	3.5	3.4	3.2
Heat Pump Watts	460	670	850	1,210
Heat Pump Amperes	1.9	2.8	3.5	4.9
Weight (Net/Ship)	100/110	106/116	106/116	111/121

AZ65 series heat pump with backup electric heat (Makeup Air)

265V Models	AZ65H07EBM	AZ65H09EBM	AZ65H12EBM
Cooling BTUH	6,900	9,200	11,600
EER (BTU/Watt)	12.5	11.5	11.3
Dehumidification Pts/Hr	0.7	2.0	3.7
Refrigerant type	R-410A	R-410A	R-410A
CFM, indoor fan high	409	409	449
CFM, indoor fan low	350	370	350
Vent CFM	25-50	25-50	25-50
Power factor	93%	93%	96%
Sensible heat ratio @ 230 volts	88%	78%	69%
Cooling Watts	550	800	1,025
Total Cooling Amperes, F.L.	3.2	4.2	4.0
Amperes, L.R.	11.7	16.5	23.5
Reverse cycle heat BTUH	6,000	8,100	10,000
Coefficient of Performance	3.9	3.6	3.4
Heat Pump Watts	450	655	860
Heat Pump Amperes	2.9	3.8	3.5
Weight (Net/Ship)	117/127	123/133	123/133

Specifications subject to change.

NOTE: Resistance heater wattage and amperage dependent on power connection kit. See page 6.

*Using RAKVENT1 kit



Listed by Underwriters Laboratories



HOW TO ORDER

It's easy to order Zonline, and Zonline Parts & Accessories

Call or go online to get the products, parts and accessories you need from GE Appliances.

ZONELINE.COM | GEAPPLIANCES.COM | GEAPPLIANCEPARTS.COM | 844.GE4.PTAC - GE FACTORY SERVICE

ORDER GE APPLIANCES PARTS DIRECT

When you order GE Appliances Parts direct, you'll be backed by quality and support you can count on:

- Original genuine parts
- Limited 1-year warranty
- Discounts and promotions
- Access to illustrated parts catalog
- Check status and availability

Apply for credit, speak to a GE Appliances Parts Specialist or buy genuine GE Appliances Parts at:

GECUSTOMERNET.COM | 800.851.6200

YOUR PRODUCT INFORMATION:

Locate your Zonline's serial number:

- Remove cover
- Find the base pan, located at the bottom of the unit
- Serial number will be printed on the base pan

MY ACCOUNT NUMBER

MY SALES MANAGER

CONTACT US FOR A QUOTE TODAY:

888.231.2548

zonline@geappliances.com



VISIT ZONELINE.COM OR CALL 888.231.2548

ZONELINE® WARRANTY

FOR THE PERIOD OF | GE APPLIANCES WILL REPLACE

ONE YEAR

From the date of the original purchase

Any part of the air conditioner which fails due to a defect in materials or workmanship. During this limited one-year warranty, GE will provide, free of charge, all labor and related service costs to replace the defective part.

FIVE YEARS

From the date of the original purchase

Sealed Refrigerating System - if any part of the Sealed Refrigerating System (the compressor, condenser, evaporator, and all connecting tubing, including the makeup air system) should fail due to a defect in materials or workmanship. During this limited five-year warranty, GE will provide, free of charge, all labor and related service costs to replace the defective part.

SECOND THROUGH FIFTH YEAR

From the date of the original purchase

Fan Motors, Switches, Heater, Heater Protectors, Compressor Overload, Solenoids, Circuit Boards, Auxiliary Controls, Thermistors, Freeze Sentinel, Frost Controls, ICR Pump, Capacitors, Varistors and Indoor Blower Bearing, if any of these parts should fail due to a defect in materials or workmanship. During this additional four-year limited warranty, GE will provide the replacement part free of charge. The customer will be responsible for any labor and related service costs.

ZONELINE® CHASSIS NOMENCLATURE

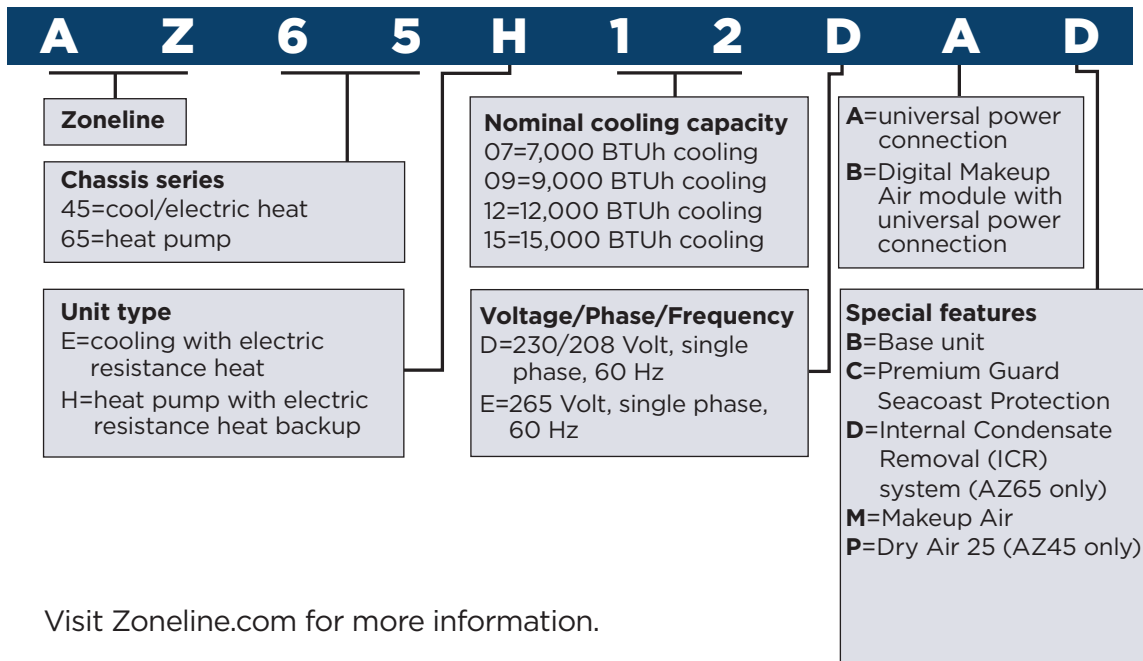

Visit Zoneline.com for more information.





GE APPLIANCES
a Haier company

GE is a trademark of the General Electric Company.
Manufactured under trademark license.

Appliance Park
Louisville, KY 40225
zonline.com

Pub No. 20-S0421
OTGEA21083