

Installation Instructions

36" Electric Cooktop

JP960, JP968, ZEU769

“If you have question, call 800-GE-CARES or visit our website at: www.GEAppliances.com”

CAUTION: Before you begin- read these instructions completely and carefully.

- **IMPORTANT-** Save these instructions for local inspector's use.
- **IMPORTANT-OBSERVE ALL GOVERNING CODES AND ORDINANCES.**
- **Note to Installer-** Be sure to leave these instructions with the Consumer.

- **Note to Consumer-** Keep these instructions for future reference.
- Note- This appliance must be properly grounded.

Parts Included



4 screws

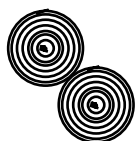

2 Foam strips

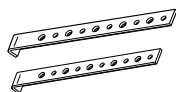

2 Hold Down Brackets

Materials Needed

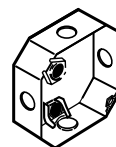

Junction Box



Wire Nuts

Tools You Will Need

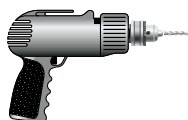

1/8" Drill Bit & Electric or Hand Drill



Phillips Head Screwdriver



Pencil

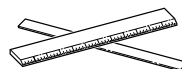

Ruler or Straightedge

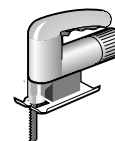

Saber Saw

Installation Instructions

IMPORTANT SAFETY INSTRUCTIONS

For Your Safety

- For Personal Safety remove house fuse or open circuit breaker before beginning installation. Failure to do so could result in serious injury or death.
- Be sure your cooktop is installed properly by a qualified installer or service technician.
- To eliminate the risk of burns or fire due to reaching over heated surface elements, cabinet storage located above the surface units should be avoided. If cabinet storage space is to be provided, the risk can be reduced by installing a range hood that projects horizontally a minimum of 5" beyond the bottom of the cabinets. Cabinet installation above the cooktop may be no deeper than 13".
- Make sure the cabinets and wall coverings around the cooktop can withstand the temperatures (up to 200°F.) generated by the cooktop.
- The cooktop should be easy to reach and lighted with natural light during the day.
- Always disconnect the electrical service to the cooktop before repairing or servicing the cooktop. This can be done by disconnecting the fuse or circuit breaker. Failure to do this could result in a dangerous or fatal shock. Know where your main disconnect switch is located. If you do not know, have your electrician show you.

Electrical Requirements

This appliance must be supplied with the proper voltage and frequency, and connected to an individual, properly grounded branch circuit, protected by a circuit breaker or a time delay fuse as noted on rating plate.

We recommend you have the electrical wiring and hookup of your cooktop connected by a qualified electrician. After installation, have the electrician show you where your main range disconnect is located.

Wiring must conform to National Electrical Code. You can get a copy of the National Electrical Code, ANSI/NFPA No. 70-Latest Edition, by writing:

National Fire Protection Association
Battery March Park
Quincy, MA 02269

The cooktop conduit wiring is approved for copper wire connection only. If you have aluminum house wiring, you must use special UL approved connectors for joining copper to aluminum.

You must use a two-wire, three conductor 208/240 VAC, 60 Hertz electrical system. A white (neutral) wire is not needed for this unit. The cooktop must be installed in a circuit that does not exceed 125 VAC nominal to ground.

Refer to the rating plate on your cooktop for the KW rating for your cooktop.

Installation Instructions

✓ Pre- Installation Checklist



The electrical power to the cooktop supply line must be shut off while connections are being made. Failure to do so could result in serious injury or death.



Remove Installation Instruction from literature pack and read them carefully before you begin. Be sure to place all literature, Use and Care, Installations, etc. in a safe place for future reference.



When preparing cooktop opening, make sure the inside of the cabinet and the cooktop do not interfere with each other. (See section on preparing the opening.)



Remove packaging materials and literature package from the cooktop before beginning installation.



Make sure you have all the tools and materials you need before starting the installation of the cooktop.



Your home must provide the adequate electrical service needed to safely and properly use your cooktop. (Refer to section on electrical requirements.)



When installing your cooktop in your home, make sure all local codes and ordinances are followed exactly as stated.



Make sure the wall coverings, counter top and cabinets around the cooktop can withstand heat (up to 200°F) generated by the cooktop.

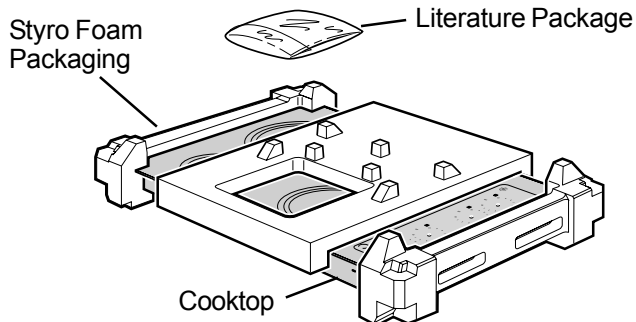

Installation Instructions

A PREPARING THE OPENING

A1 The following MINIMUM clearance dimensions must be maintained.

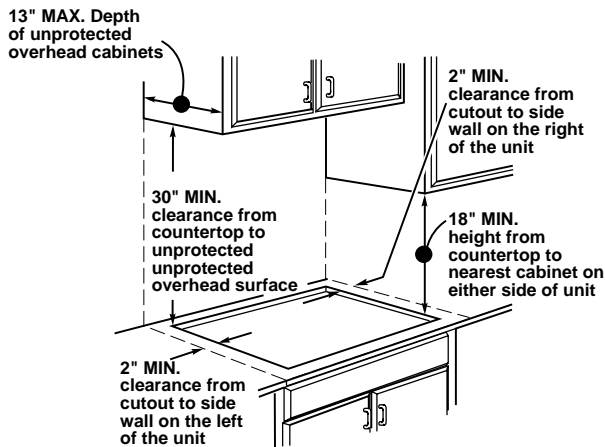

A4 CUTOUT DIMENSIONS OF THE COUNTERTOP

To insure accuracy, it is best to make a template when cutting the opening in the counter.

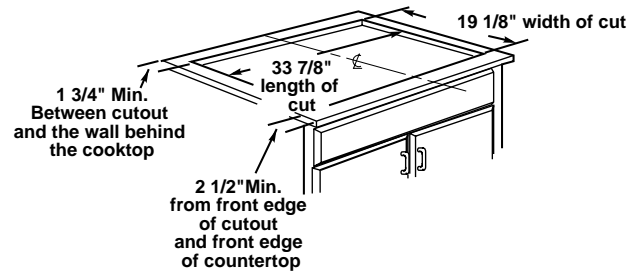

A2 OVERALL COOKTOP DIMENSIONS

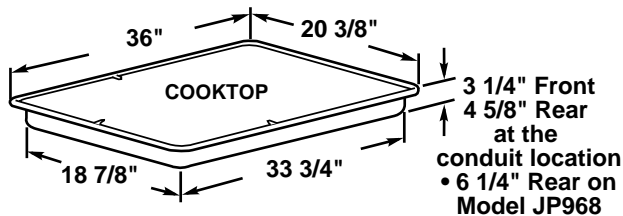

A5 Make sure the wall coverings, counter top and cabinets around the cooktop can withstand heat (up to 200°F) generated by cooktop.

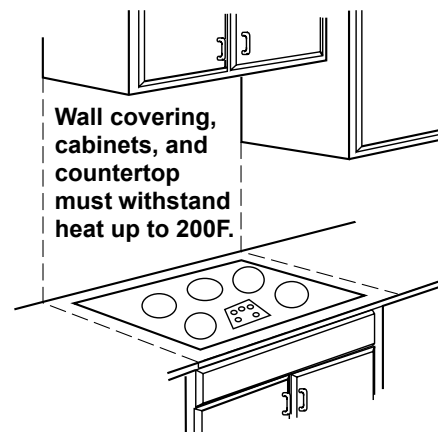

A3 Five inches (5") minimum vertical clearance between the cooktop bottom and any combustible surfaces.

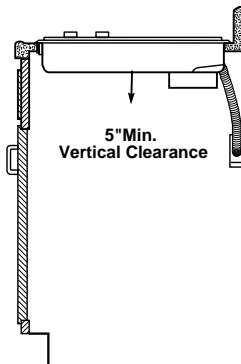

Installation Instructions

B Installing the Cooktop

Installing the Junction Box.

- B1** Install an approved junction box where it will be easily reached through the front of the cabinet where the cooktop will be located. **The cooktop conduit is 3 feet long,**

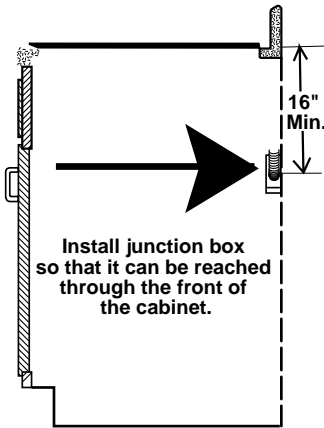

IMPORTANT: The junction box must be located where it will allow considerable slack in the conduit for serviceability.

Protect Surface of Cooktop

- B2** Place a towel or table cloth onto the counter top. Lay the cooktop upside down onto the protected surface.

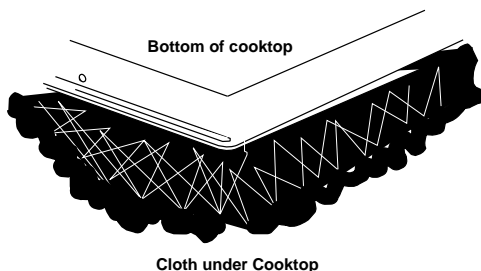

Attach Foam Strips

- B3** Apply the foam strips around the outer edge of the glass. **Do not overlap the foam strips.**

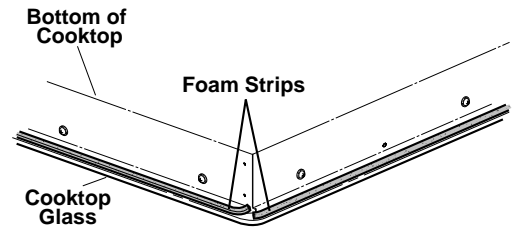

Locate Mounting Parts

- B4** Remove the hold down brackets and screws from the literature package.

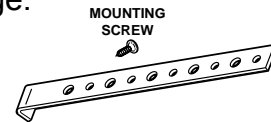

Attach Brackets to Cooktop

- B5** Screw the Hold Down Bracket to the side of the cooktop unit. Repeat for opposite side of cooktop.

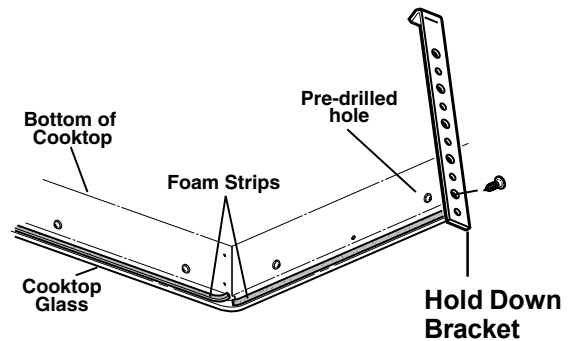

Installation Instructions

B Installing the Cooktop cont.

Insert Cooktop Into Cutout

- B6** Insert the cooktop centered into the cutout opening. Make sure the front edge of the counter top is parallel to the cooktop. Make final check that all required clearances are met.

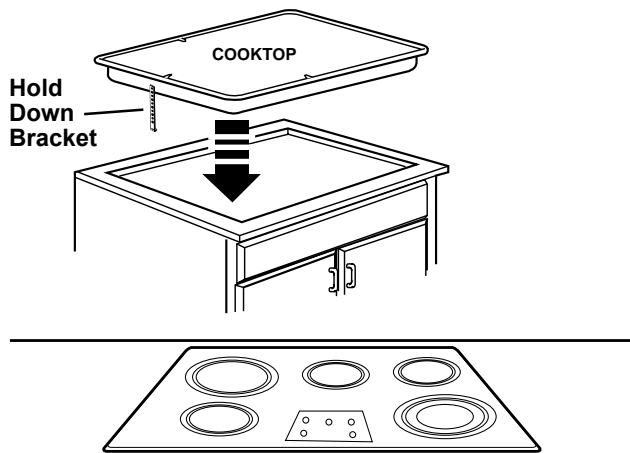

Attach Hold Down Brackets to Cabinet

- B7** Open the cabinet door and screw the Hold Down Brackets to the cabinet sides with the screws provided.

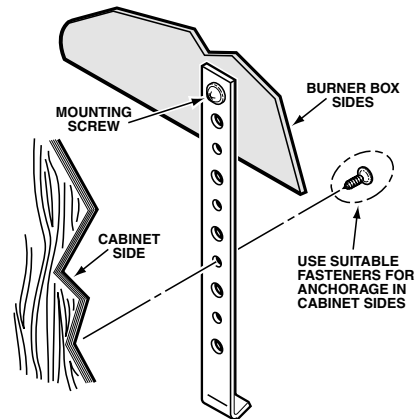

Installation Instructions

C Installation–Electrical Connections

C1 When making the wire connections, use the entire length of conduit provided. **The conduit must not be shortened.**

C2 With the cooktop in place open the front of the cabinet door.

C3 Insert the wires from the conduit through the opening of the junction box.

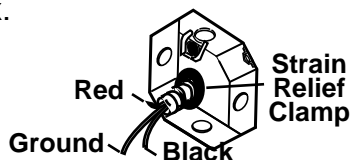

C4 Connect the red and black leads from the cooktop conduit to the corresponding leads in the junction box.

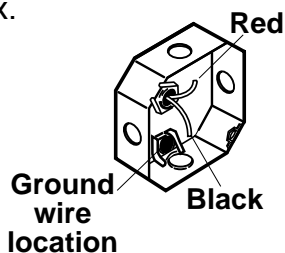

C5 Once the connections are made, secure wires together using wire nuts.

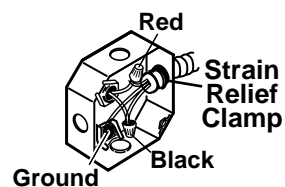

The bare ground wire in the conduit is connected to the cooktop frame. When connecting to a 3 conductor branch circuit, if local codes permit, connect the bare ground connector lead of the cooktop to the branch circuit neutral (gray or white in color).



IMPORTANT: If the cooktop is being installed into a blind counter (one with no cabinet opening below), wire connections must be made before putting the cooktop into the cutout opening.

SPECIAL GROUNDING INSTRUCTIONS

- When connecting to a 4-conductor branch circuit
- When local codes do not permit grounding through neutral
- When installing cooktop in a mobile home Attach the appliance grounding lead (green or bare copper) to the residence grounding conductor (green or bare copper) in accordance with local codes.

Installation Instructions



Pre-Test Checklist



Remove all protective film if present, and any stickers.



Check level of appliance.



Check to be sure that all wiring is secure and not pinched or in contact with moving parts.



Check that the cooktop is properly grounded.



Operation Checklist



Remove all items from the top of the cooktop surface.



Turn on the power to the cooktop. (Refer to your Use and Care Manual.) Verify all surface burners operate properly.



Check that the circuit breaker is not tripped or the house fuse is blown.



Check that conduit is securely connected to the junction box.



See Use & Care manual for troubleshooting list.



NOTE TO ELECTRICIAN:
The power leads supplied with this appliance are UL recognized for connections to larger gauge household wiring. The insulation of these leads is rated at temperatures much higher than the temperature rating of household wiring. The current carrying capacity of a conductor is governed by the wire gauge and also the temperature rating of the insulation around the wire.

NOTE: ALUMINUM WIRING

- A. **WARNING:**
IMPROPER CONNECTION OF ALUMINUM HOUSE WIRING TO THE COPPER LEADS CAN RESULT IN A SERIOUS PROBLEM.
- B. **Splice copper wires to aluminum wiring using special connectors designed and UL approved for joining copper to aluminum and follow the manufacturer's recommended connector procedure closely.**

NOTE: Wire used, location and enclosure of splices, etc., must conform to good wiring practice and local codes.