



Self-Cleaning Gas Ranges

Safety Instructions2-7

Operating Instructions

Aluminum Foil12
Clock and Timer14
Oven10-20
Baking and Roasting12
Broiling, Broiling Guide . .13
Oven Controls10
Power Outage11, 14
Preheating12
Self-Cleaning19, 20
Special Features16, 17
Thermostat Adjustment . .18
Timed Baking and Roasting15
Surface Cooking8, 9

Care and Cleaning

Broiler Pan and Grid24
Burner Assembly21, 22
Burner Grates23
Control Panel and Knobs . .25
Cooktop Surface23
Door Removal24
Oven Bottom24
Oven Light Replacement . .26
Oven Vents25
Self-Cleaning19, 20
Shelves25
Storage Drawer25

Installation

Instructions27-37
Air Adjustment36
Anti-Tip Device30, 37
Checking Burner Ignition . .35
Connecting the Range to Gas31-33
Dimensions and Clearances29
Electrical Connections . .34, 35
Leveling the Range36
Location30

Troubleshooting

Tips38-41

AccessoriesBack Cover

Owner's Manual & Installation Instructions

JGBP35GXA
220V, 50Hz

Write the model and serial numbers here:

Model # _____

Serial # _____

You can find them on a label on the front of the range behind the storage drawer.



IMPORTANT SAFETY INFORMATION. READ ALL INSTRUCTIONS BEFORE USING.

⚠️ WARNING!

For your safety, the information in this manual must be followed to minimize the risk of fire or explosion, electric shock, or to prevent property damage, personal injury, or loss of life.



⚠️ WARNING!

ANTI-TIP DEVICE

- ALL RANGES CAN TIP
- INJURY TO PERSONS COULD RESULT
- INSTALL ANTI-TIP DEVICES PACKED WITH RANGE
- SEE INSTALLATION INSTRUCTIONS

WARNING: If the information in this manual is not followed exactly, a fire or explosion may result, causing property damage, personal injury or death.

— Do not store or use gasoline or other flammable vapors and liquids in the vicinity of this or any other appliance.

— **WHAT TO DO IF YOU SMELL GAS**

- Do not try to light any appliance.
- Do not touch any electrical switch; do not use any phone in your building.
- Immediately call your gas supplier from a neighbor's phone. Follow the gas supplier's instructions.
- If you cannot reach your gas supplier, call the fire department.

— Installation and service must be performed by a qualified installer, service agency or the gas supplier.



ANTI-TIP DEVICE

All ranges can tip and injury could result.

To prevent accidental tipping of the range, attach it to the wall by installing the Anti-Tip device supplied.

If the Anti-Tip device supplied with the range does not fit this application, use the universal Anti-Tip device WB2X7909.

To check if the device is installed and engaged properly, carefully tip the range forward. The Anti-Tip device should engage and prevent the range from tipping over.

If you pull the range out from the wall for any reason, make sure the device is properly engaged when you push the range back against the wall. If it is not, there is a possible risk of the range tipping over and causing injury if you or a child stand, sit or lean on an open door.

Please refer to the Anti-Tip device information in this manual. Failure to take this precaution could result in tipping of the range and injury.

⚠ WARNING!



IMPORTANT SAFETY NOTICE

The California Safe Drinking Water and Toxic Enforcement Act requires the Governor of California to publish a list of substances known to the state to cause birth defects or other reproductive harm, and requires businesses to warn customers of potential exposure to such substances.

Gas appliances can cause minor exposure to four of these substances, namely benzene, carbon monoxide, formaldehyde and soot, caused primarily by the incomplete combustion of natural gas or LP fuels. Properly adjusted burners, indicated by a bluish rather than a yellow flame, will minimize incomplete combustion. Exposure to these substances can be minimized by venting with an open window or using a ventilation fan or hood.



SAFETY PRECAUTIONS

Have the installer show you the location of the range gas shut-off valve and how to shut it off if necessary.

- Have your range installed and properly grounded by a qualified installer, in accordance with the Installation Instructions. Any adjustment and service should be performed only by qualified gas range installers or service technicians.
- Do not attempt to repair or replace any part of your range unless it is specifically recommended in this manual. All other service should be referred to a qualified technician.
- Plug your range into a 220-volt grounded outlet only. If in doubt about the grounding of the home electrical system, it is your personal responsibility and obligation to have an ungrounded outlet replaced with a properly grounded outlet.

IMPORTANT SAFETY INFORMATION. READ ALL INSTRUCTIONS BEFORE USING.

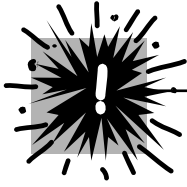

SAFETY PRECAUTIONS

- Locate the range out of kitchen traffic path and out of drafty locations to prevent poor air circulation.
- Be sure all packaging materials are removed from the range before operating it to prevent fire or smoke damage should the packaging material ignite.
- Be sure your range is correctly adjusted by a qualified service technician or installer.
- Never wear loose fitting or hanging garments while using the appliance. Be careful when reaching for items stored in cabinets over the range. Flammable material could be ignited if brought in contact with flame or hot oven surfaces and may cause severe burns.
- Do not store flammable materials in an oven, a range storage drawer, a warming drawer or near a cooktop.

WARNING: These adjustments must be made by a qualified service technician in accordance with the manufacturer's instructions and all codes and requirements of the authority having jurisdiction. Failure to follow these instructions could result in serious injury or property damage.

- After prolonged use of a range, high floor temperatures may result and many floor coverings will not withstand this kind of use. Never install the range over vinyl tile or linoleum that cannot withstand such type of use. Never install it directly over interior kitchen carpeting.
- Do not leave children alone or unattended where a range is hot or in operation. They could be seriously burned.
- Do not allow anyone to climb, stand or hang on the oven door, storage drawer, warming drawer or cooktop. They could damage the range and even tip it over, causing severe personal injury.
- **CAUTION:** Items of interest to children should not be stored in cabinets above a range or on the backsplash of a range—children climbing on the range to reach items could be seriously injured.
- For your safety, never use your appliance for warming or heating the room.
- Do not store or use combustible materials, gasoline or other flammable vapors and liquids in the vicinity of this or any other appliance.
- Do not let cooking grease or other flammable materials accumulate in or near the range.
- Do not use water on grease fires. Never pick up a flaming pan. Turn the controls off. Smother a flaming pan on a surface burner by covering the pan completely with a well-fitting lid, cookie sheet or flat tray. Use a multi-purpose dry chemical or foam-type fire extinguisher.

Flaming grease outside a pan can be put out by covering it with baking soda or, if available, by using a multi-purpose dry chemical or foam-type fire extinguisher.

Flame in the oven can be smothered completely by closing the oven door or drawer and turning the control to off or by using a multi-purpose dry chemical or foam-type fire extinguisher.

- Let the burner grates and other surfaces cool before touching them or leaving them where children can reach them.
- Never block the vents (air openings) of the range. They provide the air inlet and outlet that are necessary for the range to operate properly with correct combustion. Air openings are located at the rear of the cooktop, at the top and bottom of the oven door, and at the bottom of the range under the storage drawer.
- Large scratches or impacts to glass doors can lead to broken or shattered glass.

⚠ **WARNING!**



SURFACE BURNERS

Use proper pan size—avoid pans that are unstable or easily tipped. Select cookware having flat bottoms large enough to cover burner grates. To avoid spillovers, make sure cookware is large enough to contain the food properly. This will both save cleaning time and prevent hazardous accumulations of food, since heavy spattering or spillovers left on range can ignite. Use pans with handles that can be easily grasped and remain cool.

- Always use the **LITE** position when igniting the top burners and make sure the burners have ignited.
- Never leave the surface burners unattended at high flame settings. Boilovers cause smoking and greasy spillovers that may catch on fire.
- Adjust the top burner flame size so it does not extend beyond the edge of the cookware. Excessive flame is hazardous.
- Use only dry pot holders—moist or damp pot holders on hot surfaces may result in burns from steam. Do not let pot holders come near open flames when lifting cookware. Do not use a towel or other bulky cloth in place of a pot holder.
- When using glass cookware, make sure it is designed for top-of-range cooking.
- To minimize the possibility of burns, ignition of flammable materials and spillage, turn cookware handles toward the side or back of the range without extending over adjacent burners.
- Carefully watch foods being fried at a high flame setting.
- Always heat fat slowly, and watch as it heats.
- Do not leave any items on the cooktop. The hot air from the vent may ignite flammable items and will increase pressure in closed containers, which may cause them to burst.
- If a combination of oils or fats will be used in frying, stir together before heating or as fats melt slowly.
- Use a deep fat thermometer whenever possible to prevent overheating fat beyond the smoking point.
- Use the least possible amount of fat for effective shallow or deep-fat frying. Filling the pan too full of fat can cause spillovers when food is added.
- When flaming foods are under the hood, turn the fan off. The fan, if operating, may spread the flames.
- Do not use a wok on the cooking surface if the wok has a round metal ring that is placed over the burner grate to support the wok. This ring acts as a heat trap, which may damage the burner grate and burner head. Also, it may cause the burner to work improperly. This may cause a carbon monoxide level above that allowed by current standards, resulting in a health hazard.
- Foods for frying should be as dry as possible. Frost on frozen foods or moisture on fresh foods can cause hot fat to bubble up and over the sides of the pan.
- Never try to move a pan of hot fat, especially a deep fat fryer. Wait until the fat is cool.
- Do not leave plastic items on the cooktop—they may melt if left too close to the vent.
- Keep all plastics away from the surface burners.
- To avoid the possibility of a burn, always be certain that the controls for all burners are at the **OFF** position and all grates are cool before attempting to remove them.
- If range is located near a window, do not hang long curtains that could blow over the surface burners and create a fire hazard.
- If you smell gas, turn off the gas to the range and call a qualified service technician. Never use an open flame to locate a leak.
- Always turn the surface burner controls off before removing cookware.
- Do not lift the cooktop. Lifting the cooktop can lead to damage and improper operation of the range.

IMPORTANT SAFETY INFORMATION. READ ALL INSTRUCTIONS BEFORE USING.



COOK MEAT AND POULTRY THOROUGHLY...

Cook meat and poultry thoroughly—meat to at least an INTERNAL temperature of 160°F and poultry to at least an INTERNAL temperature of 180°F. Cooking to these temperatures usually protects against foodborne illness.



OVEN

Stand away from the range when opening the door of a hot oven. The hot air and steam that escape can cause burns to hands, face and eyes.

- Do not use the oven for a storage area. Items stored in the oven can ignite.
- Keep the oven free from grease buildup.
- Place the oven shelves in the desired position while the oven is cool.
- Pulling out the shelf to the stop-lock is a convenience in lifting heavy foods. It is also a precaution against burns from touching hot surfaces of the door or oven walls. The lowest position is not designed to slide.
- Do not heat unopened food containers. Pressure could build up and the container could burst, causing an injury.
- Never use aluminum foil to line the oven bottom. Improper use of foil could start a fire and result in high carbon monoxide.
- Do not use aluminum foil anywhere in the oven except as described in this manual. Misuse could result in a fire hazard or damage to the range.
- When using cooking or roasting bags in the oven, follow the manufacturer's directions.
- Do not use your oven to dry newspapers. If overheated, they can catch fire.
- Use only glass cookware that is recommended for use in gas ovens.
- Always remove the broiler pan from range as soon as you finish broiling. Grease left in the pan can catch fire if oven is used without removing the grease from the broiler pan.
- When broiling, if meat is too close to the flame, the fat may ignite. Trim excess fat to prevent excessive flare-ups.
- Make sure the broiler pan is in place correctly to reduce the possibility of grease fires.
- If you should have a grease fire in the broiler pan, press the **CLEAR/OFF** pad, and keep the oven door closed to contain fire until it burns out.
- For safety and proper cooking performance, always bake and broil with the oven door closed.



SELF-CLEANING OVEN

- Be sure to wipe off excess spillage before self-cleaning operation.
- Before self-cleaning the oven, remove the shelves, broiler pan, grid and other cookware.
- Do not clean the door gasket. The door gasket is essential for a good seal. Care should be taken not to rub, damage or move the gasket.
- Clean only parts listed in this Owner's Manual.
- If the self-cleaning mode malfunctions, turn the oven off and disconnect the power supply. Have it serviced by a qualified technician.
- Do not use oven cleaners. No commercial oven cleaner or oven liner of any kind should be used in or around any part of the oven. Residue from oven cleaners will damage the inside of the oven when the self-clean cycle is used.



READ AND FOLLOW THIS SAFETY INFORMATION CAREFULLY.

SAVE THESE INSTRUCTIONS

Using the gas surface burners.

Throughout this manual, features and appearance may vary from your model.

Before Lighting a Gas Burner

- Drip pans are supplied with your range; they should be used at all times.
- Make sure all burners are in place.
- Make sure all grates on the range are properly placed before using any burner.

After Lighting a Gas Burner

- Do not operate the burner for an extended period of time without cookware on the grate. The finish on the grate may chip without cookware to absorb the heat.
- Be sure the burners and grates are cool before you place your hand, a pot holder, cleaning cloths or other materials on them.

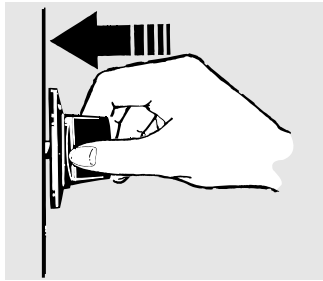

Push the control knob in and turn it to the **LITE** position.

How to Light a Gas Surface Burner

Make sure all the surface burners are placed in their respective positions.

Push the control knob in and turn it to the **LITE** position.

You will hear a little **clicking** noise—the sound of the electric spark igniting the burner.

Turn the knob to adjust the flame size. If the knob stays at **LITE**, it will continue to click.

When one burner is turned to **LITE**, all the burners spark. Do not attempt to disassemble or clean around any burner while another burner is on. An electric shock may result, which could cause you to knock over hot cookware.

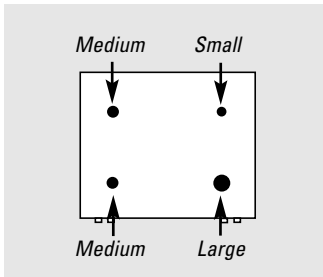

Sealed Gas Burners

Your gas range cooktop has four sealed gas burners. They offer convenience and flexibility to be used in a wide range of cooking applications.

The smallest burner in the right rear position is the simmer burner. This burner can be turned down to a very low simmer setting. It provides precise cooking performance for delicate foods such as sauces or foods that require low heat for a long cooking time.

The medium (left rear and left front) and the large (right front) burners are the primary burners for most cooking. These general-purpose burners can be turned down from **HI** to **LO** to suit a wide range of cooking needs.

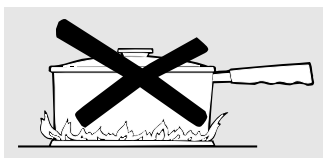

How to Select Flame Size

For safe handling of cookware, never let the flames extend up the sides of the cookware.

Watch the flame, not the knob, as you reduce heat. When fast heating is desired, the flame size on a gas burner should match the cookware you are using.

Flames larger than the bottom of the cookware will not result in faster heating of the cookware and could be hazardous.

Top-of-Range Cookware

Aluminum: Medium-weight cookware is recommended because it heats quickly and evenly. Most foods brown evenly in an aluminum skillet. Use saucepans with tight-fitting lids when cooking with minimum amounts of water.

Cast-Iron: If heated slowly, most skillets will give satisfactory results.

Enamelware: Under some conditions, the enamel of some cookware may melt. Follow cookware manufacturer's recommendations for cooking methods.

Glass: There are two types of glass cookware—those for oven use only and those for top-of-range cooking (saucepans, coffee and teapots). Glass conducts heat very slowly.

Heatproof Glass Ceramic: Can be used for either surface or oven cooking. It conducts heat very slowly and cools very slowly. Check cookware manufacturer's directions to be sure it can be used on gas ranges.

Stainless Steel: This metal alone has poor heating properties and is usually combined with copper, aluminum or other metals for improved heat distribution. Combination metal skillets usually work satisfactorily if they are used with medium heat as the manufacturer recommends.

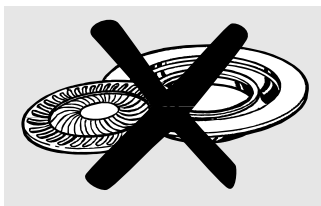

Stove Top Grills

Do not use stove top grills on your sealed gas burners. If you use the stove top grill on the sealed gas burner, it will cause incomplete combustion and can result in exposure to carbon monoxide levels above allowable current standards.

This can be hazardous to your health.

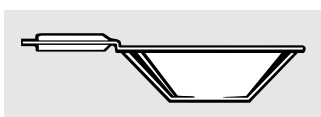

Use a flat-bottomed wok.

Wok This Way

We recommend that you use a 14" or smaller flat-bottomed wok. Make sure the wok bottom sits flat on the grate. They are available at your local retail store.

Only a flat-bottomed wok should be used.

Do not use a flat-bottomed wok on a support ring. Placing the ring over the burner or grate may cause the burner to work improperly, resulting in carbon monoxide levels above allowable standards. This could be dangerous to your health.

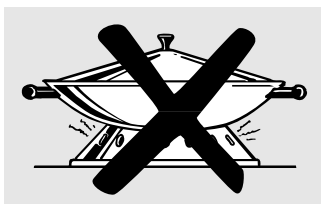

In Case of Power Failure

In case of a power failure, you can light the gas surface burners on your range with a match. Hold a lit match to the burner, then push in and turn the control knob to the **LITE** position. Use extreme caution when lighting burners this way.

Surface burners in use when an electrical power failure occurs will continue to operate normally.

Using the oven controls.

Throughout this manual, features and appearance may vary from your model.

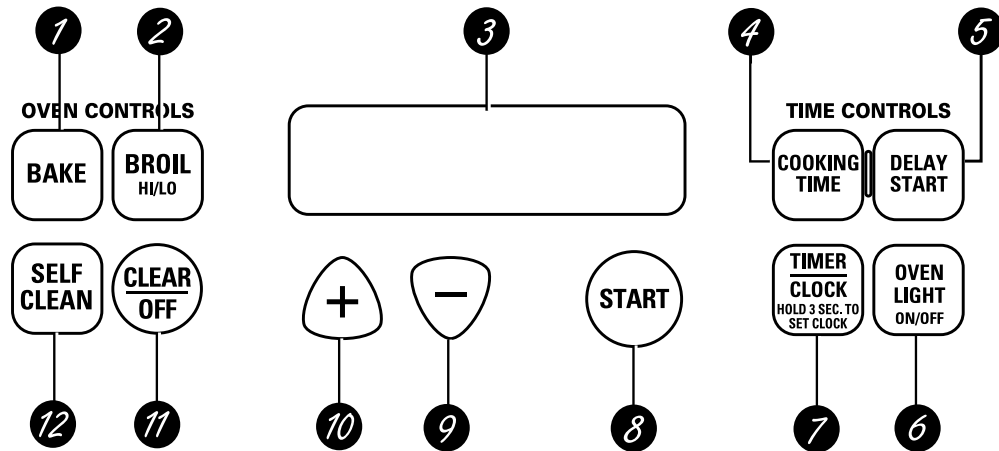

Oven Control, Clock and Timer Features and Settings

- 1 BAKE Pad**
Touch this pad to select the bake function.
- 2 BROIL HI/LO Pad**
Touch this pad to select the broil function.
- 3 Display**
Shows the time of day and the time set for the timer.
If "F— and a number or letter" flash in the display and the oven control signals, this indicates a function error code.
If your oven was set for a timed oven operation and a power outage occurred, the clock and all programmed functions must be reset.
The time of day will flash in the display when there has been a power outage.
- 4 COOKING TIME Pad**
Touch this pad and then touch the + or - pads to set the amount of time you want your food to cook. The oven will shut off when the cooking time has run out.
- 5 DELAY START Pad**
Touch this pad and the + or - pads to delay the starting of your oven up to 9 hours and 59 minutes.
- 6 OVEN LIGHT Pad**
Touch this pad to turn the oven light on or off.
- 7 TIMER/CLOCK Pad**
Touch this pad to select the timer feature. Touch and hold this pad, until the display changes, to set the clock.
- 8 START Pad**
Must be touched to start any cooking or cleaning function.
- 9 - Pad**
Short taps to this pad will decrease the time or temperature by small amounts. Touch and hold the pad to decrease the time or temperature by larger amounts.
- 10 + Pad**
Short taps to this pad will increase the time or temperature by small amounts. Touch and hold the pad to increase the time or temperature by larger amounts.
- 11 CLEAR/OFF Pad**
Touch this pad to cancel **ALL** oven operations except the clock and timer.
- 12 SELF CLEAN Pad**
Touch this pad to select the self-cleaning function. See the *Using the self-cleaning oven* section.

Using the oven.

To avoid possible burns, place the shelves in the desired position before you turn the oven on.

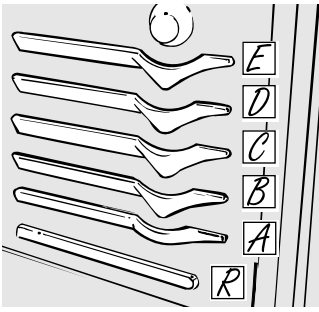

The oven has 5 shelf positions.

It also has a special low shelf position (R) for extra large items, such as a large turkey.

Before you begin...

The shelves have stop-locks, so that when placed correctly on the shelf supports (A through E), they will stop before coming completely out, and will not tilt.

When placing and removing cookware, pull the shelf out to the bump on the shelf support.

To remove a shelf, pull it toward you, tilt the front end up and pull it out.

To replace, place the end of the shelf (stop-locks) on the support, tilt up the front and push the shelf in.

NOTE: The shelf is not designed to slide out at the special low shelf (R) position.

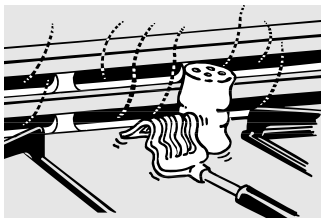

Plastic items on the cooktop may melt if left too close to the vent. Vent appearance and location vary.

Oven Vent

Your oven is vented through ducts at the rear of the range. Do not block these ducts when cooking in the oven—it is important that the flow of hot air from the oven and fresh air to the oven burner be uninterrupted. Avoid touching the vent openings or nearby surfaces during oven or broiler operation—they may become hot.

- Handles of pots and pans on the cooktop may become hot if left too close to the vent.
- Do not leave plastic or flammable items on the cooktop—they may melt or ignite if left too close to the vent.
- Do not leave closed containers on the cooktop. The pressure in closed containers may increase, which may cause them to burst.
- Metal items will become very hot if they are left on the cooktop, and could cause burns.

Power Outage

CAUTION: Do not make any attempt to operate the electric ignition oven during an electrical power failure.

The oven or broiler cannot be lit during a power failure. Gas will not flow unless the glow bar is hot.

If the oven is in use when a power failure occurs, the oven burner shuts off and cannot be re-lit until power is restored. This is because the flow of gas is automatically stopped and will not resume when power is restored until the glow bar has reached operating temperature.

Oven Light

Touch the **OVEN LIGHT** pad on the upper control panel to turn the light on or off.

Using the oven.

If your model has a door latch, do not lock the oven door with the latch during baking or roasting. The latch is used for self-cleaning only.

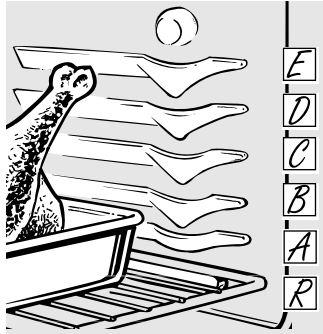

The oven has a special low shelf (R) position just above the oven bottom. Use it when extra cooking space is needed, for example, when cooking a large turkey. The shelf is not designed to slide out at this position.

How to Set the Oven for Baking or Roasting

Your oven is not designed for open-door cooking.

- 1 Touch the **BAKE** pad.
- 2 Touch the **+** or **-** pads until the desired temperature is displayed.
- 3 Touch the **START** pad.
- 4 Check food for doneness at minimum time on recipe. Cook longer if necessary.
- 5 Touch the **CLEAR/OFF** pad when cooking is complete.

Type of Food	Shelf Position
Frozen pies (on cookie sheet)	B or C
Angel food cake, bundt or pound cakes	B
Biscuits, muffins, brownies, cookies, cupcakes, layer cakes, pies	C
Casseroles	B or C
Roasting	R or A

Preheating and Pan Placement

Preheat the oven if the recipe calls for it. To preheat, set the oven at the correct temperature. Preheating is necessary for good results when baking cakes, cookies, pastry and breads.

For ovens without a preheat indicator light or tone, preheat 10 minutes.

Baking results will be better if baking pans are centered in the oven as much as possible. Pans should not touch each other or the walls of the oven. If you need to use two shelves, stagger the pans so one is not directly above the other, and leave approximately 1½" between pans, from the front, back and sides of the wall.

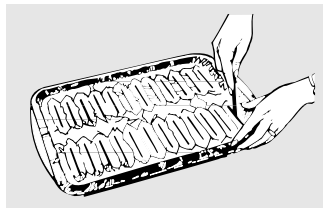

Cut slits in the foil just like the grid.

Aluminum Foil

Never cover the oven bottom with aluminum foil.

You can use aluminum foil to line the broiler pan and broiler grid. However, you must mold the foil tightly to the grid and cut slits in it just like the grid.

Aluminum foil may also be used to catch a spillover. To do so, place a small sheet of foil on a lower shelf several inches below the food.

Never entirely cover a shelf with aluminum foil. This will disturb the heat circulation and result in poor baking.

Oven Moisture

As your oven heats up, the temperature change of the air in the oven may cause water droplets to form on the door glass. These droplets are harmless and will evaporate as the oven continues to heat up.

If your model has a door latch, do not lock the oven door with the latch during broiling. The latch is used for self-cleaning only.

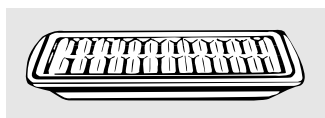

Always use the broiler pan and grid that came with your oven. It is designed to minimize smoking and spattering by trapping juices in the shielded lower part of the pan.

How to Set the Oven for Broiling

- 1 Place the meat or fish on the broiler grid in the broiler pan.
- 2 Follow suggested shelf positions in the *Broiling Guide*.
- 3 The oven door **must** be closed during broiling.
- 4 Touch the **BROIL HI/LO** pad once for **HI Broil**.
To change to **LO Broil**, touch the **BROIL HI/LO** pad again.
- 5 Touch the **START** pad.
- 6 When broiling is finished, touch the **CLEAR/OFF** pad.

Serve the food immediately, and leave the pan outside the oven to cool during the meal for easiest cleaning.

Use **LO Broil** to cook foods such as poultry or thick cuts of meat thoroughly without over-browning them.

Broiling Guide

Food	Quantity and/or Thickness	Shelf* Position	First Side Time (min.)	Second Side Time (min.)	Comments
Bacon	1/2 lb. (about 8 thin slices)	C	4	3	Arrange in single layer.
Ground Beef Well Done	1 lb. (4 patties) 1/2 to 3/4" thick	C	10	7-10	Space evenly. Up to 8 patties take about the same time.
Beef Steaks Rare† Medium Well Done	1" thick 1 to 1 1/2 lbs.	C C C	9 12 13	7 5-6 8-9	Steaks less than 1" thick cook through before browning. Pan frying is recommended. Slash fat.
Rare† Medium Well Done	1 1/2" thick 2 to 2 1/2 lbs.	C C C	10 12-15 25	6-7 10-12 16-18	
Chicken	1 whole 2 to 2 1/2 lbs., split lengthwise 4 bone-in breasts	B B	30-35 25-30	15-20 10-15	
Lobster Tails	2-4 6 to 8 oz. each	C	13-16	Do not turn over.	Cut through back of shell. Spread open. Brush with melted butter before broiling and after half of broiling time.
Fish Fillets	1/4 to 1/2" thick	D	6	6	Handle and turn very carefully. Brush with lemon butter before and during cooking, if desired. Preheat broiler to increase browning.
Ham Slices (precooked)	1" thick 1/2" thick	C D	8 6	8 6	
Pork Chops Well Done	2 (1/2" thick) 2 (1" thick) about 1 lb.	D D	10 15	8 8	Slash fat.
Lamb Chops Medium Well Done	2 (1" thick) about 10 to 12 oz.	D D	8 10	4-7 10	Slash fat.
Medium Well Done	2 (1 1/2" thick) about 1 lb.	D D	10 17	4-6 12-14	

The size, weight, thickness, starting temperature and your preference of doneness will affect broiling times. This guide is based on meats at refrigerator temperature.

†The U.S. Department of Agriculture says "Rare beef is popular, but you should know that cooking it to only 140°F means some food poisoning organisms may survive." (Source: *Safe Food Book, Your Kitchen Guide*, USDA Rev. June 1985.)

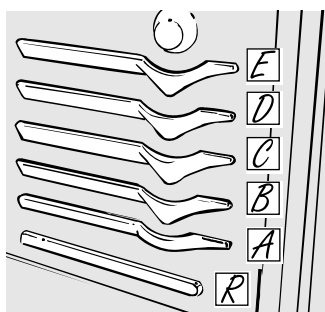

The oven has 5 shelf positions.

*See illustration for description of shelf positions.

Using the clock and timer.

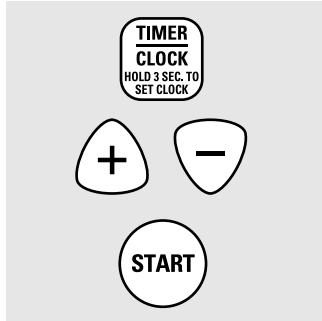

Make sure the clock is set to the correct time of day.

To Set the Clock

The clock must be set to the correct time of day for the automatic oven timing functions to work properly. The time of day cannot be changed during a timed baking or self-cleaning cycle. You cannot change the clock time while an automatic oven function is programmed.

- 1 Touch and hold the **TIMER/CLOCK** pad.
- 2 Touch the **+** and **-** pads.
- 3 Touch the **START** pad.

To check the time of day when the display is showing other information, simply touch the **TIMER/CLOCK** pad. The time of day shows until another pad is touched.

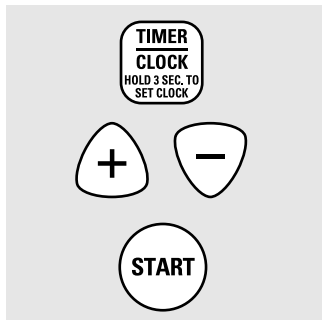

The timer is a minute timer only.

The timer does not control oven operations. The maximum setting on the timer is 9 hours and 59 minutes.

To Set the Timer

- 1 Touch the **TIMER/CLOCK** pad.
- 2 Touch the **+** and **-** pads until the amount of time you want shows in the display. Maximum time that can be entered in minutes is 59. Cooking times more than 59 minutes should be changed to hours and minutes. For example, enter 90 minutes as 1 hour, 30 minutes.

If you make a mistake, touch the **TIMER/CLOCK** pad and begin again.

- 3 Touch the **START** pad.
- 4 When the timer reaches **:00**, the control will beep 3 times followed by one beep every 6 seconds until the **TIMER/CLOCK** pad is touched.

The 6 second tone can be canceled by following the steps in the Special features of your oven control section under Tones at the End of a Timed Cycle.

To Reset the Timer

If the display is still showing the time remaining, you may change it by touching the **TIMER/CLOCK** pad, then touch the **+** and **-** pads until the time you want appears in the display.

If the remaining time is not in the display (clock, delay start or cooking time are in the display), recall the remaining time by touching the **TIMER/CLOCK** pad and then touching the **+** and **-** pads until the time you want appears in the display.

To Cancel the Timer

Touch the **TIMER/CLOCK** pad twice.

Power Outage

If a flashing time is in the display, you have experienced a power failure. Reset the clock.

To reset the clock, touch and hold the **TIMER/CLOCK** pad until the display changes.

Enter the correct time of day by touching the **+** and **-** pads until the time you want appears in the display. Touch the **START** pad.

Using the timed baking and roasting features.

NOTE: Foods that spoil easily—such as milk, eggs, fish, stuffings, poultry and pork—should not be allowed to sit for more than 1 hour before or after cooking. Room temperature promotes the growth of harmful bacteria. Be sure that the oven light is off because heat from the bulb will speed harmful bacteria growth.

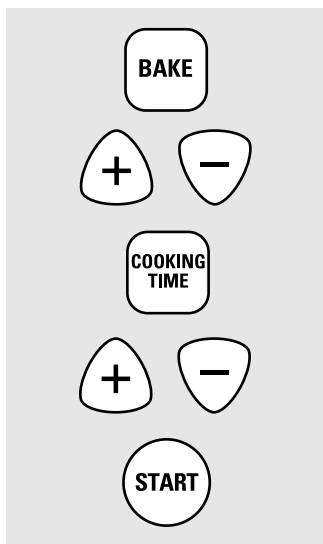

How to Set an Immediate Start and Automatic Stop

The oven will turn on immediately and cook for a selected length of time. At the end of the cooking time, the oven will turn off automatically.

- 1 Touch the **BAKE** pad.
- 2 Using the **+** and **-** pads, enter the desired temperature.
- 3 Touch the **COOKING TIME** pad.

NOTE: If your recipe requires preheating, you may need to add additional time to the length of the cooking time.

- 4 Using the **+** and **-** pads, enter the desired baking time. Maximum time that can be entered in minutes is 59. Cooking times more than 59 minutes should be changed to hours and minutes. For example, enter 90 minutes as 1 hour, 30 minutes. The oven temperature and the cooking time that you entered will be displayed.

- 5 Touch the **START** pad.

The display shows the current oven temperature and the cooking time countdown.

The oven will continue to cook for the programmed amount of time, then shut off automatically.

Touch the **CLEAR/OFF** pad to clear the display.

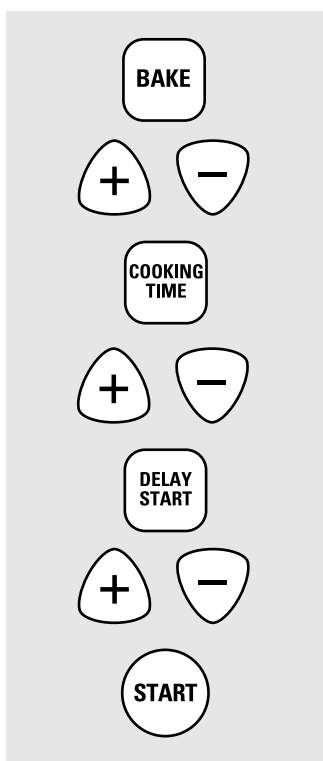

How to Set a Delayed Start and Automatic Stop

You can set the oven control to delay-start the oven, cook for a specific length of time and then turn off automatically.

Make sure the clock shows the correct time of day.

- 1 Touch the **BAKE** pad.
- 2 Using the **+** and **-** pads, enter the desired temperature.
- 3 Touch the **COOKING TIME** pad.

NOTE: If your recipe requires preheating, you may need to add additional time to the length of the cooking time.

- 4 Using the **+** and **-** pads, enter the desired baking time. Maximum time that can be entered in minutes is 59. Cooking times more than 59 minutes should be changed to hours and minutes. For example, enter 90 minutes as 1 hour, 30 minutes. The oven temperature and the cooking time that you entered will be displayed.

- 5 Touch the **DELAY START** pad.

- 6 Using the **+** and **-** pads, enter the time of day you want the oven to turn on and start cooking.

- 7 Touch the **START** pad.

NOTE: An attention tone will sound if you are using timed baking and do not touch the **START** pad after entering the baking temperature.

If you would like to check the times you have set, touch the **DELAY START** pad to check the start time you have set or touch the **COOKING TIME** pad to check the length of cooking time you have set.

When the oven turns on at the time of day you have set, the display will show the changing temperature (starting at 100°F) and the cooking time countdown.

At the end of timed baking, the oven will turn off. The end of cycle tone will sound.

Touch the **CLEAR/OFF** pad to clear the display.

Special features of your oven control.

Your new touch pad control has additional features that you may choose to use. The following are the features and how you may activate them.

The special feature modes can only be activated while the display is showing the time of day. They remain in the control's memory until the steps are repeated.

When the display shows your choice, touch the **START** pad. The special features will remain in memory after a power failure.

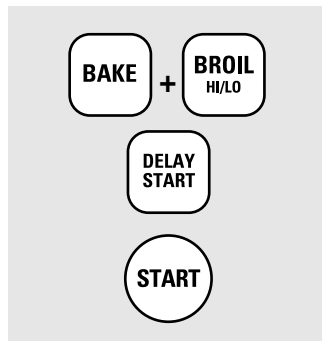

12 Hour Shut-Off

With this feature, should you forget and leave the oven on, the control will automatically turn off the oven after 12 hours during baking functions or after 3 hours during a broil function.

If you wish to turn **OFF** this feature, follow the steps below.

- 1 Touch the **BAKE** and **BROIL HI/LO** pads at the same time for 3 seconds until the display shows **SF**.

- 2 Touch the **DELAY START** pad. The display will show **12 shdn** (12 hour shut-off). Touch the **DELAY START** pad again and the display will show **no shdn** (no shut-off).

- 3 Touch the **START** pad to activate the no shut-off and leave the control set in this special features mode.

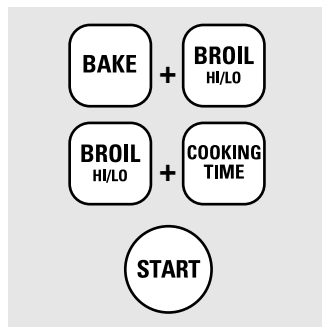

Fahrenheit or Celsius Temperature Selection

Your oven control is set to use the Fahrenheit temperature selections, but you may change this to use the Celsius selections.

- 1 Touch the **BAKE** and **BROIL HI/LO** pads at the same time for 3 seconds until the display shows **SF**.

- 2 Touch the **BROIL HI/LO** and **COOKING TIME** pads at the same time. The display will show **F** (Fahrenheit).

- 3 Touch the **BROIL HI/LO** and **COOKING TIME** pads at the same time again. The display will show **C** (Celsius).

- 4 Touch the **START** pad.

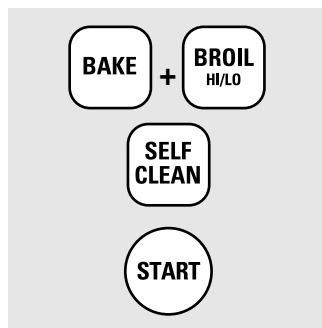

Oven Lockout (on some models)

Your control will allow you to lock out the touch pads so they cannot be activated when touched.

- 1 Touch the **BAKE** and **BROIL HI/LO** pads at the same time for 3 seconds until the display shows **SF**.

- 2 Touch the **SELF CLEAN** pad. The display will show **LOC OFF**.

Touch the **SELF CLEAN** pad again. The display will show **LOC ON**.

- 3 Touch the **START** pad to activate the oven lockout feature and leave the control set in this special features mode.

When this feature is on and the touch pads are touched, the control will beep and the display will show **LOC**.

NOTE: The oven lockout mode will not affect the **TIMER/CLOCK** touch pad.

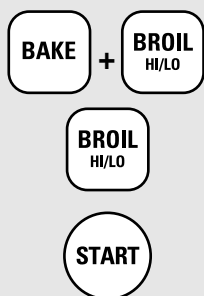

Tones at the End of a Timed Cycle

At the end of a timed cycle, 3 short beeps will sound followed by one beep every 6 seconds until the CLEAR/OFF pad is touched. This continual 6 second beep may be canceled.

To cancel the 6 second beep:

- 1 Touch the **BAKE** and **BROIL HI/LO** pads at the same time for 3 seconds until the display shows **SF**.

- 2 Touch the **BROIL HI/LO** pad. The display shows **CON BEEP** (continual beep). Touch the **BROIL HI/LO** pad again. The display shows **BEEP**. (This cancels the one beep every 6 seconds.)

- 3 Touch the **START** pad.

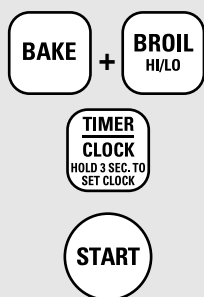

12 Hour, 24 Hour or Clock Black-Out

Your control is set to use a 12 hour clock.

If you would prefer to have a 24 hour military time clock or black-out the clock display, follow the steps below.

- 1 Touch the **BAKE** and **BROIL HI/LO** pads at the same time for 3 seconds until the display shows **SF**.

- 2 Touch the **TIMER/CLOCK** pad once. The display will show **12 hr**. If this is the choice you want, touch the **START** pad.

Touch the **TIMER/CLOCK** pad again to change to the 24 hour military time clock. The display will show **24 hr**. If this is the choice you want, touch the **START** pad.

Touch the **TIMER/CLOCK** pad again to black-out the clock display. The display will show **OFF**. If this is the choice you want, touch the **START** pad.

NOTE: If the clock is in the black-out mode, you will not be able to use the Delay Start function.

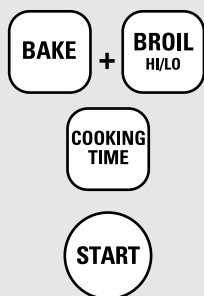

Cook and Hold

Your new control has a cook and hold feature that keeps cooked foods warm for up to 3 hours after the cooking function is finished.

To activate this feature, follow the steps below.

- 1 Touch the **BAKE** and **BROIL HI/LO** pads at the same time for 3 seconds until the display shows **SF**.

- 2 Touch the **COOKING TIME** pad. The display will show **Hid OFF**.

Touch the **COOKING TIME** pad again to activate the feature. The display will show **Hid ON**.

- 3 Touch the **START** pad to activate the cook and hold feature and leave the control set in this special features mode.

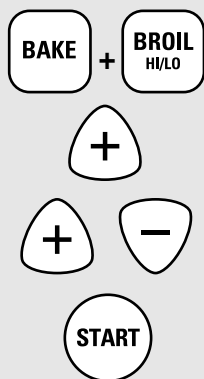

Changing the Speed of the Increase or Decrease Pads

As you use the **INCREASE** or **DECREASE** pads when setting a time or temperature, you may notice the display changes slowly. This special feature allows you to change the speed.

To set the speed you prefer, follow the steps below.

- 1 Touch the **BAKE** and **BROIL HI/LO** pads at the same time for 3 seconds until the display shows **SF**.

- 2 Touch the **+** pad. The display will show you a set speed between 1 and 5.

- 3 Touch the **+** pad to increase the speed up to the number 5.

Touch the **-** pad to decrease the speed down to the number 1.

- 4 Touch **START** to activate the setting and leave the control set in this special features mode.

Adjust the oven thermostat—Do it yourself!

You may find that your new oven cooks differently than the one it replaced. Use your new oven for a few weeks to become more familiar with it. If you still think your new oven is too hot or too cold, you can adjust the thermostat yourself.

Do not use thermometers, such as those found in grocery stores, to check the temperature setting of your oven. These thermometers may vary 20–40 degrees.

NOTE: This adjustment will not affect the broiling or the self-cleaning temperatures. The adjustment will be retained in memory after a power failure.

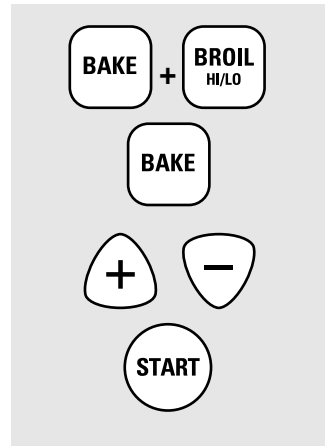

To Adjust the Thermostat

- 1 Touch the **BAKE** and **BROIL HI/LO** pads at the same time for 3 seconds until the display shows **SF**.
- 2 Touch the **BAKE** pad. A two digit number shows in the display.
- 3 The oven temperature can be adjusted up as much as 35°F or down as much as 35°F. Touch the **+** pad to increase the temperature by 1 degree increments. Touch the **-** pad to decrease the temperature by 1 degree increments.
- 4 When you have made the adjustment, touch the **START** pad to go back to the time of day display. Use your oven as you would normally.

The type of margarine will affect baking performance!

Most recipes for baking have been developed using high fat products such as butter or margarine (80% fat). If you decrease the fat, the recipe may not give the same results as with a higher fat product.

Recipe failure can result if cakes, pies, pastries, cookies or candies are made with low fat spreads. The lower the fat content of a spread product, the more noticeable these differences become.

Federal standards require products labeled “margarine” to contain at least 80% fat by weight. Low fat spreads, on the other hand, contain less fat and more water. The high moisture content of these spreads affects the texture and flavor of baked goods. For best results with your old favorite recipes, use margarine, butter or stick spreads containing at least 70% vegetable oil.

Using the self-cleaning oven.

If your model has a door latch, never force the latch handle. Forcing the handle will damage the door lock mechanism. The oven door must be closed and all controls set correctly for the cycle to work properly.

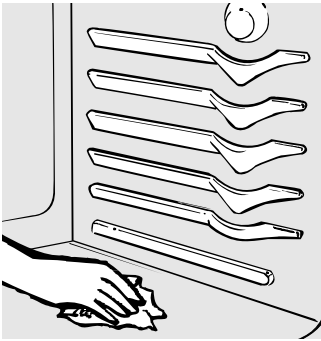

Wipe up heavy soil on the oven bottom.

Before a Clean Cycle

For the first self-clean cycle, we recommend venting your kitchen with an open window or using a ventilation fan or hood.

Remove the shelves, broiler pan, broiler grid, all cookware and any aluminum foil from the oven.

The oven shelves can be self-cleaned, but they will darken, lose their luster and become hard to slide.

Soil on the front frame of the range and outside the gasket on the door will need to be cleaned by hand. Clean these areas with hot water, soap-filled scouring pads or cleansers such as Soft Scrub®.

Rinse well with clean water and dry.

Do not clean the gasket. The fiberglass material of the oven door gasket cannot withstand abrasion. It is essential for the gasket to remain intact. If you notice it becoming worn or frayed, replace it.

Wipe up any heavy spillovers on the oven bottom.

Make sure the oven light bulb cover is in place and the oven light is off.

IMPORTANT: The health of some birds is extremely sensitive to the fumes given off during the self-cleaning cycle of any range. Move birds to another well ventilated room.

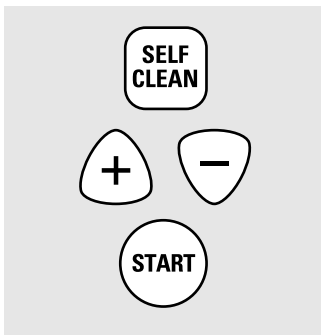

How to Set the Oven for Cleaning

- 1 Touch the **SELF CLEAN** pad.
- 2 Using the **+** or **-** pads, enter the desired clean time, if a time other than 4 hours and 20 minutes is needed.

Clean cycle time is normally 4 hours and 20 minutes. You can change the clean time to any time between 3 hours and 5 hours, depending on how dirty your oven is.

- 3 Touch the **START** pad.

The door locks automatically. The display will show the clean time remaining. It will not be possible to open the oven door until the temperature drops below the lock temperature and the **LOCKED** door light goes off.

When the **LOCKED** door light is off, open the door.

The oven shuts off automatically when the clean cycle is complete.

■ The words **LOCKED** or **LOCK DOOR** will flash and the oven control will signal if you set the clean cycle and forget to close the oven door.

■ To stop a clean cycle, touch the **CLEAR/OFF** pad. When the **LOCKED** door light goes off indicating the oven has cooled below the locking temperature, open the door.

Using the self-cleaning oven.

The oven door must be closed and all controls set correctly for the cycle to work properly.

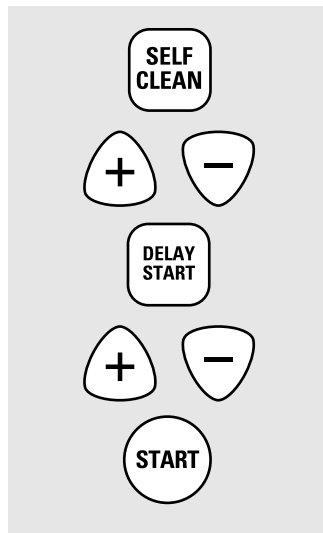

How to Delay the Start of Cleaning

Make sure the clock shows the correct time of day.

- 1 Touch the **SELF CLEAN** pad.
- 2 Using the **+** or **-** pads, enter the desired clean time.
- 3 Touch the **DELAY START** pad. The earliest start time you can set will appear in the display.
- 4 Using the **+** or **-** pads, enter the time of day you want the clean cycle to start.
- 5 Touch the **START** pad.

The door locks automatically. The display will show the start time. It will not be possible to open the oven door until the temperature drops below the lock temperature and the **LOCKED** door light goes off.

When the **LOCKED** door light is off, open the door.

After a Clean Cycle

You may notice some white ash in the oven. Wipe it up with a damp cloth after the oven cools.

If white spots remain, remove them with a soap-filled scouring pad and rinse thoroughly with a vinegar and water mixture.

These deposits are usually a salt residue that cannot be removed by the clean cycle.

If the oven is not clean after one clean cycle, repeat the cycle.

■ You cannot set the oven for cooking until the oven is cool enough for the door to unlock.

■ While the oven is self-cleaning, you can touch the **TIMER/CLOCK** pad to display the time of day. To return to the clean countdown, touch the **COOKING TIME** pad.

■ If the shelves become hard to slide, apply a small amount of vegetable oil or cooking oil to a paper towel and wipe the edges of the oven shelves with the paper towel.

Care and cleaning of the range.

Be sure electrical power is off and all surfaces are cool before cleaning any part of the range.

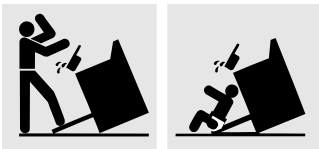

If your range is removed for cleaning, servicing or any reason, be sure the anti-tip device is re-engaged properly when the range is replaced. Failure to take this precaution could result in tipping of the range and cause injury.

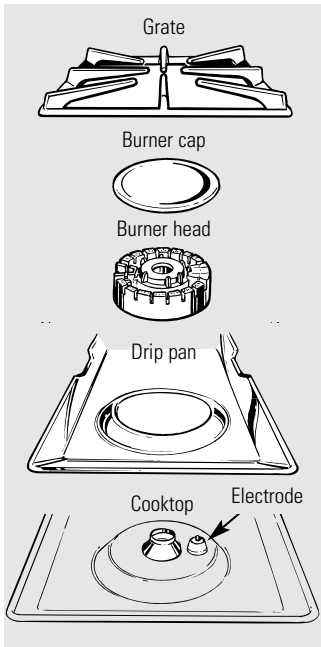

Sealed Burner Assemblies

Turn all controls **OFF** before removing the burner parts and drip pans.

The burner grates, caps, burner heads and drip pans can be lifted off, making them easy to clean.

CAUTION: Do not operate the cooktop without all burner parts, drip pans and grates in place.

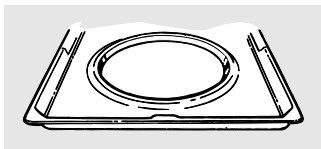
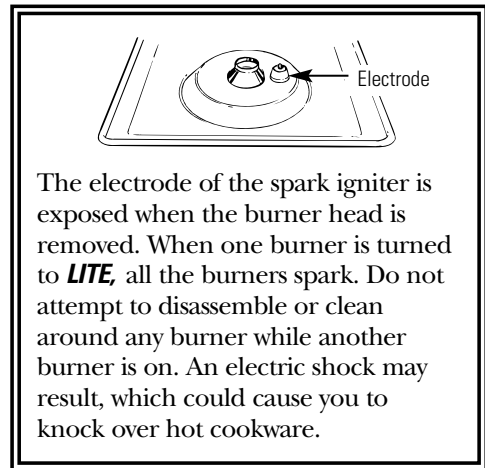

Drip Pans

Remove the grates and lift out the drip pans. Drip pans can be cleaned in a dishwasher or by hand.

When replacing the drip pans, make sure they are in the correct position.

To get rid of burned-on food, place them in a covered container (or plastic bag) with 1/4 cup ammonia to loosen the soil. Then scrub with a soap-filled scouring pad if necessary.

CAUTION: Do not clean the drip pans in a self-cleaning oven.

Care and cleaning of the range.

Burner Caps and Heads

NOTE: Before removing the burner caps and heads, remember their size and location. Replace them in the same location after cleaning.

Burner caps

Lift off when cool. Wash burner caps in hot, soapy water and rinse with clean water. You may scour with a plastic scouring pad to remove burned-on food particles.

Burner heads

For proper ignition, make sure the small hole in the section that fits over the electrode is kept open. A sewing needle or wire twist-tie works well to unclog it.

The slits in the burner heads must be kept clean at all times for an even, unhampered flame.

Clogged or dirty burner ports or electrodes will not allow the burner to operate properly.

Any spill on or around an electrode must be carefully cleaned. Take care to not hit an electrode with anything hard or it could be damaged.

You should clean the burner caps and burner heads routinely, especially after bad spillovers, which could clog the openings in the burner heads. Lift off when cool.

To remove burned-on food, soak the burner heads in a solution of mild liquid detergent and hot water for 20–30 minutes. For more stubborn stains, use a toothbrush.

After cleaning

Before putting the burner caps and heads back, shake out excess water and then dry them thoroughly by setting in a warm oven for 30 minutes.

NOTE: Do not use steel wool or scouring powders to clean the burners.

Replacement

Replace burner heads over the electrodes on the cooktop, in the correct locations according to their size.

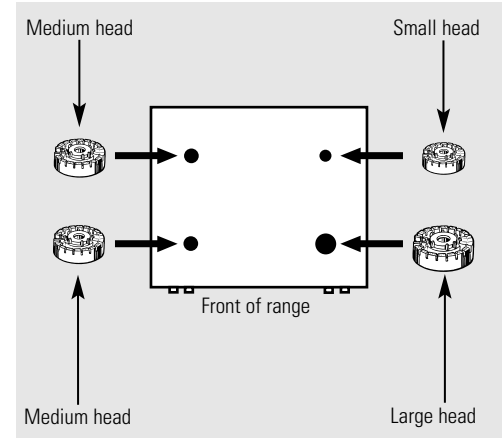

Make sure the slot in the burner head is positioned over the electrode.

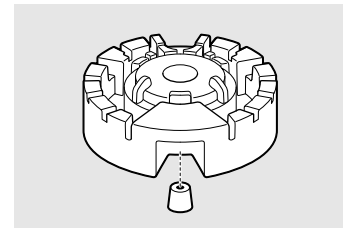

Replace the matching size caps onto the heads. There is one large, one small and two medium caps.

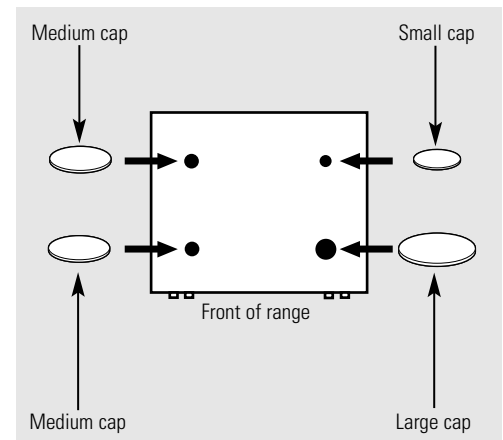

Make sure that the heads and caps are replaced in the correct locations.

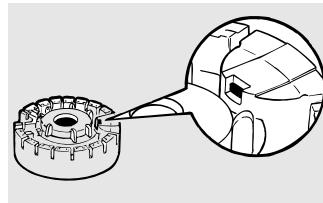

Use a sewing needle or twist-tie to unclog the small hole in the burner head.



Burner Grates

Lift out when cool. Grates should be washed regularly and, of course, after spillovers. Wash them in hot, soapy water and rinse with clean water. When replacing the grates, be sure they are positioned securely over the burners.

Do not operate a burner for an extended period of time without cookware on the grate. The finish on the grate may chip without cookware to absorb the heat.

To get rid of burned-on food, place the grates in a covered container. Add 1/4 cup ammonia and let them soak several hours or overnight. Wash, rinse well and dry.

Although they are durable, the grates will gradually lose their shine, regardless of the best care you can give them. This is due to their continual exposure to high temperatures. You will notice this sooner with lighter color grates.

NOTE: Do not clean the grates in a self-cleaning oven.

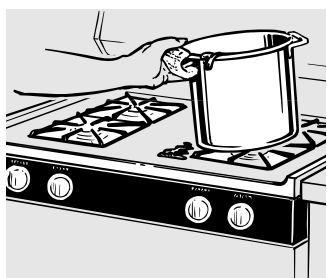

Cooktop Surface

To avoid damaging the porcelain enamel surface of the cooktop and to prevent it from becoming dull, clean up spills right away. Foods with a lot of acid (tomatoes, sauerkraut, fruit juices, etc.) or foods with high sugar content could cause a dull spot if allowed to set.

When the surface has cooled, wash and rinse. For other spills such as fat splatterings, etc., wash with soap and water once the surface has cooled. Then rinse and polish with a dry cloth.

NOTE: Do not store flammable materials in an oven or near the cooktop. Do not store or use combustible materials, gasoline or other flammable vapors and liquids in the vicinity of this or any other appliance.

NOTE: Do not lift the cooktop. Lifting the cooktop can lead to damage and improper operation of the range.

Care and cleaning of the range.

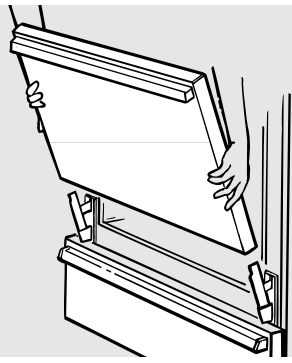

Lift the door straight up and off the hinges.

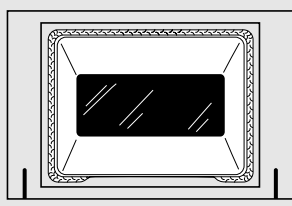

The gasket is designed with a gap at the bottom to allow for proper air circulation.

Do not rub or clean the door gasket—it has an extremely low resistance to abrasion.

If you notice the gasket becoming worn, frayed or damaged in any way or if it has become displaced on the door, you should have it replaced.

Lift-Off Oven Door

The oven door is removable, but it is heavy. You may need help removing and replacing the door.

To remove the door, open it a few inches to the special stop position that will hold the door open. Grasp firmly on each side and lift the door straight up and off the hinges.

NOTE: Be careful not to place hands between the hinge and the oven door frame as the hinge could snap back and pinch fingers.

To replace the door, make sure the hinges are in the special stop position. Position the slots in the bottom of the door squarely over the hinges. Then lower the door slowly and evenly over both hinges at the same time. If the hinges snap back against the oven frame, pull them back out.

To clean the inside of the door:

- Do not allow excess water to run into any holes or slots in the door.
- Because the area inside the gasket is cleaned during the self clean cycle, you do not need to clean this by hand. Any soap left on the liner causes additional stains when the oven is heated.

- The area outside the gasket can be cleaned with a soap-filled scouring pad.

To clean the outside of the door:

- Use soap and water to thoroughly clean the top, sides and front of the oven door. Rinse well. You may also use a glass cleaner to clean the glass on the outside of the door.
- Spillage of marinades, fruit juices, tomato sauces and basting materials containing acids may cause discoloration and should be wiped up immediately. When the surface is cool, clean and rinse.
- Do not use oven cleaners, cleansing powders or harsh abrasives on the outside of the door.

Oven Bottom

The oven bottom has a porcelain enamel finish. To make cleaning easier, protect the oven bottom from excessive spillovers by placing a cookie sheet on the shelf below the shelf you are cooking on. This is particularly important when baking a fruit pie or other foods with a high acid content. Hot fruit fillings or other foods that are highly acidic (such as tomatoes, sauerkraut, and sauces with vinegar or lemon juice) may cause pitting and damage to the porcelain enamel surface and should be wiped up immediately.

We don't recommend using aluminum foil on the oven bottom. It can affect air flow if the holes are blocked and it can concentrate heat at the bottom of the oven, resulting in poor baking performance.

To clean up spillovers, use soap and water, an abrasive cleaner or soap-filled scouring pad. Rinse well to remove any soap before self-cleaning.

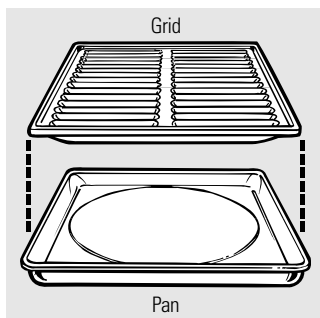

Broiler Pan and Grid

After broiling, remove the broiler pan from the oven. Remove the grid from the pan. Carefully pour out grease from the pan into a proper container. Wash and rinse the broiler pan and grid in hot water with a soap-filled or plastic scouring pad.

If food has burned on, sprinkle the grid with detergent while hot and cover with wet paper towels or a dishcloth. Soaking the pan will remove burned-on foods.

The broiler pan and grid may be cleaned with a commercial oven cleaner.

Both the broiler pan and grid can also be cleaned in a dishwasher.

Do not store a soiled broiler pan and grid anywhere in the range.

▲ CAUTION: Do not clean the broiler pan or grid in a self-cleaning oven.

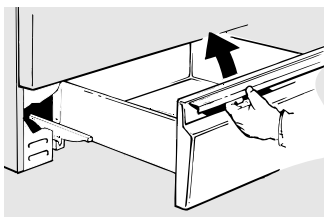

The storage drawer may be removed for cleaning under the range.

Removable Storage Drawer

The storage drawer is a good place to store cookware and bakeware. Do not store plastics and flammable material in the drawer.

The storage drawer may be removed for cleaning under the range. Clean the storage drawer with a damp cloth or sponge. Never use harsh abrasives or scouring pads.

To remove storage drawer:

- 1 Pull drawer straight out until it stops.
- 2 Tilt the front of the drawer up and free of the range.

To replace storage drawer:

- 1 Set the stops on the back of the drawer over the stops in the range.
- 2 Slide drawer evenly and straight back, so that the rails in the range are engaged.

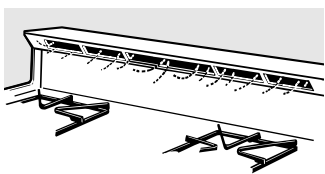

Vent appearance and location vary.

Oven Air Vents

Never block the vents (air openings) of the range. They provide the air inlet and outlet that are necessary for the range to operate properly with correct combustion.

Air openings are located at the rear of the cooktop, at the top and bottom of the oven door and at the bottom of the range, under the storage drawer.

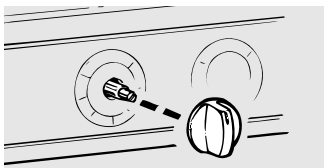

Pull the knob straight off the stem.

Lower Control Panel (Front Manifold Panel) and Knobs

It's a good idea to wipe the control panel after each use of the oven. Use a damp cloth to clean or rinse. For cleaning, use mild soap and water or a 50/50 solution of vinegar and water. For rinsing, use clean water. Polish dry with a soft cloth.

Do not use abrasive cleansers, strong liquid cleaners, plastic scouring pads or oven cleaners on the control panel—they will damage the finish.

Do not bend knobs by pulling them up or down or by hanging a towel or other such loads. This can damage the gas valve shaft.

The control knobs may be removed for easier cleaning. To remove a knob, pull it straight off the stem. If knob is difficult to remove, place a towel or dishcloth between the knob and control panel and pull gently. Wash the knobs in soap and water or a vinegar and hot water solution.

Metal parts can be cleaned with soap and water. Do not use steel wool, abrasives, ammonia, acids or commercial oven cleaners. Dry with a soft cloth.

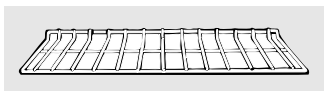

Oven Shelves

Clean the shelves with an abrasive cleanser or scouring pad. After cleaning, rinse the shelves with clean water and dry with a clean cloth.

If the shelves ever become hard to slide, wipe the shelf edges or oven shelf supports with vegetable oil.

NOTE: Take the shelves out of the oven before you begin the self-clean cycle or they may discolor.

Care and cleaning of the range.

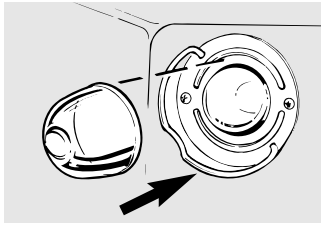

Wire cover holder.

Oven Light Replacement

⚠ CAUTION: Before replacing your oven light bulb, disconnect the electrical power to the range at the main fuse or circuit breaker panel. Be sure to let the light cover and bulb cool completely.

The oven light bulb is covered with a removable glass cover that is held in place with a bail-shaped wire. Remove the oven door, if desired, to reach cover easily.

To remove:

- 1 Hold a hand under the cover so it doesn't fall when released. With fingers of the same hand, firmly push back the wire cover holder. Lift off the cover.

Do not remove any screws to remove the cover.

- 2 Do not touch hot bulb with a wet cloth. Replace bulb with a 40-watt household appliance bulb.

To replace cover:

- 1 Place it into the groove of the light receptacle. Pull the wire forward to the center of the cover until it snaps into place. When in place, the wire holds the cover firmly. Be certain the wire is in the depression in the center of the cover.
- 2 Connect electrical power to the range.

BEFORE YOU BEGIN

Read these instructions completely and carefully.

Installation of this range must conform with local codes, or in the absence of local codes, with the National Fuel Gas Code, ANSI Z223.1/NFPA.54, latest edition. In Canada, installation must conform with the current Natural Gas Installation Code, CAN/CGA-B149.1 or the current Propane Installation Code, CAN/CGA-B149.2, and with local codes where applicable. This range has been design-certified by CSA International according to ANSI Z21.1, latest edition and Canadian Gas Association according to CAN/CGA-1.1 latest edition.

As with any appliance using gas and generating heat, there are certain safety precautions you should follow. You will find these precautions in the *Important Safety Information* section in the front of this manual. Read them carefully.

- **IMPORTANT** — Save these instructions for local electrical inspector's use.
- **IMPORTANT** — Observe all governing codes and ordinances.
- **Note to Installer** — Be sure to leave these instructions with the Consumer.
- **Note to Consumer** — Keep these instructions for future reference.
- **Note** — This appliance must be properly grounded.
- **Service** — The electrical diagram is in an envelope attached to the back of the range.
- **Skill level** — Installation of this appliance requires basic mechanical skills.
- Proper installation is the responsibility of the installer.

PART INCLUDED

Anti-Tip bracket kit

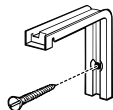

FOR YOUR SAFETY

Do not store or use combustible materials, gasoline or other flammable vapors and liquids in the vicinity of this or any other appliance.

If you smell gas:

- 1 Open windows.
- 2 Don't touch electrical switches.
- 3 Extinguish any open flame.
- 4 Immediately call your gas supplier.

TOOLS YOU WILL NEED

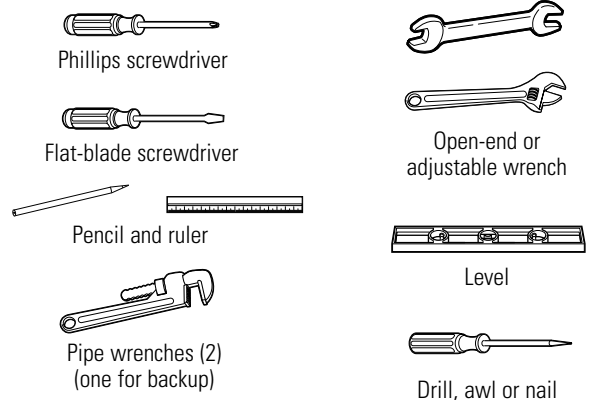

MATERIALS YOU MAY NEED

- Gas line shut-off valve
- Pipe joint sealant or UL-approved pipe thread tape with Teflon* that resists action of LP gases
- Flexible metal appliance connector (1/2" I.D.)
A 5-foot length is recommended for ease of installation but other lengths are acceptable. Never use an old connector when installing a new range.
- Flare union adapter for connection to gas supply line (3/4" or 1/2" NPT x 1/2" I.D.)
- Flare union adapter for connection to pressure regulator on range (1/2" NPT x 1/2" I.D.)
- Liquid leak detector or soapy water.
- Lag bolt or 1/2" O.D. sleeve anchor (for concrete floors only).

*Teflon: Registered trademark of DuPont

Installation Instructions

⚠ WARNING! **INSTALLATION SAFETY** **INSTRUCTIONS**

Read these instructions completely and carefully.

Improper installation, adjustment, alteration, service or maintenance can cause injury or property damage. Refer to this manual. For assistance or additional information, consult a qualified installer, service agency, manufacturer (dealer) or the gas supplier.

Never reuse old flexible connectors. The use of old flexible connectors can cause gas leaks and personal injury. Always use **NEW** flexible connectors when installing a gas appliance.

IMPORTANT — Remove all packing material and literature from oven before connecting gas and electrical supply to range.

CAUTION — Do not attempt to operate the oven of this range during a power failure (Electric Ignition models only).

- Have your range installed by a qualified installer.
- Your range must be electrically grounded in accordance with local codes or, in the absence of local codes, in accordance with the National Electrical Code (ANSI/NFPA 70, latest edition). In Canada, electrical grounding must be in accordance with the current CSA C22.1 Canadian Electrical Code Part 1 and/or local codes. See *Electrical Connections* in this section.
- Before installing your range on linoleum or any other synthetic floor covering, make sure the floor covering can withstand 180°F without shrinking, warping or discoloring. Do not install the range over carpeting unless a sheet of 1/4" thick plywood or similar insulator is placed between the range and carpeting.
- Make sure the wall coverings around the range can withstand heat generated by the range up to 200°F.

- Avoid placing cabinets above the range. To reduce the hazard caused by reaching over the open flames of operating burners, install a ventilation hood over the range that projects forward at least 5" beyond the front of the cabinets.

- The ventilating hood must be constructed of sheet metal not less than 0.0122" thick. Install above the cooktop with a clearance of not less than 1/4" between the hood and the underside of the combustible material or metal cabinet. The hood must be at least as wide as the appliance and centered over the appliance. Clearance between the cooking surface and the ventilation hood surface **MUST NEVER BE LESS THAN 24 INCHES.**

EXCEPTION: Installation of a listed microwave oven or cooking appliance over the cooktop shall conform to the installation instructions packed with that appliance.

- If cabinets are placed above the range, allow a minimum clearance of 30" between the cooking surface and the bottom of unprotected cabinets.
- If a 30" clearance between cooking surface and overhead combustible material or metal cabinets cannot be maintained, protect the underside of the cabinets above the cooktop with not less than 1/4" insulating millboard covered with sheet metal not less than 0.0122" thick. Clearance between the cooking surface and protected cabinets **MUST NEVER BE LESS THAN 24 INCHES.**
- The vertical distance from the plane of the cooking surface to the bottom of adjacent overhead cabinets extending closer than 1" to the plane of the range sides must not be less than 18". (See the *Dimensions and Clearances* illustration in this section.)
- **CAUTION** — Items of interest to children should not be stored in cabinets above a range or on the backsplash of a range—children climbing on the range to reach items could be seriously injured.

Installation Instructions

DIMENSIONS AND CLEARANCES

Provide adequate clearances between the range and adjacent combustible surfaces. These dimensions must be met for safe use of your range. The location of the electrical outlet and pipe opening (see Gas Pipe and Electric Outlet Locations) may be adjusted to meet specific requirements.

The range may be placed with 0" clearance (flush) at the back wall.

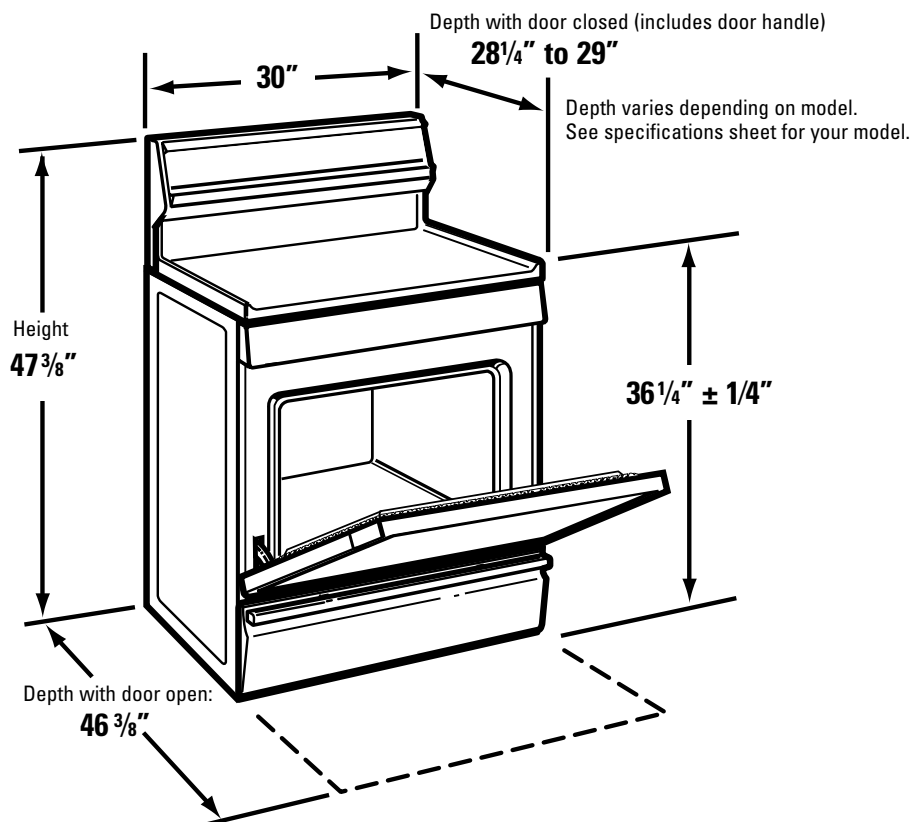
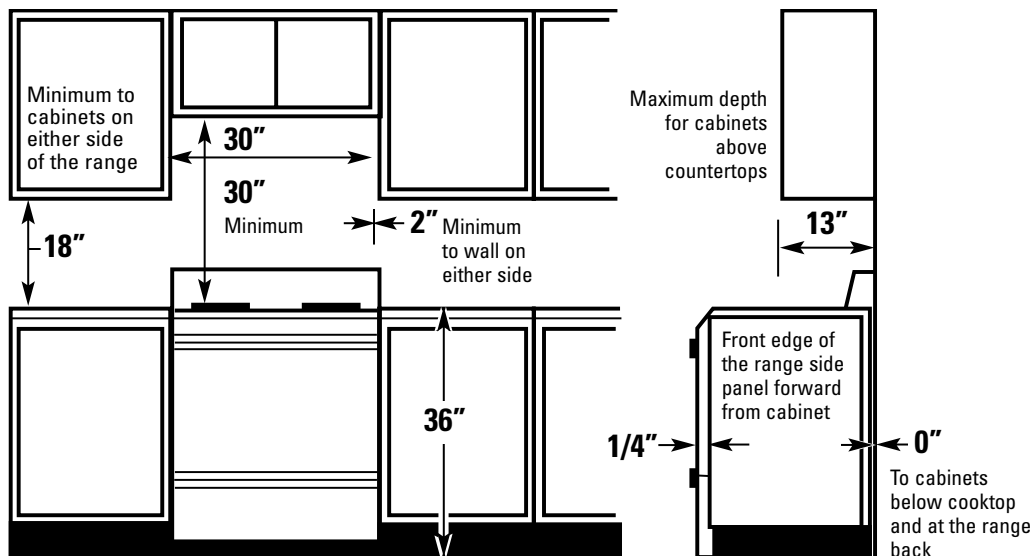

Installation Instructions

⚠ WARNING! **ANTI-TIP DEVICE**



All ranges can tip and injury could result.



To prevent accidental tipping of the range, attach an approved Anti-Tip device to the wall. (See *Installing the Anti-Tip Device* in this section.) To check if the device is installed and engaged properly, carefully tip the range forward. The Anti-Tip device should engage and prevent the range from tipping over.

If you pull the range out from the wall for any reason, make sure the Anti-Tip device is engaged when you push the range back against the wall.

- For your safety, never use your range for warming or heating the room. Your oven and cooktop are not designed to heat your kitchen. Top burners should not be operated without cookware on the grate. Such abuse could result in fire and damage to your range.
- Do not store or use combustible materials, gasoline or other flammable vapors and liquids in the vicinity of this or any other appliance. Explosions or fires could result.
- Do not use oven for a storage area. Items stored in the oven can ignite.
- Do not let cooking grease or other flammable materials accumulate in or near the range.

LOCATION

Do not locate the range where it may be subject to strong drafts. Any openings in the floor or wall behind the range should be sealed. Make sure the openings around the base of the range that supply fresh air for combustion and ventilation are not obstructed by carpeting or woodwork.

Your range, like many other household items, is heavy and can settle into soft floor coverings such as cushioned vinyl or carpeting. Use care when moving the range on this type of flooring. It is recommended that the following simple and inexpensive instructions be followed to protect your floor.

The range should be installed on a sheet of plywood (or similar material). When the floor covering ends at the front of the range, the area that the range will rest on should be built up with plywood to the same level or higher than the floor covering.

This will allow the range to be moved for cleaning or servicing. Also, make sure your floor covering will withstand 180°F. (See the *Installation Safety Instructions* section.)

Make sure the wall coverings around your range can withstand the heat generated (up to 200°F) by the range. (See the *Installation Safety Instructions* section.)

IMPORTANT!

Remove all tape and packaging. Make sure the burners are properly seated and level.

Take the accessory pack out of the oven and/or drawer.

Check to be sure that no range parts have come loose during shipping.

Installation Instructions

1 PROVIDE ADEQUATE GAS SUPPLY

Your range is designed to operate at a pressure of 10" of water column on LP gas (propane or butane) or, if designed for natural gas, 4" of water column.

Make sure you are supplying your range with the type of gas for which it is designed.

This range is convertible for use on natural or propane gas. If you decide to use this range on natural gas, conversion must be made by a qualified installer before attempting to operate the range on that gas.

For proper operation, the pressure of LP gas supplied to the regulator must be between 10" and 13" of water column.

For natural gas, the pressure supplied must be between 4" and 13" of water column.

When checking for proper operation of the regulator, the inlet pressure must be at least 1" greater than the operating (manifold) pressure as given above.

The pressure regulator located at the inlet of the range manifold must remain in the supply line regardless of whether LP or natural gas is being used.

A flexible metal appliance connector used to connect the range to the gas supply line should have an I.D. of 1/2" and be 5 feet in length for ease of installation. In Canada, flexible connectors must be single wall metal connectors no longer than 6 feet in length.

2 CONNECT THE RANGE TO GAS

Shut off the main gas supply valve before disconnecting the old range and leave it off until the new hookup has been completed. Don't forget to relight the pilot on other gas appliances when you turn the gas back on.

Because hard piping restricts movement of the range, the use of a CSA International-certified flexible metal appliance connector is recommended unless local codes require a hard-piped connection.

Never use an old connector when installing a new range. If the hard piping method is used, you must carefully align the pipe; the range cannot be moved after the connection is made.

To prevent gas leaks, put pipe joint compound on, or wrap pipe thread tape with Teflon* around, all male (external) pipe threads.

A. Install a manual gas line shut-off valve in the gas line in an easily accessed location outside of the range. Make sure everyone operating the range knows where and how to shut off the gas supply to the range.

B. Install male 1/2" flare union adapter to the 1/2" NPT internal thread at inlet of regulator. Use a backup wrench on the regulator fitting to avoid damage.

When installing the range from the front, remove the 90° elbow for easier installation.

C. Install male 1/2" or 3/4" flare union adapter to the NPT internal thread of the manual shut-off valve, taking care to back-up the shut-off valve to keep it from turning.

D. Connect flexible metal appliance connector to the adapter on the range. Position range to permit connection at the shut-off valve.

E. When all connections have been made, make sure all range controls are in the off position and turn on the main gas supply valve. Use a liquid leak detector at all joints and connections to check for leaks in the system.

When using test pressures greater than 1/2 psig to pressure test the gas supply system of the residence, disconnect the range and individual shut-off valve

WARNING: DO NOT USE A FLAME TO CHECK FOR GAS LEAKS.

from the gas supply piping. When using test pressures of 1/2 psig or less to test the gas supply system, simply isolate the range from the gas supply system by closing the individual shut-off valve.

*Teflon: Registered trademark of DuPont

Installation Instructions

GAS PIPE AND ELECTRICAL OUTLET LOCATIONS

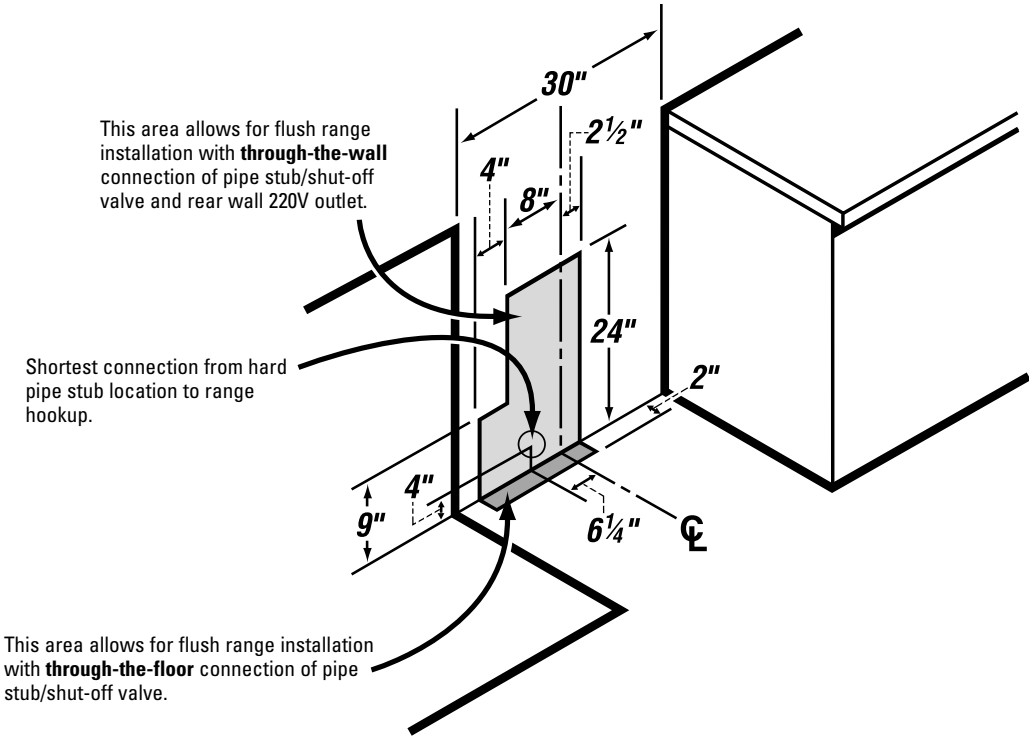

Installation Instructions

FLEXIBLE CONNECTOR HOOKUP

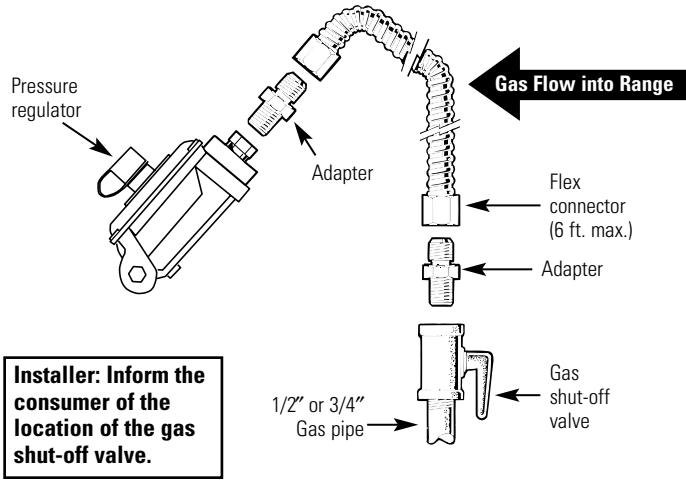

RIGID PIPE HOOKUP OPTIONS

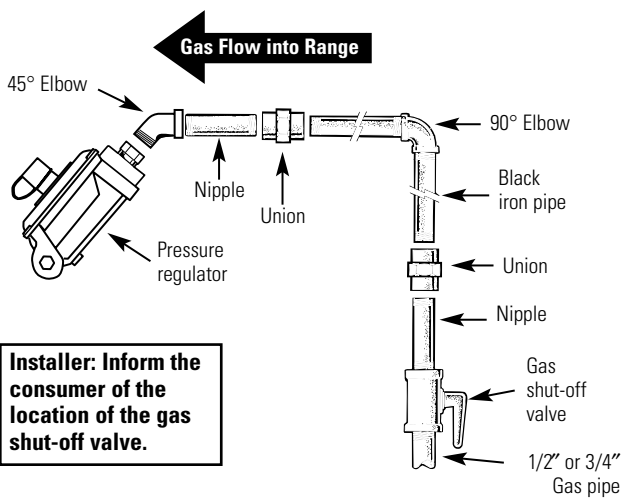

Alternate Hookup

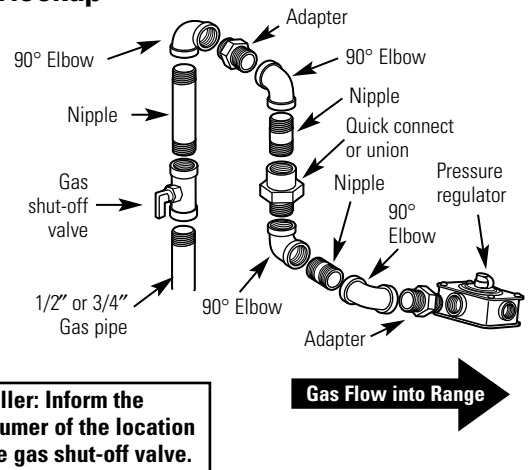

Installation Instructions

3 ELECTRICAL CONNECTIONS

Electrical Requirements

220-volt, 50 or 60 Hertz (depending on your model), properly grounded branch circuit protected by a 15-amp or 20-amp circuit breaker or time delay fuse.

Extension Cord Cautions

Because of potential safety hazards associated with certain conditions, we strongly recommend against the use of an extension cord. However, if you still elect to use an extension cord, it is absolutely necessary that it be a UL-listed, 3-wire grounding-type appliance extension cord and that the current carrying rating of the cord in amperes be equivalent to, or greater than, the branch circuit rating.

Grounding

IMPORTANT—(Please read carefully)

FOR PERSONAL SAFETY, THIS APPLIANCE MUST BE PROPERLY GROUNDED.

Preferred Method

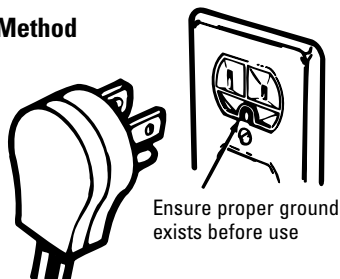

The power cord of this appliance is equipped with a 3-prong (grounding) plug which mates with a standard three-prong grounding wall receptacle to minimize the possibility of electric shock hazard from this appliance.

The customer should have the wall receptacle and circuit checked by a qualified electrician to make sure the receptacle is properly grounded.

Where a standard two-prong wall receptacle is encountered, it is the personal responsibility and obligation of the customer to have it replaced with a properly grounded three-prong wall receptacle.

DO NOT, UNDER ANY CIRCUMSTANCES, CUT OR REMOVE THE THIRD (GROUND) PRONG FROM THE POWER CORD.

A word about GFCI's – GFCI's are not required or recommended for gas range receptacles.

Ground Fault Circuit Interrupters (GFCI's) are devices that sense leakage of current in a circuit and automatically switch off power when a threshold leakage level is detected. These devices must be manually reset by the consumer. The National Electrical Code requires the use of GFCI's in kitchen receptacles installed to serve countertop surfaces. Performance of the range will not be affected if operated on a GFCI-protected circuit but occasional nuisance tripping of the GFCI breaker is possible.

3 ELECTRICAL CONNECTIONS (CONT.)

A. Usage Situations where Appliance Power Cord will be Disconnected Infrequently.

An adapter may be used only on a 15-amp circuit. Do not use an adapter on a 20-amp circuit. Where local codes permit, a **TEMPORARY CONNECTION** may be made to a properly grounded two-prong wall receptacle by the use of a UL-listed adapter, available at most hardware stores. The larger slot in the adapter must be aligned with the larger slot in the wall receptacle to provide proper polarity in the connection of the power cord.

Temporary Method

(Adapter plugs not permitted in Canada)

Align large prongs/slots

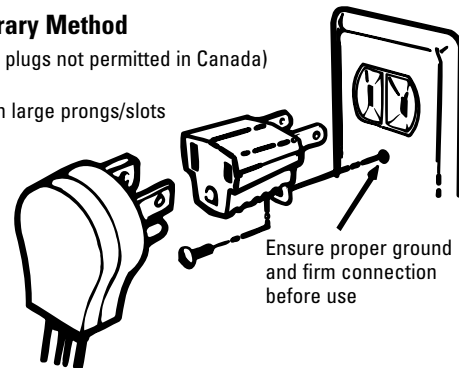

Ensure proper ground and firm connection before use

CAUTION: Attaching the adapter ground terminal to the wall receptacle cover screw does not ground the appliance unless the cover screw is metal, and not insulated, and the wall receptacle is grounded through the house wiring. The customer should have the circuit checked by a qualified electrician to make sure the receptacle is properly grounded.

When disconnecting the power cord from the adapter, always hold the adapter with one hand. If this is not done, the adapter ground terminal is very likely to break with repeated use. Should this happen, **DO NOT USE** the appliance until a proper ground has again been established.

Installation Instructions

3 ELECTRICAL CONNECTIONS (CONT.)

B. Usage Situations where Appliance Power Cord will be Disconnected Frequently.

Do not use an adapter plug in these situations because disconnecting of the power cord places undue strain on the adapter and leads to eventual failure of the adapter ground terminal. The customer should have the 2-prong wall receptacle replaced with a three-prong (grounding) receptacle by a qualified electrician before using the appliance.

The installation of appliances designed for mobile home installation must conform with the Manufactured Home Construction and Safety Standard, Title 24 CFR, Part 3280 (formerly the Federal Standard for Mobile Home Construction and Safety, Title 24, HUD, Part 280) or, when such standard is not applicable, the Standard for Manufactured Home Installations, latest edition (Manufactured Home Sites, Communities and Set-Ups), ANSI A225.1, latest edition, or with local codes. In Canada, mobile home installation must be in accordance with the current CAN/CSA Z240/MH Mobile Home Installation Code.

Electric Disconnect

- Locate disconnect plug on the range back.
- Pinch sides of connector and pull out of range back.

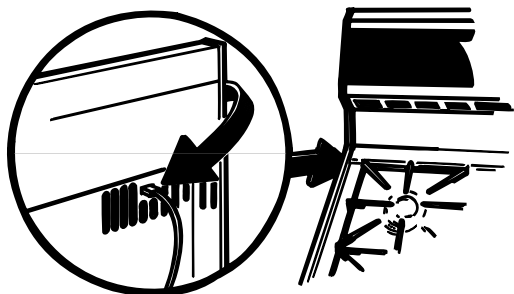

4 SEAL THE OPENINGS

Seal any openings in the wall behind the range and in the floor under the range when hookups are completed.

5 CHECK IGNITION OF SURFACE BURNERS

Operation of all cooktop and oven burners should be checked after the range and gas supply lines have been carefully checked for leaks.

Electric Ignition Models

Select a top burner knob and simultaneously push in and turn to **LITE** position. You will hear a **clicking** sound indicating proper operation of the spark module. Once the air has been purged from the supply lines, burners should light within 4 seconds. After burner lights, rotate knob out of the **LITE** position. Try each burner in succession until all burners have been checked.

Quality of Flames

The combustion quality of burner flames needs to be determined visually.

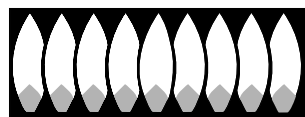

(A) **Yellow flames**—
Call for service

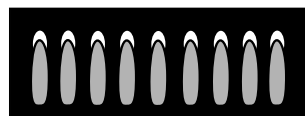

(B) **Yellow tips on outer cones**—
Normal for LP gas



(C) **Soft blue flames**—Normal for
natural gas

If burner flames look like (A), call for service. Normal burner flames should look like (B) or (C), depending on the type of gas you use.

With LP gas, some yellow tipping on outer cones is normal.

6 CHECK IGNITION OF OVEN BURNER

The oven is designed to operate quietly and automatically. To operate the oven, press the **BAKE** pad and then press the number pads until **350°** appears in the display. Touch the **START** pad. After 30–90 seconds, the oven burner will ignite and burn until the set temperature is reached. The oven burner will continue to cycle on and off as necessary to maintain the oven at the temperature indicated by the display.

To check ignition of the broil burner, touch the **BROIL HI/LO** pad and then the **START** pad. After 30–90 seconds, the broil burner will ignite.

Electric ignition models require electrical power to operate. In case of a power outage, the oven burners on these models cannot be lit manually with a match. Gas will not flow unless the glow bar is hot.

If the oven is in use when a power outage occurs, the burner will shut off and cannot be re-lit until power is restored.

Installation Instructions

7 ADJUST BROIL AND OVEN BURNER AIR ADJUSTMENT SHUTTERS IF NECESSARY

Air adjustment shutters for the top and bottom burners regulate the flow of air to the flames.

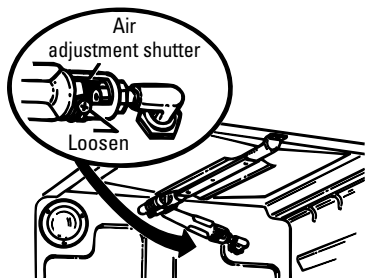

The air adjustment shutter for the top (broil) burner is in the center of the rear wall of the oven.

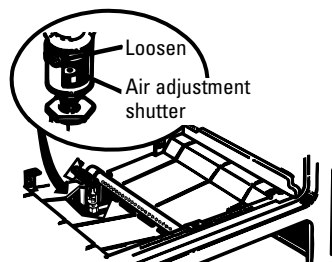

The shutter for the bottom (oven) burner is near the back wall behind the storage drawer. Remove the drawer. See the *Care and cleaning of the range* section.

To adjust the flow of air to either burner, loosen the Phillips head screw and rotate the shutter toward open or closed position as needed.

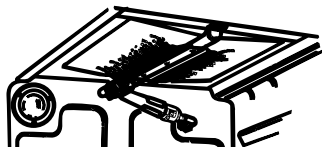

The flames for the top (broil) burner should be steady with approximately 1" blue cones and should not extend out over the edges of the burner baffle.

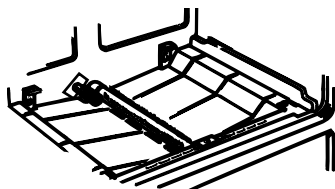

To determine if the bottom burner flames are burning properly, remove the oven bottom. Flames should have approximately 1" blue cones and, if range is supplied with natural gas, should burn with no yellow tipping. (With most LP gas, small yellow tips at the end of outer cones are normal.) Flames should not lift off burner ports. If lifting is observed, gradually reduce air shutter opening until flames are stabilized.

7 ADJUST BROIL AND OVEN BURNER AIR ADJUSTMENT SHUTTERS IF NECESSARY (CONT.)

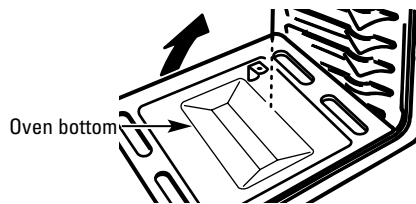

To remove the oven bottom:

- Remove the knurled screws holding down rear of the oven bottom.
- Grasp the oven bottom at finger slots on each side.
- Lift the rear of the oven bottom enough to clear the lip of the range frame, push it back, and then pull it up and out.

8 LEVELING THE RANGE

- Install the oven shelves in the oven and position the range where it will be installed.

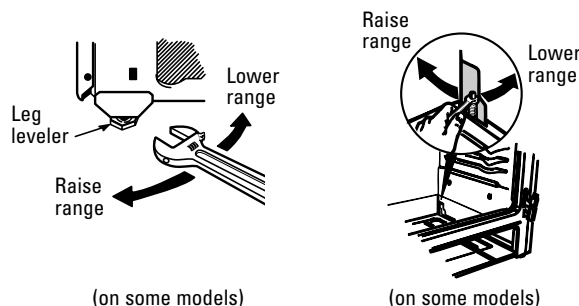

- Check for levelness by placing a spirit level or a cup, partially filled with water, on one of the oven shelves. If using a spirit level, take two readings—with the level placed diagonally first in one direction and then the other.
- Remove the storage drawer. See the *Care and cleaning of the range* section. The front leveling legs can be adjusted from the bottom and the rear legs can be adjusted from the top or the bottom.
- Use an open-end or adjustable wrench to adjust the leveling legs until the range is level.
- After the range is level, slide the range away from the wall so that the Anti-Tip device can be installed.

Installation Instructions

9 INSTALLING THE ANTI-TIP DEVICE

⚠ WARNING!

- Range must be secured with an approved Anti-Tip device.
- Unless properly installed, the range could be tipped by you or a child standing, sitting or leaning on an open door.
- After installing the Anti-Tip device, verify that it is in place by carefully attempting to tilt the range forward.
- This range has been designed to meet all recognized industry tip standards for all normal conditions.
- The use of this device does not preclude tipping of the range when not properly installed.
- If the Anti-Tip device supplied with the range does not fit this application, use the universal Anti-Tip device WB2X7909.

- A. Mark the wall where the **RIGHT EDGE** of the range is to be located. Be sure to allow for the countertop overhang if you intend to install the range next to cabinets.

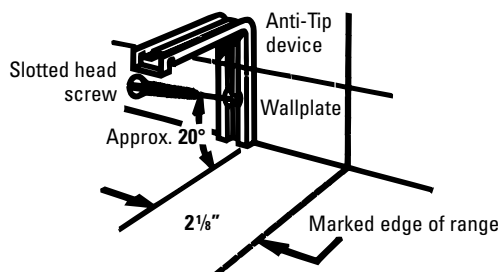

- B. Locate the outside edge of the device $2\frac{1}{8}$ " toward the center of the range from the marked edge of the range.
- C. Using the device as a template, mark the position of the hole for the screw.
- D. For wood construction, drill a pilot hole at an angle of 20 degrees from the horizontal. A nail or awl may be used if a drill is not available.

Mount the Anti-Tip device with the screw provided.

For cement or concrete construction, you will need a $1/4$ " x $1\frac{1}{2}$ " lag bolt and a $1/2$ " O.D. sleeve anchor, which are not provided. Drill the recommended size hole for the hardware.

9 INSTALLING THE ANTI-TIP DEVICE (CONT.)

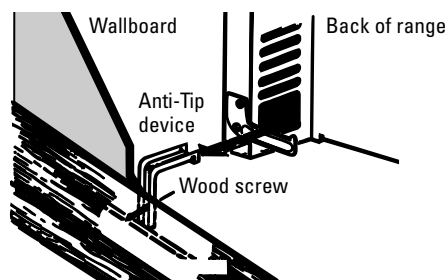

Install the sleeve anchor into the drilled hole and then install the lag bolt through the device. The bolts must be properly tightened as recommended for the hardware.

- E. Slide the range against the wall, and check for proper installation by grasping the front edge of the cooktop and carefully attempting to tilt the range forward.

WHEN ALL HOOKUPS ARE COMPLETED

Make sure all controls are left in the off position. Make sure the flow of combustion and ventilation air to the range is unobstructed.

Before you call for service...



Troubleshooting Tips
Save time and money! Review the charts on the following pages first and you may not need to call for service.

Problem	Possible Causes	What To Do
Top burners do not light or do not burn evenly	Plug on range is not completely inserted in the electrical outlet.	<ul style="list-style-type: none"> Make sure electrical plug is plugged into a live, properly grounded outlet.
	Burner hole or slits on the side of the burner may be clogged.	<ul style="list-style-type: none"> Remove the burner heads and clean them. Check the electrode area for burned-on food or grease. See the <i>Care and cleaning of the range</i> section.
	Improper burner assembly.	<ul style="list-style-type: none"> Make sure the burner parts are installed correctly. See the <i>Care and cleaning of the range</i> section.
Surface burners light but oven does not	The oven gas shut-off valve may have accidentally been moved during cleaning or moving.	<ul style="list-style-type: none"> To check the oven gas shut-off valve, remove the storage drawer or warming drawer (see the <i>Care and cleaning of the range</i> section) and look for the gas shut-off lever at the back of the range. <div data-bbox="896 806 1192 1037" data-label="Image"> </div>
Control signals after entering cooking time or start time	You forgot to enter a bake temperature or cleaning time.	<ul style="list-style-type: none"> Touch the BAKE pad and desired temperature or the SELF CLEAN pad and desired clean time.
Clock and timer do not work	Plug on range is not completely inserted in the electrical outlet.	<ul style="list-style-type: none"> Make sure electrical plug is plugged into a live, properly grounded outlet.
	A fuse in your home may be blown or the circuit breaker tripped.	<ul style="list-style-type: none"> Replace the fuse or reset the circuit breaker.
	Oven controls improperly set.	<ul style="list-style-type: none"> See the <i>Using the clock and timer</i> section.
Food does not bake or roast properly	Oven controls improperly set.	<ul style="list-style-type: none"> See the <i>Using the oven</i> section.
	Shelf position is incorrect.	<ul style="list-style-type: none"> See the <i>Using the oven</i> section.
	Incorrect cookware or cookware of improper size being used.	<ul style="list-style-type: none"> See the <i>Using the oven</i> section.
	Oven thermostat needs adjustment.	<ul style="list-style-type: none"> See the <i>Adjust the oven thermostat—Do it yourself!</i> section.
	Clock not set correctly.	<ul style="list-style-type: none"> See the <i>Using the clock and timer</i> section.
	Aluminum foil used improperly in the oven.	<ul style="list-style-type: none"> See the <i>Care and cleaning of the range</i> section.
	Oven bottom not securely seated in position.	<ul style="list-style-type: none"> See the <i>Installation of the range</i> section.

Problem	Possible Causes	What To Do
Food does not broil properly	Oven controls improperly set.	• Make sure you touch the BROIL HI/LO pad.
	Oven door not closed.	• See the <i>Using the oven</i> section.
	Improper shelf position being used.	• See the <i>Broiling Guide</i> .
	Food being cooked in a hot pan.	• Use the broiling pan and grid that came with your range. Make sure it is cool.
	Cookware not suited for broiling.	• Use the broiling pan and grid that came with your range.
	Aluminum foil used on the the broiling pan and grid has not been fitted properly and slit as recommended.	• See the <i>Using the oven</i> section.
	Oven bottom not securely seated in position.	• See the <i>Installation of the range</i> section.
Oven temperature too hot or too cold	Oven thermostat needs adjustment.	• See the <i>Adjust the oven thermostat—Do it yourself!</i> section.
Oven light does not work	Light bulb is loose or defective.	• Tighten or replace the bulb.
	Plug on range is not completely inserted in the electrical outlet.	• Make sure electrical plug is plugged into a live, properly grounded outlet.
Oven will not self-clean	The oven temperature is too high to set a self-clean operation.	• Allow the range to cool to room temperature and reset the controls.
	Oven controls improperly set.	• See the <i>Using the self-cleaning oven</i> section.
	On models with a door latch, the oven door is not in the locked position.	• Make sure you move the door latch handle all the way to the right.
“Crackling” or “popping” sound	This is the sound of the metal heating and cooling during both the cooking and cleaning functions.	• This is normal.
Excessive smoking	Excessive soil.	• Touch the CLEAR/OFF pad. Open the windows to rid the room of smoke. Wait until the LOCKED DOOR light goes off. Wipe up the excess soil and reset the clean cycle.
Oven door will not open after a clean cycle	Oven too hot.	• Allow the oven to cool below locking temperature.
Oven not clean after a clean cycle	Oven controls not properly set.	• See the <i>Using the self-cleaning oven</i> section.
	Oven was heavily soiled.	• Clean up heavy spillovers before starting the clean cycle. Heavily soiled ovens may need to self-clean again or for a longer period of time.

Before you call for service...



Troubleshooting Tips

Problem	Possible Causes	What To Do
"LOCK DOOR" flashes in the display	The self-clean cycle has been selected but the door is not closed.	<ul style="list-style-type: none"> Close the oven door.
LOCKED DOOR light is on when you want to cook	The oven door is locked because the temperature inside the oven has not dropped below the locking temperature.	<ul style="list-style-type: none"> Touch the CLEAR/OFF pad. Allow the oven to cool and then, on models with a door latch, unlock the door.
Oven door will not unlock (on models with a door latch)	Oven is too hot.	<ul style="list-style-type: none"> Allow the oven to cool below locking temperature. Do not lock the door with the door latch except when using the self-clean feature.
"Door" appears in the display (on models with a door latch)	Self-cleaning cycle has been selected but the latch handle was not moved all the way to the right.	<ul style="list-style-type: none"> Move the latch handle all the way to the right.
	Latch handle was moved to the right but a program other than self-cleaning was selected.	<ul style="list-style-type: none"> Move the latch handle to the right only when setting the self-cleaning cycle.
"F—and a number or letter" flash in the display	On models with a door latch, if a function error code appears during the self-cleaning cycle, check the oven door latch.	<ul style="list-style-type: none"> The latch may have been moved, even if only slightly, from the locked position. Make sure the latch is moved to the right as far as it will go.
	You have a function error code.	<ul style="list-style-type: none"> Touch the CLEAR/OFF pad. Allow the oven to cool for one hour. Put the oven back into operation.
	If the function code repeats.	<ul style="list-style-type: none"> Disconnect all power to the range for 5 minutes and then reconnect power. If the function error code repeats, call for service.
Display goes blank	A fuse in your home may be blown or the circuit breaker tripped.	<ul style="list-style-type: none"> Replace the fuse or reset the circuit breaker.
	The clock is in the black-out mode.	<ul style="list-style-type: none"> See the <i>Special features of your oven control</i> section.
Display flashes	Power failure.	<ul style="list-style-type: none"> Reset the clock.
Unable to get the display to show "SF"	Oven control pads were not touched properly.	<ul style="list-style-type: none"> The BAKE and BROIL HI/LO pads must be touched at the same time and held for 3 seconds.
Power outage, clock flashes	Power outage or surge.	<ul style="list-style-type: none"> Reset the clock. If the oven was in use, you must reset it by touching the CLEAR/OFF pad, setting the clock and resetting any cooking function.

Safety Instructions

Operating Instructions

Care and Cleaning

Installation Instructions

Troubleshooting Tips

Problem	Possible Causes	What To Do
"Burning" or "oily" odor emitting from the vent	This is normal in a new oven and will disappear in time.	<ul style="list-style-type: none"> To speed the process, set a self-clean cycle for a minimum of 3 hours. See the <i>Using the self-cleaning oven</i> section.
Strong odor	An odor from the insulation around the inside of the oven is normal for the first few times the oven is used.	<ul style="list-style-type: none"> This is temporary.
Drawer does not slide smoothly or drags	The drawer is out of alignment.	<ul style="list-style-type: none"> Fully extend the drawer and push it all the way in. See the <i>Care and cleaning of the range</i> section.
	Drawer is overloaded or load is unbalanced.	<ul style="list-style-type: none"> Reduce weight. Redistribute drawer contents.

Troubleshooting Tips	Installation Instructions	Care and Cleaning	Operating Instructions	Safety Instructions
-----------------------------	----------------------------------	--------------------------	-------------------------------	----------------------------

Notes.

Notes.

<i>Safety Instructions</i>	<i>Operating Instructions</i>	<i>Care and Cleaning</i>	<i>Installation Instructions</i>	<i>Troubleshooting Tips</i>
-----------------------------------	--------------------------------------	---------------------------------	---	------------------------------------

Accessories.



Looking For Something More?

You can find these accessories and many more at www.GEAppliances.com, or call **800.626.2002** (during normal business hours). Have your model number ready.

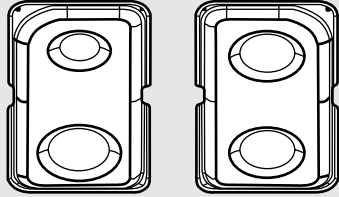

Drip Pans

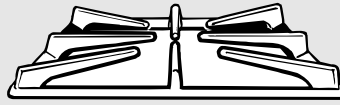

Grates

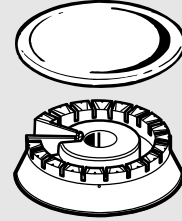

Surface Burners & Caps

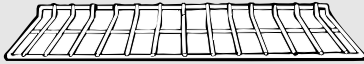

Oven Racks

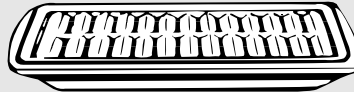

Broiler Pan



Cleaner



Light Bulbs

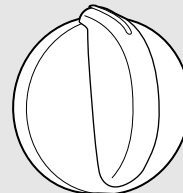

Knobs

Tired of discolored racks? Wishing you had extra-heavy-duty oven racks?

NOW AVAILABLE for your range:

GE's innovative, self-cleanable porcelain-coated oven racks!

- Heavy Duty
- Durable
- Able to be cleaned in a self-cleaning oven

Visit www.GEAppliances.com for more information.