



Use and Care & Installation Guide

XL44™ Self-Cleaning Gas Range



Safety Instructions	2-5
Anti-Tip Device	2, 3, 36, 44



Operating Instructions, Tips	
Aluminum Foil	5, 16, 21-23, 25
Clock and Timer	11, 12
Features	6, 7
Oven	13-28
Baking	15-17
Broiling, Broiling Guide	23, 24
Door Latch	11, 15, 21, 23, 25-27
Electric Ignition	13
Light; Bulb Replacement	13, 33
Oven Control	11, 12
Preheating	15
Roasting, Roasting Guide	21, 22
Self-Cleaning Instructions	25-28
Shelves	5, 14-16, 21, 25
Timed Baking	18, 19
Surface Cooking	8-10
Control Settings	9
Cooktop Comparison	8



Care and Cleaning	29-34
Broiler Pan and Grid	32
Burner Assembly	29-31
Cooktop	31, 34
Door Removal	32
Oven Bottom	31
Oven Vents	34
Self-Cleaning Instructions	25-28
Storage Drawer	33



Before You Call For Service	45-47
Thermostat Adjustment— <i>Do It Yourself</i>	20



Preparation	35-44
Air Adjustment	43
Flame Size	9, 42
Flooring Under the Range	37
Installation Instructions	35-44
Leveling	44

Model: JGBP35GRA 120V, 60Hz

GE Appliances

Part No. 183D5580P056
Pub No. 49-8919



HELP US HELP YOU...

Read this guide carefully.

It is intended to help you operate and maintain your new range properly.

Keep it handy for answers to your questions.

If you received a damaged range...

Immediately contact the dealer (or builder) that sold you the range.

Save time and money. Before you request service...

Check the Before You Call for Service section in the back of this guide. It lists causes of minor operating problems that you can correct yourself.

	⚠ WARNING
	<ul style="list-style-type: none"> • ALL RANGES CAN TIP • INJURY TO PERSONS COULD RESULT
	<ul style="list-style-type: none"> • INSTALL ANTI-TIP DEVICES PACKED WITH RANGE • SEE INSTALLATION INSTRUCTIONS

WARNING: If the information in this guide is not followed exactly, a fire or explosion may result causing property damage, personal injury or death.

- Do not store or use gasoline or other flammable vapors and liquids in the vicinity of this or any other appliance.
- WHAT TO DO IF YOU SMELL GAS
 - Do not try to light any appliance.
 - Do not touch any electrical switch; do not use any phone in your building.
 - Immediately call your gas supplier from a neighbor's phone. Follow the gas supplier's instructions.
 - If you cannot reach your gas supplier, call the fire department.
- Installation and service must be performed by a qualified installer, service agency or the gas supplier.

IMPORTANT SAFETY INSTRUCTIONS

Read all instructions before using this appliance.



IMPORTANT SAFETY NOTICE

- **The California Safe Drinking Water and Toxic Enforcement Act** requires the Governor of California to publish a list of substances known to the state to cause cancer, birth defects or other reproductive harm, and requires businesses to warn customers of potential exposure to such substances.

Gas appliances can cause minor exposure to four of these substances, namely benzene, carbon monoxide, formaldehyde and soot, caused primarily by the incomplete combustion of LP with high butane gas content. Properly adjusted burners, indicated by a bluish rather than a yellow flame, will minimize incomplete combustion. Exposure to these substances can be minimized by venting with an open window or using a ventilation fan or hood.

- **Fluorescent light bulbs and safety valves on standing pilot ranges contain mercury.** If your model has these features, they must be recycled according to local, state and federal codes.

When You Get Your Range

- **Have the installer show you the location of the range gas shut-off valve and how to shut it off if necessary.**
- **Have your range installed and properly grounded by a qualified installer**, in accordance with the Installation Instructions. Any adjustment and service should be performed only by qualified gas range installers or service technicians.
- **Do not attempt to repair or replace any part of your range unless it is specifically recommended in this guide.** All other servicing should be referred to a qualified technician.
- **Plug your range into a 120-volt grounded outlet only.** Do not remove the round grounding prong from the plug. If in doubt about the grounding of the home electrical system, it is your personal responsibility and obligation to have an ungrounded outlet replaced with a properly grounded, three-prong outlet in accordance with the National Electrical Code. In Canada, the appliance must be electrically grounded in accordance with the Canadian Electrical Code. Do not use an extension cord with this appliance.
- **Locate the range out of kitchen traffic path and out of drafty locations to prevent pilot outage (on standing pilot models) and poor air circulation.**

- **Be sure all packing materials are removed from the range** before operating it to prevent fire or smoke damage should the packing material ignite.

- **Be sure your range is correctly adjusted by a qualified service technician or installer.**

WARNING: These adjustments must be made by a qualified service technician in accordance with the manufacturer's instructions and all codes and requirements of the authority having jurisdiction. Failure to follow these instructions could result in serious injury or property damage.

- **After prolonged use of a range, high floor temperatures may result and many floor coverings will not withstand this kind of use.** Never install the range over vinyl tile or linoleum that cannot withstand such type of use. Never install it directly over interior kitchen carpeting.

Using Your Range

▲ WARNING—All ranges can tip and injury could result. To prevent accidental tipping of the range, attach it to the wall by installing the Anti-Tip device supplied.



To check if the device is installed and engaged properly, carefully tip the range forward. The Anti-Tip device should engage and prevent the range from tipping over.

If you pull the range out from the wall for any reason, make sure the device is properly engaged when you push the range back against the wall. If it is not, there is a possible risk of the range tipping over and causing injury if you or a child stand, sit or lean on an open door.

Please refer to the Anti-Tip device information in this guide. Failure to take this precaution could result in tipping of the range and injury.

- **Do not leave children alone or unattended where a range is hot or in operation.** They could be seriously burned.
- **For your safety, never use your appliance for warming or heating the room.**

(continued next page)



IMPORTANT SAFETY INSTRUCTIONS

(continued)

- **CAUTION: ITEMS OF INTEREST TO CHILDREN SHOULD NOT BE STORED IN CABINETS ABOVE A RANGE OR ON THE BACKSPASH OF A RANGE—CHILDREN CLIMBING ON THE RANGE TO REACH ITEMS COULD BE SERIOUSLY INJURED.**
- **Do not allow anyone to climb, stand or hang on the door, storage drawer or cooktop.** They could damage the range and even tip it over, causing severe personal injury.
- **Let the burner grates and other surfaces cool before touching them or leaving them where children can reach them.**
- **Never wear loose fitting or hanging garments while using the appliance.** Be careful when reaching for items stored in cabinets over the cooktop. Flammable material could be ignited if brought in contact with flame or hot oven surfaces and may cause severe burns.
- **Do not use water on grease fires. Never pick up a flaming pan.** Turn the controls off. Smother a flaming pan on a surface unit by covering the pan completely with a well-fitting lid, cookie sheet or flat tray. Use a multi-purpose dry chemical or foam-type fire extinguisher.
Flaming grease outside a pan can be put out by covering it with baking soda or, if available, by using a multi-purpose dry chemical or foam-type fire extinguisher.
Flame in the oven can be smothered completely by closing the oven door and turning the oven off or by using a multi-purpose dry chemical or foam-type fire extinguisher.
- **Do not store flammable materials in an oven, a storage drawer or near a cooktop.**
- **DO NOT STORE OR USE COMBUSTIBLE MATERIALS, GASOLINE OR OTHER FLAMMABLE VAPORS AND LIQUIDS IN THE VICINITY OF THIS OR ANY OTHER APPLIANCE.**
- **Do not let cooking grease or other flammable materials accumulate in or near the range.**
- **Cook meat and poultry thoroughly—meat to at least an INTERNAL temperature of 160°F. and poultry to at least an INTERNAL temperature of 180°F.** Cooking to these temperatures usually protects against foodborne illness.

Surface Cooking

- **Always heat fat slowly, and watch as it heats.**
- **Always use the LITE position (on electric ignition models) or the HI position (on standing pilot models) when igniting the top burners and make sure the burners have ignited.**
- **Never leave the surface burners unattended at high flame settings.** Boilovers cause smoking and greasy spillovers that may catch on fire.
- **Adjust the top burner flame size so it does not extend beyond the edge of the cookware.** Excessive flame is hazardous.
- **Use only dry pot holders—**moist or damp pot holders on hot surfaces may result in burns from steam.
- **Do not let pot holders come near open flames when lifting cookware.** Do not use a towel or other bulky cloth in place of a pot holder.
- **To minimize the possibility of burns,** ignition of flammable materials and spillage, turn cookware handles toward the side or back of the range without extending over adjacent burners.
- **Always turn the surface burners to off before removing cookware.**
- **Carefully watch foods being fried at a high flame setting.**
- **Never block the vents (air openings) of the range.** They provide the air inlet and outlet that are necessary for the range to operate properly with correct combustion. Air openings are located at the rear of the cooktop, at the top and bottom of the oven door, and at the bottom of the range under the storage drawer or kick panel.
- **Do not use a wok on models with sealed burners if the wok has a round metal ring that is placed over the burner grate to support the wok.** This ring acts as a heat trap, which may damage the burner grate and burner head. Also, it may cause the burner to work improperly. This may cause a carbon monoxide level above that allowed by current standards, resulting in a health hazard.
- **Foods for frying should be as dry as possible.** Frost on frozen foods or moisture on fresh foods can cause hot fat to bubble up and over the sides of the pan.
- **Use the least possible amount of fat for effective shallow or deep-fat frying.** Filling the pan too full of fat can cause spillovers when food is added.
- **Use a deep fat thermometer** whenever possible to prevent overheating fat beyond the smoking point.
- **Never try to move a pan of hot fat, especially a deep fat fryer.** Wait until the fat is cool.



- **When using glass cookware**, make sure it is designed for top-of-range cooking.
- **If a combination of oils or fats will be used in frying**, stir together before heating or as fats melt slowly.
- **Use proper pan size**—Avoid pans that are unstable or easily tipped. Select cookware having flat bottoms large enough to properly contain food and avoid boilovers and spillovers and large enough to cover burner grate. This will both save cleaning time and prevent hazardous accumulations of food, since heavy spattering or spillovers left on range can ignite. Use pans with handles that can be easily grasped and remain cool.
- **Keep all plastics away from the top burners.**

- **Do not leave plastic items on the cooktop**—they may melt if left too close to the vent.



Vent appearance and location vary

- **Do not leave any items on the cooktop.** The hot air from the vent may ignite flammable items and will increase pressure in closed containers, which may cause them to burst.
- **To avoid the possibility of a burn, always be certain that the controls for all burners are at the off position and all grates are cool before attempting to remove them.**
- **When flaming foods under the hood, turn the fan on.**
- **If range is located near a window**, do not hang long curtains that could blow over the top burners and create a fire hazard.
- **When a pilot goes out** (on standing pilot models), you will detect a faint odor of gas as your signal to relight the pilot. When relighting the pilot, make sure burner controls are in the off position, and follow instructions in this guide to relight.
- **If you smell gas**, and you have already made sure pilots are lit (on standing pilot models), turn off the gas to the range and call a qualified service technician. Never use an open flame to locate a leak.

Baking, Broiling and Roasting

- **Do not use the oven for a storage area.** Items stored in the oven can ignite.
- **Place the oven shelves in the desired position while the oven is cool.**
- **Stand away from the range when opening the door of a hot oven.** The hot air and steam that escapes can cause burns to hands, face and eyes.

- **Keep the oven free from grease buildup.**
- **Pulling out the shelf to the shelf-stop is a convenience in lifting heavy foods. It is also a precaution against burns from touching hot surfaces of the door or oven walls. The lowest position “R” is not designed to slide.**
- **Do not heat unopened food containers. Pressure could build up and the container could burst, causing an injury.**
- **Do not use aluminum foil anywhere in the oven except as described in this guide.** Misuse could result in a fire hazard or damage to the range.
- **Never use aluminum foil to line the oven bottom. Improper use of foil could start a fire.**
- **When using cooking or roasting bags in the oven**, follow the manufacturer’s directions.
- **Use only glass cookware that is recommended for use in gas ovens.**
- **Always remove the broiler pan from range as soon as you finish broiling.** Grease left in the pan can catch fire if oven is used without removing the grease from the broiler pan.
- **When broiling, if meat is too close to the flame, the fat may ignite.** Trim excess fat to prevent excessive flare-ups.
- **Make sure the broiler pan is in place correctly** to reduce the possibility of grease fires.
- **If you should have a grease fire in the broiler pan**, turn off oven control, and keep the oven door closed to contain fire until it burns out.

Self-Cleaning Oven

- **Clean only parts listed in this Use and Care Guide.**
- **Do not clean door gasket.** The door gasket is essential for a good seal. Care should be taken not to rub, damage or move the gasket.
- **Do not use oven cleaners.** No commercial oven cleaner or oven liner protective coating of any kind should be used in or around any part of the oven. Residue from oven cleaners will damage the inside of the oven when the self-clean cycle is used.
- **Before self-cleaning the oven, remove the shelves, the broiler pan and grid and other cookware.**
- **Be sure to wipe up excess spillage before starting the self-cleaning operation.**
- **If the self-cleaning mode malfunctions, turn the oven off and disconnect the power supply.** Have it serviced by a qualified technician.

**SAVE THESE
INSTRUCTIONS**



FEATURES OF YOUR RANGE

Features and appearance may vary.

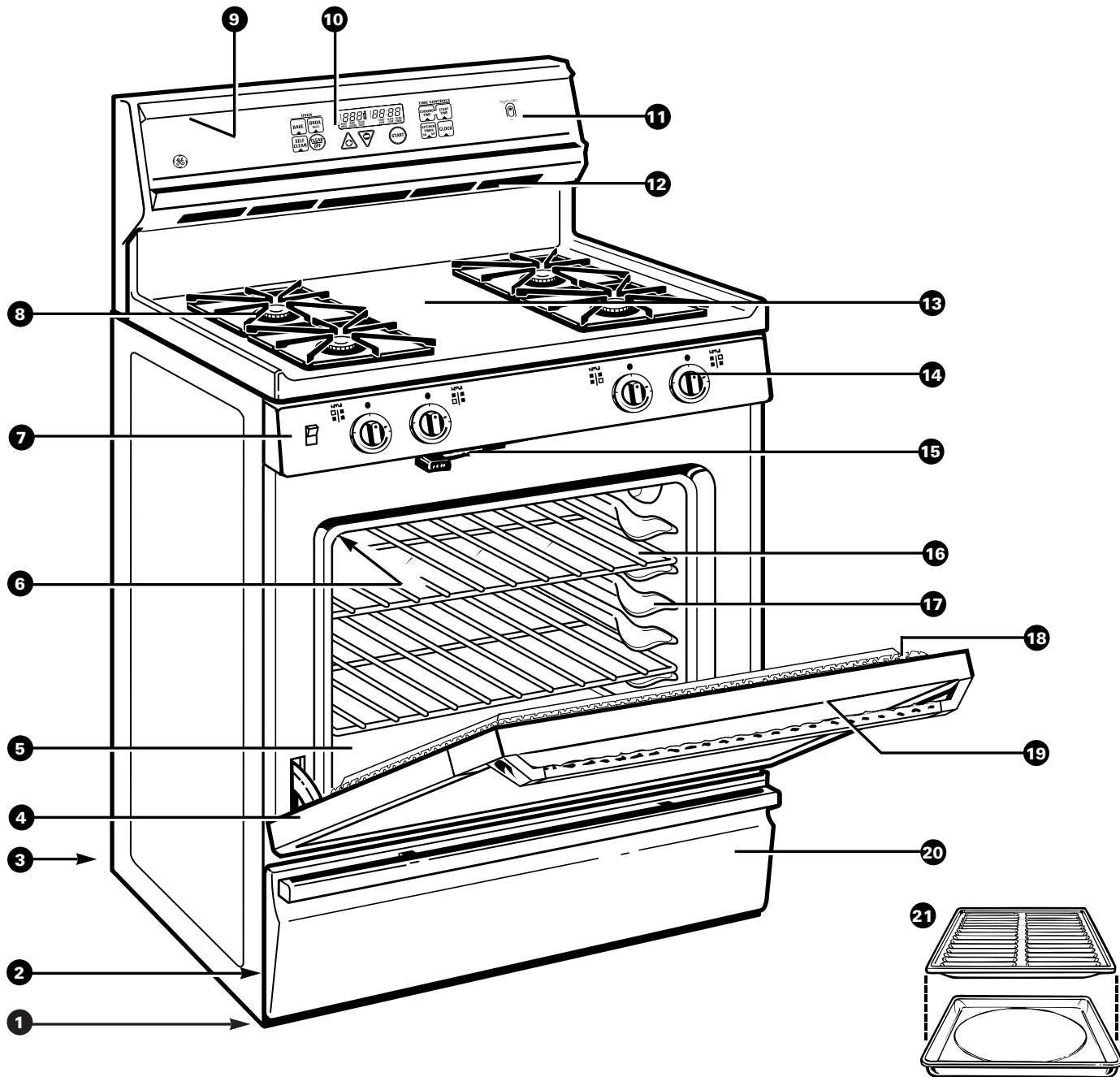

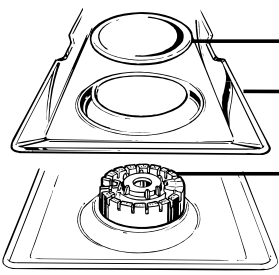
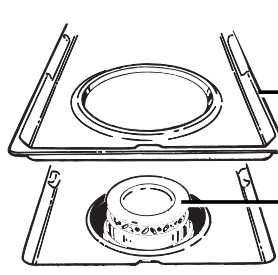
Sealed Burners	Standard Twin Burners
 <p>— Burner Cap — Drip Pan (on some models) — Burner Head</p>	 <p>— Drip Pan (on some models) — Burner</p>

Your range is equipped with one of the two types of surface burners shown above.

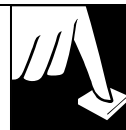

Feature Index (Not all models have all features. Appearance of features varies.)	See page
1 Air Intake (under storage drawer or kick panel)	4, 34
2 Model and Serial Numbers (on front frame of range, behind storage drawer or removable kick panel)	–
3 Anti-Tip Device Lower right rear corner on range back. See the Installation Instructions.	2, 3, 36, 44
4 Lift-Off Oven Door (easily removed for oven cleaning)	4, 23–28, 32
5 Oven Bottom	31
6 Oven Interior Light	13, 25, 33
7 Oven Light On/Off Switch	13
8 Grates, Drip Pans (on some models) and Surface Burners	4, 5, 8–10, 25, 29–31
9 Fluorescent Night Light (on some models)	3, 13, 34
10 Oven Control, Clock and Timer	11, 12, 15, 18–21, 23, 25–28, 33
11 Night Light Switch (on some models)	13
12 Oven Vents	4, 5, 14, 34
13 Cooktop	4, 5, 8–10, 31, 34
14 Surface Burner Control Knobs	4, 9, 33
15 Oven Door Latch (use for self-cleaning cycle only)	11, 15, 18, 21, 23, 26–28
16 Oven Shelves with Stop-Locks (easily removed or repositioned on shelf supports)	5, 14–17, 21, 24, 25, 32
17 Oven Shelf Supports Shelf positions for cooking are suggested in the Baking, Roasting and Broiling sections.	5, 14, 15, 21, 24, 32
18 Oven Door Gasket	5, 25, 32
19 Air Vent in Oven Door (top of oven door)	4, 5, 14, 34
20 Storage Drawer or Removable Kick Panel (depending on model)	4, 33, 34
21 Broiler Pan and Grid Do not clean in the self-cleaning oven.	5, 21, 23–25, 32







HOW DOES THIS COOKTOP COMPARE TO YOUR OLD ONE?

Your new cooktop has gas burners. If you are used to cooking with induction or other electric surface units, you will notice some differences when you use gas burners.

The best types of cookware to use, plus heat-up and cool-down times, depend upon the type of burner or surface unit you have.

The following chart will help you to understand the differences between gas burner cooktops and any other type of cooktop you may have used in the past.

Type of Cooktop	Description	How it Works
Gas Burners 	Regular or sealed gas burners.	Flames heat the pans directly. Pan flatness is not critical to cooking results, but flat-bottomed pans provide more stability on top of the grates. Gas burners heat the pan right away and change heat settings right away. When you turn the control off, cooking stops right away.
Radiant (Glass Ceramic) Cooktop 	Electric coils under a glass-ceramic cooktop.	Heat travels to the glass surface and then to the cookware, so pans must be flat on the bottom for good cooking results. The glass cooktop stays hot enough to continue cooking after it is turned off. Remove the pan from the surface unit if you want cooking to stop.
Induction 	High frequency induction coils under a glass surface.	Pans must be made of ferrous metals (metal that attracts a magnet). Heat is produced by a magnetic circuit between the coil and the pan. Heats up right away and changes heat settings right away, like a gas cooktop. After turning the control off, the glass cooktop is hot from the heat of the pan, but cooking stops right away.
Electric Coil 	Flattened metal tubing containing electric resistance wire suspended over a drip pan.	Heats by direct contact with the pan and by heating the air under the pan. For best cooking results, use good quality pans. Electric coils are more forgiving of warped pans than radiant or solid disks. Heats up quickly but does not change heat settings as quickly as gas or induction. Electric coils stay hot enough to continue cooking for a short time after they are turned off.
Solid Disk 	Solid cast iron disk sealed to the cooktop surface.	Heats by direct contact with the pan, so pans must be flat on the bottom for good cooking results. Heats up and cools down more slowly than electric coils. The disk stays hot enough to continue cooking after it is turned off. Remove the pan from the solid disk if you want the cooking to stop.

SURFACE COOKING



Surface Burner Controls

The knobs that turn the surface burners on and off are located on the control panel in front of the burners.

The two knobs on the left control the left front and left rear burners. The two knobs on the right control the right front and right rear burners.

Before Lighting a Burner

- If drip pans are supplied with your range, they should be used at all times.
- Make sure all grates on the range are in place before using any burner.

On ranges with sealed burners:

- The smaller burner (right rear position) will give the best simmer results. It offers precise cooking performance for delicate foods, such as sauces or foods which need to cook over low heat for a long time. It can be turned down to a very low simmer setting.
- The right front burner is higher powered than the others and will bring liquids to a boil quicker.

To Light a Surface Burner

Push the control knob in and turn it to LITE. You will hear a little “clicking” noise—the sound of the electric spark igniting the burner.

Turn the knob to adjust the flame size. If the knob stays at LITE, it will continue to click.

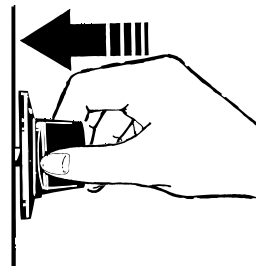

When one burner is turned to LITE, all the burners spark. Do not attempt to disassemble or clean around any burner while another burner is on. An electric shock may result, which could cause you to knock over hot cookware.

In case of a power failure, you can light the surface burners on your range with a match. Hold a lighted match to the burner, then turn the knob to the LITE position. **Use extreme caution when lighting burners this way.**

Surface burners in use when an electrical power failure occurs will continue to operate normally.

After Lighting a Burner

- Do not operate a burner for an extended period of time without cookware on the grate. The finish on the grate may chip without cookware to absorb the heat.
- Be sure the burners and grates are cool before you place your hand, a pot holder, cleaning cloths or other materials on them.

How to Select Flame Size

Watch the flame, not the knob, as you reduce heat.

The flame size on a gas burner should match the cookware you are using.

FOR SAFE HANDLING OF COOKWARE NEVER LET THE FLAME EXTEND UP THE SIDES OF THE COOKWARE.

Any flame larger than the bottom of the cookware is wasted and only serves to heat the handle.

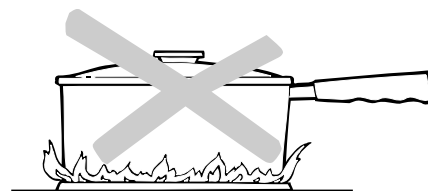

(continued next page)



SURFACE COOKING

(continued)

Top-of-Range Cookware

Aluminum: Medium-weight cookware is recommended because it heats quickly and evenly. Most foods brown evenly in an aluminum skillet. Use saucepans with tight-fitting lids when cooking with minimum amounts of water.

Cast-Iron: If heated slowly, most skillets will give satisfactory results.

Enamelware: Under some conditions, the enamel of some cookware may melt. Follow cookware manufacturer's recommendations for cooking methods.

Glass: There are two types of glass cookware—those for oven use only and those for top-of-range cooking (saucepans, coffee and teapots). Glass conducts heat very slowly.

Heatproof Glass Ceramic: Can be used for either surface or oven cooking. It conducts heat very slowly and cools very slowly. Check cookware manufacturer's directions to be sure it can be used on gas ranges.

Stainless Steel: This metal alone has poor heating properties and is usually combined with copper, aluminum or other metals for improved heat distribution. Combination metal skillets usually work satisfactorily if they are used with medium heat as the manufacturer recommends.

Stove Top Grills (on models with sealed burners)

Do not use stove top grills on your sealed gas burners. If you use the stove top grill on the sealed gas burner it will cause incomplete combustion and can result in exposure to carbon monoxide levels above allowable current standards. This can be hazardous to your health.

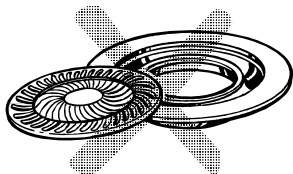

Wok This Way (on models with sealed burners)

We recommend that you use a flat-bottomed wok. They are available at your local retail store.



A traditional round bottom wok can be used with Wok Holder accessory, model JXWK which can be ordered from your appliance dealer. The Wok Holder fits on top of the range grate to provide support and proper air circulation for traditional round bottom woks only. Do not use flat bottomed woks with the Wok Holder.

Do not use a wok on any other support ring.

Placing the ring over the burner grate may cause the burner to work improperly, resulting in carbon monoxide levels above allowable current standards. This could be dangerous to your health. Do not try to use such woks without the ring unless you are using the Wok Holder. You could be seriously burned if the wok tipped over.

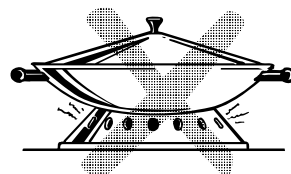

FEATURES OF YOUR OVEN CONTROL

(Features and appearance may vary)

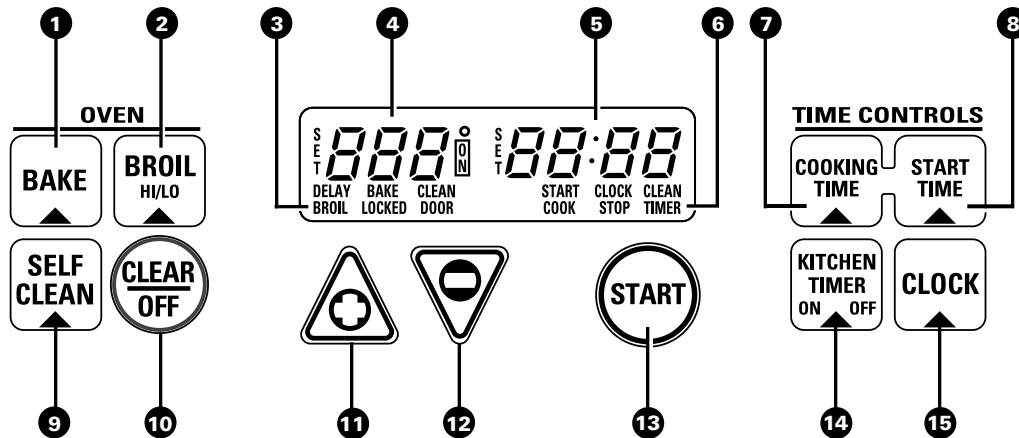

- 1. BAKE.** Press this pad to select the bake function.
- 2. BROIL HI/LO.** Press this pad to select the broil function.
- 3. FUNCTION INDICATORS.** Light up to show whether oven is in bake, broil or self-clean mode.
- 4. OVEN TEMPERATURE AND BROIL DISPLAY.** Shows the oven temperature or the broil setting selected.
- 5. TIME DISPLAY.** Shows the time of day, the times set for the timer or automatic oven operation.
- 6. PROGRAM STATUS.** Words light up in the display to indicate what is in the time display. Programmed information can be displayed at any time by touching the pad of the operation you want to see. For example, you can display the current time of day while the timer is counting down by pressing the CLOCK pad.
- 7. COOKING TIME.** Press this pad for Timed Baking operations.
- 8. START TIME.** Use this pad along with the COOKING TIME or SELF CLEAN pad to set the oven to start automatically at a time you select.
- 9. SELF CLEAN.** Press this pad to select self-cleaning function. See the Operating the Self-Cleaning Oven section.
- 10. CLEAR/OFF.** Press this pad to cancel all oven operations except clock and timer.
- 11. INCREASE (+).** Short taps to this pad increase the time or temperature by small amounts. Press and hold the pad to increase the time or temperature by larger amounts.
- 12. DECREASE (-).** Short taps to this pad decrease the time or temperature by small amounts. Press and hold the pad to decrease the time or temperature by larger amounts.
- 13. START.** Must be pressed to start any cooking or cleaning function.
- 14. KITCHEN TIMER ON/OFF.** Press this pad to select timer function. The timer does not control oven operations. The timer can time up to 9 hours and 55 minutes.
To set the timer, first press the KITCHEN TIMER ON/OFF pad. Then press the INCREASE (+) or DECREASE (-) pad to change the time.
To cancel the timer, press and hold the KITCHEN TIMER ON/OFF pad until the word "TIMER" disappears from the display.
- 15. CLOCK.** To set the clock, first press the CLOCK pad. Then press the INCREASE (+) or DECREASE (-) pad to change the time of day. Press the CLOCK pad to start.

If "F- and a number" flash in the display and the oven control signals, this indicates function error code. If the function error code appears during the self-cleaning cycle, check the oven door latch. The latch handle may have been moved, even if only slightly, from the latched position. Make sure the latch is moved to the right as far as it will go. Press the CLEAR/OFF pad. Allow the oven to cool for one hour. Put oven back into operation. If the function error code repeats, disconnect power to the range and call for service.



OVEN CONTROL, CLOCK AND TIMER

Clock

The clock must be set before the controls for the oven will work.

The time of day clock **cannot** be changed during Timed Baking. (It can be changed during a regular bake or broil operation.)

To Set the Clock



1. Press the CLOCK pad.



2. Press the + or - pad to set the time of day



3. Press the START pad. This enters the time and starts the clock.

To check the time of day when the display is showing other information, simply press the CLOCK pad. The time of day shows until another pad is pressed.

Timer

You may program the timer to time cooking or other household activities for up to 9 hours and 59 minutes.

The timer counts down in minutes, 1 minute at a time, until the last 60 seconds are reached, then the control will beep one time. The seconds will not be displayed until the last minute is reached.

When the timer reaches “:00,” the control will beep 3 times followed by one beep every 6 seconds until the KITCHEN TIMER ON/OFF pad is pressed.

If you would like to remove the signal that beeps every six seconds, press and hold the CLEAR/OFF pad for 10 seconds.

To return the signal that beeps every six seconds, press and hold the CLEAR/OFF pad for 10 seconds.

How to Set the Timer



1. Press the KITCHEN TIMER ON/OFF pad.

2. Press the + or – or pad to set the time.

If you make a mistake, press the KITCHEN TIMER ON/OFF pad and begin again.



3. Press the START pad. After pressing the START pad, “SET” disappears; this tells you the time is counting down, although the display does not change until one minute has passed.



4. When time is up, the oven control signals until you press the KITCHEN TIMER ON/OFF pad. Display then shows the time of day.

NOTE: The minute timer is independent of all the other functions and it does not control the oven. The CLEAR/OFF pad does not affect the timer.

Power Failure

If a flashing time is in the display, you have experienced a power failure. Reset the clock.

To reset the clock, press the CLOCK pad. Enter the correct time of day by pressing the + or – pad. Press the START pad.

OVEN CONTROL, CLOCK AND TIMER



The control has a series of tones that will sound at different times. These tones may sound while you set the control for an oven function or at the end of the oven function. They will also alert you when an incorrect time or temperature has been entered or if there is a problem with the oven.

Tones While Setting the Control

When you press a touch pad you will hear a beep. This beep will let you know you have placed enough pressure on the pad to activate it.

Preheat Notification Tone

When you set an oven temperature the oven automatically starts to heat. When the temperature inside the oven reaches your set temperature a tone will sound to let you know to place the food in the oven.

Attention Tone

This tone will sound if you set an invalid function or try to set an additional function. The tone can be quickly identified by watching the display messages.

USING YOUR OVEN

Before Using Your Oven

Be sure you understand how to set the controls properly. Practice removing and replacing the shelves while the oven is cool. Read the information and tips on the following pages. Keep this guide handy where you can refer to it, especially during the first weeks of using your new range.

Electric Ignition

Power Outage

CAUTION: Do not make any attempt to operate the electric ignition oven during an electrical power failure.

The oven or broiler cannot be lit during a power failure. Gas will not flow unless the glow bar is hot.

If the oven is in use when a power failure occurs, the oven burner shuts off and cannot be re-lit until power is restored. This is because the flow of gas is automatically stopped and will not resume when power is restored until the glow bar has reached operating temperature.

Oven Moisture

As your oven heats up, the temperature change of the air in the oven may cause water droplets to form on the door glass. These droplets are harmless and will evaporate as the oven continues to heat up.

Fluorescent Night Light (on some models)

Use the switch on the upper control panel to turn the light on and off.

Oven Light

Use the switch on the lower control panel to turn the light on or off.

Automatic Oven Shut Off

As a safety feature, this oven will automatically shut itself off if it has been left on for more than 12 hours.

(continued next page)



USING YOUR OVEN

(continued)

Oven Vents

The oven is vented through duct openings at the rear of the cooktop. See the Features section. Do not block these openings when cooking in the oven—it is important that the flow of hot air from the oven and fresh air to the oven burners be uninterrupted.

- **The vent openings and nearby surfaces may become hot. Do not touch them.**

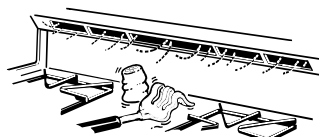

Vent appearance and location vary

- **Do not leave plastic items on the cooktop—they may melt if left too close to the vent.**

- **Handles of pots and pans on the cooktop may become hot if left too close to the vent.**
- **Metal items will become very hot if they are left on the cooktop and could cause burns.**
- **Do not leave any items on the cooktop.** The hot air from the vent may ignite flammable items and will increase pressure in closed containers, which may cause them to burst.

Oven Shelves

The shelves are designed with stop-locks so when placed correctly on the shelf supports, they will stop before coming completely out of the oven and will not tilt when you are removing food from them or placing food on them.

When placing cookware on a shelf, pull the shelf out to the bump on the shelf support. Place the cookware on the shelf, then slide the shelf back into the oven. This will eliminate reaching into the hot oven.

To remove a shelf from the oven, pull it toward you, tilt the front end upward and pull the shelf out.

To replace, place the shelf on the shelf support with the stop-locks (curved extension of the shelf) facing up and toward the rear of the oven. Tilt up the front and push the shelf toward the back of the oven until it goes past the bump on the shelf support. Then lower the front of the shelf and push it all the way back.

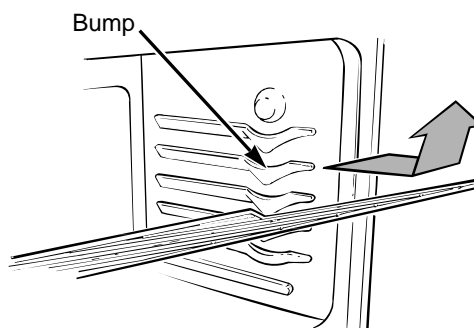

Shelf Positions

The oven has five shelf supports for baking, roasting and broiling identified in this illustration as A (bottom), B, C, D and E (top). It also has a special low shelf position (R) for roasting extra large items, such as a large turkey—the shelf is not designed to slide out at this position. Shelf positions for cooking are suggested in the Baking, Roasting and Broiling sections.

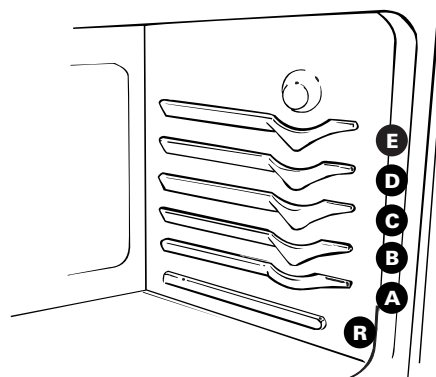

BAKING



Do not lock the oven door with the latch during baking. The latch is used for self-cleaning only.

Your oven temperature is controlled using the latest technology oven control systems. It is recommended that you operate your new oven for a number of weeks to become familiar with its performance.

If you think an adjustment is necessary, see the Adjust the Oven Thermostat section. It gives easy *Do It Yourself* instructions on how to adjust the thermostat.

How to Set Your Range for Baking

To avoid possible burns, place shelves in the correct position before you turn the oven on.

1. Press the BAKE pad.
2. Press the + or – pad until the desired temperature is displayed.

The oven will start automatically. The word “ON” and “100°” will be displayed. As the oven heats up, the display will show the changing temperature. When the oven reaches the temperature you set, a tone will sound.

3. Press the CLEAR/OFF pad when baking is finished and then remove the food from the oven.

To change the oven temperature during BAKE cycle, press the BAKE pad and then the + or – pad to get the new temperature.

Oven Shelves

Arrange the oven shelf or shelves in the desired locations while the oven is cool. The correct shelf position depends on the kind of food and the browning desired.

As a general rule, place most foods in the middle of the oven, on either shelf position B or C. See the chart for suggested shelf positions.

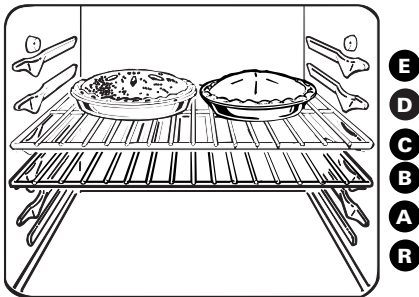

Type of Food	Shelf Position
Angel food cake	A
Biscuits or muffins	B or C
Cookies or cupcakes	B or C
Brownies	B or C
Layer cakes	B or C
Bundt or pound cakes	A or B
Pies or pie shells	B or C
Frozen pies	A (on cookie sheet)
Casseroles	B or C
Roasting	B or R

(continued next page)



BAKING

(continued)

Preheating

Preheat the oven if the recipe calls for it. Preheat means bringing the oven up to the specified temperature before putting the food in the oven. To preheat, set the oven at the correct temperature—selecting a higher temperature does not shorten preheat time.

Preheating is necessary for good results when baking cakes, cookies, pastry and breads. For most casseroles and roasts, preheating is not necessary. For ovens without a preheat indicator light or tone, preheat 10 minutes. After the oven is preheated place the food in the oven as quickly as possible to prevent heat from escaping.

Pan Placement

For even cooking and proper browning, there must be enough room for air circulation in the oven. Baking results will be better if baking pans are centered as much as possible rather than being placed to the front or to the back of the oven.

Pans should not touch each other or the walls of the oven. Allow 2 to 4 cm (1 to 1½") space between pans as well as from the back of the oven, the door and the sides. If you need to use two shelves, stagger the pans so one is not directly above the other.

Baking Guides

When using prepared baking mixes, follow package recipe or instructions for best baking results.

Cookies

When baking cookies, flat cookie sheets (without sides) produce better-looking cookies. Cookies baked in a jelly roll pan (short sides all around) may have darker edges and pale or light browning may occur.

Cookies can be baked on several shelves at the same time but browning may be uneven because of reduced air circulation.

Do not use a cookie sheet so large that it touches the walls or the door of the oven.

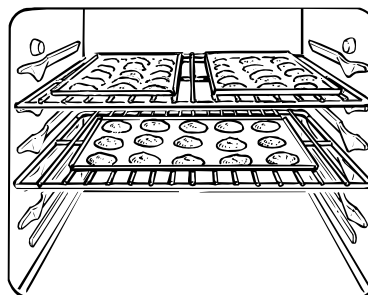

Aluminum Foil

Never entirely cover a shelf with aluminum foil. This will disturb the heat circulation and result in poor baking. A smaller sheet of foil may be used to catch a spillover by placing it on a lower shelf several centimeters below the food.

Do not put aluminum foil on the oven bottom.

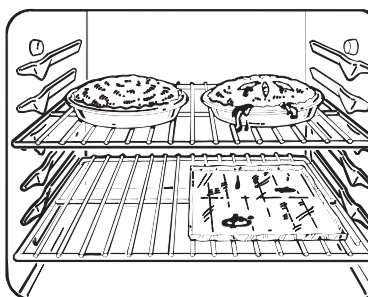

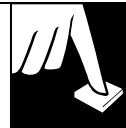

Pies

For best results, bake pies in dark, rough or dull pans to produce a browner, crisper crust. Stagger the pies for most even browning. Frozen pies in foil pans should be placed on an aluminum cookie sheet for baking since the shiny foil pan reflects heat away from the pie crust; the cookie sheet helps retain it.

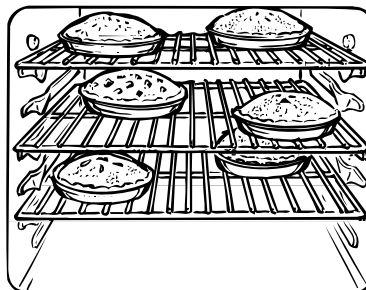

Cakes

For best browning when baking several 20.3 cm or 22.9 cm (8" or 9") cakes, stagger them so one pan is not directly above another. Warped or bent pans will cause uneven baking results and poorly shaped products. A cake baked in a pan larger than the recipe recommends will usually be crisper, thinner and drier than it should be. If baked in a pan smaller than recommended, it may be undercooked and batter may overflow.

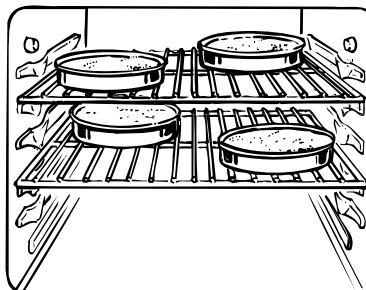

Baking Pans

Use the proper baking pan. The type of finish on the pan determines the amount of browning that will occur.

- Dark, rough or dull pans absorb heat resulting in a browner, crisper crust. Use this type for pies.
- Shiny, bright and smooth pans reflect heat, resulting in a lighter, more delicate browning. Cakes and cookies require this type of pan.

- Glass baking dishes also absorb heat. When baking in glass baking dishes, the temperature may need to be reduced by 12°C. (25°F.).
- If you are using dark non-stick pans, you may find that you need to reduce the oven temperature 12°C. (25°F.) to prevent over-browning.

Don't Peek

Set the timer for the estimated cooking time and do not open the door to look at your food. Most recipes provide minimum and maximum baking times such as "bake 30-40 minutes."

DO NOT open the door to check until the minimum time. Opening the oven door frequently during cooking allows heat to escape and makes baking times longer. Your baking results may also be affected.



TIMED BAKING

How to Time Bake

Do not lock the oven door with the latch during Timed Baking. The latch is used for self-cleaning only.

The oven control allows you to turn the oven on or off automatically at specific times that you set.

NOTE: Before beginning make sure the clock shows the correct time of day.

To set the clock, first press the CLOCK pad. Press the + or – pad until the correct time of day is displayed. Press the CLOCK pad to start.

How to Set Immediate Start and Automatic Stop

To avoid possible burns, place the shelves in the correct position before you turn the oven on.

The oven will turn on immediately and cook for a selected length of time. At the end of Cooking Time, the oven will turn off automatically.



1. Press the BAKE pad.

2. Press the + or – pad to set the oven temperature.



3. Press the COOKING TIME pad.

4. Press the + or – pad to set the baking time.

The oven temperature and the cooking time that you entered will be displayed.



5. Press the START pad. The display shows the oven temperature that you set and the cooking time countdown. [The display starts changing once the temperature reaches 43°C. (100°F.)]

The oven will continue to cook for the programmed amount of time, then shut off automatically.



6. Press the CLEAR/OFF pad to clear the display if necessary. Remove the food from the oven. Remember, even though the oven shuts off automatically, foods continue cooking after the controls are off.

NOTE: Foods that spoil easily, such as milk, eggs, fish, stuffings, poultry and pork, should not be allowed to sit for more than one hour before or after cooking. Room temperature promotes the growth of harmful bacteria. Be sure that the oven light is off because heat from the bulb will speed harmful bacteria growth.

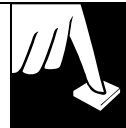

How to Set Delay Start and Automatic Stop

Quick Reminder:

1. Press the BAKE pad.
2. Press the + or – pad to select oven temperature.
3. Press the COOKING TIME pad.
4. Press the + or – pad to set the length of baking time.
5. Press the START TIME pad.
6. Press the + or – pad to set the desired start time.
7. Press the START pad.

To avoid possible burns, place the shelves in the correct position before you turn the oven on.

You can set the control to delay-start the oven, cook for a specific length of time and then turn off automatically.



1. Press the BAKE pad.

2. Press the + or – pad to set the temperature.



3. Press the COOKING TIME pad.

4. Press the + or – pad to set the baking time.

5. Press the START TIME pad.



6. Press the + or – or number pads to set the time of day you want the oven to turn on and start cooking.



7. Press the START pad.



If you would like to check the times you have set, press the START TIME pad to check the start time you have set or press the COOKING TIME pad to check the length of cooking time you have set.

When the oven turns on at the time of day you have set, the display will show the changing temperature [starting at 43°C. (100°F.)] and the cooking time countdown.

At the end of cooking time the oven will turn off and the end of cycle tone will sound.



8. Press the CLEAR/OFF pad to clear the end of cycle tone if necessary. Remove the food from the oven. Remember, even though the oven shuts off automatically, foods continue cooking after the controls are off.

NOTE:

- The low temperature zone of this range [between 65°C. and 93°C. (150°F. and 200°F.)] is available to keep hot cooked foods warm. Food kept in the oven longer than two hours at these low temperatures may spoil.
- Foods that spoil easily, such as milk, eggs, fish, stuffings, poultry and pork, should not be allowed to sit for more than one hour before or after cooking. Room temperature promotes the growth of harmful bacteria. Be sure the oven light is off because heat from the bulb will speed harmful bacteria growth.



ADJUST THE OVEN THERMOSTAT— *DO IT YOURSELF!*

You may find that your new oven cooks differently than the one it replaced. We recommend that you use your new oven for a few weeks to become more familiar with it, following the times given in your recipes as a guide.

If you think your new oven is too hot or too cold, you can adjust the thermostat yourself. If you think it is too hot, adjust the thermostat to make it cooler. If you think it is too cool, adjust the thermostat to make it hotter.

We do not recommend the use of thermometers, such as those found in grocery stores, to check the temperature setting of your new oven. These thermometers may vary 11–22°C. (20–40°F.).

To Adjust the Thermostat



1. Press the BAKE and BROIL HI/LO pads at the same time for 2 seconds until the display shows “SF.”

2. Press the BAKE pad. A two digit number shows in the display.



3. The oven temperature can be adjusted up to (+) 20°C. (35°F.) hotter or (–) 20°C. (35°F.) cooler. Press the + pad to increase the temperature in 1 degree increments.

Press the – pad to decrease the temperature in 1 degree increments.



4. When you have made the adjustment, press the START pad to go back to the time of day display. Use your oven as you would normally.

NOTE: This adjustment will not affect the broiling or self-cleaning temperatures. It will be retained in memory after a power failure.

The Type of Margarine Will Affect Baking Performance

Most recipes for baking have been developed using high fat products such as butter or margarine (80% fat). If you decrease the fat, the recipe may not give the same results as with a higher fat product.

Recipe failure can result if cakes, pies, pastries, cookies or candies are made with low fat spreads. The lower the fat content of a spread product, the more noticeable these differences become.

Federal standards require products labeled “margarine” to contain at least 80% fat by weight. Low fat spreads, on the other hand, contain less fat and more water. The high moisture content of these spreads affect the texture and flavor of baked goods. For best results with your old favorite recipes, use margarine, butter or stick spreads containing at least 70% vegetable oil.

ROASTING

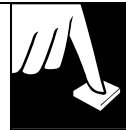

Do not lock the oven door with the door latch during roasting. This is used for self-cleaning only.

Roasting is cooking by dry heat. Tender meat or poultry can be roasted uncovered in your oven. Roasting temperatures, which should be low and steady, keep spattering to a minimum.

The oven has a special low shelf (R) position just above the oven bottom. Use it when extra cooking space is needed, for example, when roasting a large turkey. The shelf is not designed to slide out at this position.



Roasting is really a baking procedure used for meats. Therefore, oven controls are set for Baking or Timed Baking. (You may hear a slight clicking sound, indicating the oven is working properly.) Timed Baking will turn the oven on and off automatically.

Most meats continue to cook slightly while standing, after being removed from the oven. The standing time recommended for roasts is 10 to 20 minutes. This allows roasts to firm up and makes them easier to carve. The internal temperature will rise about 3°C. to 8°C. (5° to 10°F.); to compensate for the temperature rise, if desired, remove the roast from oven sooner [3°C. to 8°C. (5° to 10°F.) less than the temperature in the Roasting Guide].

Remember that food will continue to cook in the hot oven and therefore should be removed when the desired internal temperature has been reached.

1. Position the oven at shelf (B) position for small size roast [1.3 to 2.3 kg (3 to 5 lbs.)] and at (R) position for larger roasts.

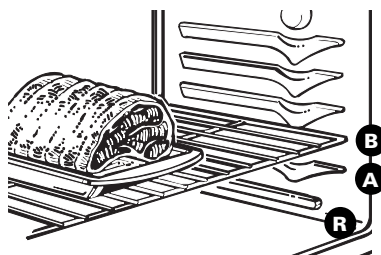

2. Check the weight of the meat. Place the meat fat-side-up, or poultry breast-side-up, on roasting grid in a shallow pan. The melting fat will baste the meat. Select a pan as close to the size of the meat as possible. (The broiler pan with grid is a good pan for this.)



3. Press the BAKE pad.

4. Press the + or – pad until the desired temperature is displayed.

The oven will start automatically. The word “ON” and “100°” will be displayed. As the oven heats up, the display will show the changing temperature. When the oven reaches the temperature you set, a tone will sound.



5. Press the CLEAR/OFF pad when roasting is finished and then remove the food from the oven.

To change the oven temperature during the roasting cycle, press the BAKE pad and then the + or – pad to get the new temperature.

Use of Aluminum Foil

You can use aluminum foil to line the broiler pan. This makes clean-up easier when using the pan for marinating, cooking with fruits, cooking heavily cured meats or basting food during cooking. Press the foil tightly around the inside of the pan.

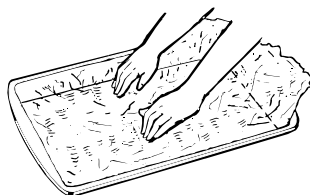

Dual Shelf Cooking

This allows more than one food to be cooked at the same time. For example: While roasting a 10 kg (20-lb.) turkey on shelf (R), a second shelf may be added on position D so that an additional food such as scalloped potatoes can be cooked at the same time. Foods cooked with the turkey should be added toward the end of the time allowed for the turkey. For example, potatoes which cook for 1 hour should be added to the oven 1 hour before the end of cooking time for the turkey.

(continued next page)



ROASTING

(continued)

Questions

Q. Is it necessary to check for doneness with a meat thermometer?

A. Checking the finished internal temperature at the completion of cooking time is recommended. Temperatures are shown in Roasting Guide. For roasts over 3.6 kg (8 lbs.), check with thermometer at half-hour intervals after half the time has passed.

Q. Why is my roast crumbling when I try to carve it?

A. Roasts are easier to slice if allowed to cool 10 to 20 minutes after removing from oven. Be sure to cut across the grain of the meat.

Q. Do I need to preheat my oven each time I cook a roast or poultry?

A. It is not necessary to preheat your oven.

Q. When buying a roast, are there any special tips that would help me cook it more evenly?

A. Yes. Buy a roast as even in thickness as possible, or buy rolled roasts.

Q. Can I seal the sides of my foil “tent” when roasting a turkey?

A. Sealing the foil will steam the meat. Leaving it unsealed allows the air to circulate and brown the meat.

ROASTING GUIDE

Frozen Roasts

Frozen roasts of beef, pork, lamb, etc., can be started without thawing, but allow 15 to 25 minutes per 450 grams (1 pound) additional time [15 minutes per 450 grams (1 pound) for roasts under 2.3 kg (5 lbs.), more time for larger roasts.]

Make sure poultry is thawed before roasting. Unthawed poultry often does not cook evenly. Some commercial frozen poultry can be cooked successfully without thawing. Follow directions given on package label.

Type	Oven Temperature	Doneness	Approximate Roasting Time in Minutes per 450 Grams (1 Pound)		Internal Temperature °C.
Meat			1.4 to 2.3 kg (3 to 5 lbs.)	2.7 to 3.6 kg (6 to 8 lbs.)	
Tender cuts; rib, high quality sirloin tip, rump or top round*	163°C. (325°F.)	Rare: Medium: Well Done:	24–35 35–39 39–45	18–25 25–31 31–33	60°–66° (140°–150°F.)† 66°–71° (150°–160°F.) 77°–85° (170°–185°F.)
Lamb leg or bone-in shoulder*	163°C. (325°F.)	Rare: Medium: Well Done:	21–25 25–30 30–35	20–23 24–28 28–33	60°–66° (140°–150°F.)† 66°–71° (150°–160°F.) 77°–85° (170°–185°F.)
Veal shoulder, leg or loin*	163°C. (325°F.)	Well Done:	35–45	30–40	77°–82° (170°–180°F.)
Pork loin, rib or shoulder*	163°C. (325°F.)	Well Done:	35–45	30–40	77°–82° (170°–180°F.)
Ham, precooked	163°C. (325°F.)	To Warm:	18–23 minutes per 450 grams (1 pound) (any weight)		46°–52° (115°–125°F.)
Poultry			1.4 to 2.3 kg (3 to 5 lbs.)	Over 2.3 kg (5 lbs.)	
Chicken or Duck	163°C. (325°F.)	Well Done:	35–40	30–35	85°–88° (185°–190°F.)
Chicken pieces	177°C. (350°F.)	Well Done:	35–40		85°–88° (185°–190°F.)
Turkey	163°C. (325°F.)	Well Done:	4.5 to 6.8 kg (10 to 15 lbs.) 16–22	Over 6.8 kg (15 lbs.) 12–19	In thigh: 85°–88° (185°–190°F.)

*For boneless rolled roasts over 15 cm (6") thick, add 5 to 10 minutes per 450 grams (1 pound) to times given above.

†The U.S. Department of Agriculture says “Rare beef is popular, but you should know that cooking it to only 60°C. (140°F.) means some food poisoning organisms may survive.” (Source: Safe Food Book. Your Kitchen Guide. USDA Rev. June 1985.)

BROILING



Do not lock the oven door with the latch during broiling. The latch is used for self-cleaning only.

Broiling is cooking food by direct heat from above the food. Most fish and tender cuts of meat can be broiled. Follow these directions to keep spattering and smoking to a minimum.

The oven door must be *closed* during broiling.

Turn the food only once during broiling. Time the foods for the first side according to the Broiling Guide. Turn the food, then use the times given for the second side as a guide to the preferred doneness.

1. If the meat has fat or gristle around the edge, cut vertical slashes through both about 5 cm (2") apart. If desired, the fat may be trimmed, leaving layer about 3 mm (1/8") thick.
2. Place the meat on the broiler grid on the broiler pan which comes with the range. Always use the grid so the fat drips into the broiler pan; otherwise the juices may become hot enough to catch on fire.
3. Position the shelf on the recommended shelf position as suggested in the Broiling Guide.
4. **Close the oven door.**



5. Press the BROIL HI/LO pad.

6. Press the BROIL HI/LO pad again (alternates between LO Broil and HI Broil).



7. Press the START pad.



8. When broiling is completed, press the CLEAR/OFF pad. Serve the food immediately, and leave the pan outside the oven to cool during the meal for easiest cleaning.

Use of Aluminum Foil

You can use aluminum foil to line your broiler pan and broiler grid. However, you must mold the foil tightly to the grid and cut slits in it just like the grid.

Without the slits, the foil will prevent fat and meat juices from draining to the broiler pan. The juices could become hot enough to catch on fire. If you do not cut the slits, you are frying, not broiling.

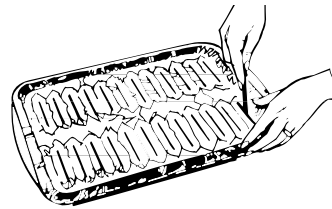

Questions and Answers

Q. When broiling, is it necessary to always use a grid in the pan?

A. Yes. Using the grid suspends the meat over the pan. As the meat cooks, the juices fall into the pan, thus keeping meat drier. Juices are protected by the grid and stay cooler, thus preventing excessive spatter and smoking.

Q. Should I salt the meat before broiling?

A. No. Salt draws out the juices and allows them to evaporate. Always salt after cooking. Turn the meat with tongs; piercing the meat with a fork also allows the juices to escape. When broiling poultry or fish, brush each side often with butter.

Q. Why are my meats not turning out as brown as they should?

A. Check to see if you are using the recommended shelf position. Broil for the longest period of time indicated in the Broiling Guide. Turn the food only once during broiling.



BROILING GUIDE

The oven door must be *closed* during broiling.

- Always use the broiler pan and grid that comes with your range. It is designed to minimize smoking and spattering by trapping juices in the shielded lower part of the pan.
- For steaks and chops, slash the fat evenly around the outside edges of the meat. To slash, cut crosswise through the outer fat surface just to the edge of the meat. Use tongs to turn the meat over to prevent piercing the meat and losing the juices.
- Use LO Broil to cook foods such as poultry or thick pork chops thoroughly without over browning them.
- If desired, marinate meats or chicken before broiling. Or brush with barbecue sauce last 5 to 10 minutes only.
- When arranging food on the pan, do not let fatty edges hang over the sides because dripping fat could soil the oven.
- The broiler compartment does not need to be preheated. However, for very thin foods, or to increase browning, preheat if desired.
- Frozen steaks can be broiled by positioning the shelf at next lowest shelf position and increasing cooking time given in this guide 1½ times per side.

Food	Quantity and/or Thickness	Shelf Position	1st Side Minutes	2nd Side Minutes	Comments
Bacon	227 g (1/2 lb.) (about 8 thin slices)	C	4	3	Arrange in single layer.
Ground Beef	450 g (1 lb.) (4 patties) 13–19 mm (1/2–3/4") thick	D	10–11	7	Space evenly. Up to 8 patties take about same time.
Beef Steaks					
Rare	2.5 cm (1") thick	C	9	7	Steaks less than 2.5 cm (1") thick will cook through before browning. Slash fat.
Medium	[450–680 g	C	12	5–6	
Well Done	(1–1½ lbs.)]	C	13	8–9	
Rare	3.8 cm (1½") thick	C	10	6–7	
Medium	[907 g–1.13kg	C	12–15	10–12	
Well Done	(2–2½ lbs.)]	C	25	16–18	
Chicken	1 whole [907 g–1.13kg (2–2½ lbs.)], split lengthwise Bone-in, 4 bone in breasts	B B	30–35 25–30	15–20 10–15	Brush each side with melted butter. Broil skin-side-down first.
Bakery Products					
Bread (Toast) or Toaster Pastries	2 to 4 slices 1 pkg. (2)	D	2–3	1/2–1	Space evenly. Place English muffins cut-side-up and brush with butter if desired.
English Muffins	2, split	D	3–5		
Lobster Tails	2 to 4 170–227 g (6–8 oz.) each	C	13–16	Do not turn over.	Cut through back of shell and spread open. Brush with melted butter before broiling and after half of time.
Fish	450 g (1-lb.) fillets 6–13 mm (1/4–1/2") thick	D	6	6	Handle and turn very carefully. Brush with lemon butter before broiling and during broiling if desired. Preheat broiler to increase browning.
Ham Slices	2.5 cm (1") thick	C	8	8	
Precooked	13 mm (1/2") thick	D	6	6	
Pork Chops	2 [13 mm (1/2") thick]	D	10	8	Slash fat.
Well Done	2 [2.5 cm (1") thick], about 450 g (1 lb.)	D	15	8	
Lamb Chops					
Medium	2 [2.5 cm (1") thick], about	D	8	4–7	Slash fat.
Well Done	284–340 g (10–12 oz.)	D	10	10	
Medium	2 [3.8 cm (1½") thick],	D	10	4–6	
Well Done	about 450 g (1 lb.)	D	17	12–14	
Wieners similar precooked sausages, bratwurst	450 g (1-lb.) pkg. (10)	D	6	1–2	If desired, split sausages in half lengthwise; cut into 13–15 cm (5–6") pieces.

OPERATING THE SELF-CLEANING OVEN

Normal Cleaning Time: 4 hours



Before a Clean Cycle

Quick Reminder:

1. Prepare the oven for cleaning.
2. Close and latch the oven door.
3. Press the SELF CLEAN pad.
4. Press the + or – pad.
5. Press the START pad.

If you wish to change the preset Clean Time of 4 hours, press the + or – pad until the desired Clean Time appears in the display.

We recommend venting with an open window or using a ventilation fan or hood during the first self-clean cycle.

1. Remove the broiler pan, broiler grid, all cookware and any aluminum foil from the oven—they cannot withstand the high cleaning temperatures.

NOTE: Take the shelves out of the oven before you begin the self-clean cycle.

2. Wipe up heavy soil on the oven bottom. If you use soap, **rinse thoroughly before self-cleaning to prevent staining.**

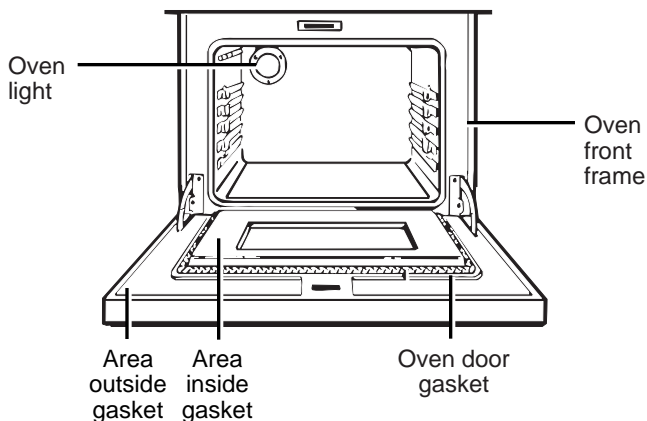

3. Clean spatters or spills on the oven front frame, and the oven door outside the gasket with a dampened cloth. The oven front frame and the oven door outside the gasket do not get cleaned by the self-clean cycle. On these areas use detergent and hot water or a soap-filled steel wool pad. Rinse well with a vinegar and water solution. This will help prevent a brown residue from forming when the oven is heated. Buff these areas with a dry cloth. Do not clean the gasket.

Clean the top, sides and outside front of the oven door with soap and water. Do not use abrasives or oven cleaners.

Make sure the oven light bulb cover is in place.

Do not rub or clean the door gasket—the fiberglass material of the gasket has an extremely low resistance to abrasion. An intact and well-fitting oven door gasket is essential for energy-efficient oven operation and good baking results. If you notice the gasket becoming worn, frayed or damaged in any way or if it has become displaced on the door, you should have it replaced.

4. Close the door and make sure the oven light is off. If the oven light is not turned off, the life of the bulb will be shortened or it may burn out immediately.

CAUTION: The grates and drip pans (on some models) should never be cleaned in the self-cleaning oven.

Do not use commercial oven cleaners or oven protectors in or near the self-cleaning oven. A combination of any of these products plus the high clean cycle temperatures may damage the porcelain finish of the oven.

IMPORTANT: The health of some birds is extremely sensitive to the fumes given off during the self-cleaning cycle of any oven. Move birds to another well ventilated room.

(continued next page)



OPERATING THE SELF-CLEANING OVEN

(continued)

How to Set the Oven for Cleaning

Quick Reminder:

1. Prepare the oven for cleaning.
2. Close and latch the oven door.
3. Press the SELF CLEAN pad.
4. Press the + or – pad.
5. Press the START pad.

If you wish to change the preset Clean Time of 4 hours, press the + or – pad until the desired Clean Time appears in the display.

1. Follow the directions in the Before a Clean Cycle section.

2. Close the oven door and slide the latch handle to the right as far as it will go.

Never force the door latch handle. Forcing the handle may damage the door lock mechanism.

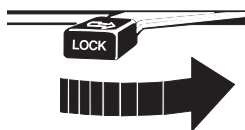

3. Press the SELF CLEAN pad.

4. Press the + or – pad until the desired Clean Time is displayed.

The Clean Time is normally 4 hours. You can change the Clean Time to any time between 3 and 5 hours, depending on the amount of soil in your oven.

5. Press the START pad.

The self-clean cycle will automatically begin after “CLEAN” is displayed and the word “ON” appears in the display. When the oven heats to a high temperature, the words “LOCKED DOOR” will be displayed and a short time later, the door will be locked in position. It will not be possible to open the oven door until the LOCKED DOOR light goes off and the oven has cooled below locking temperature.

6. When the LOCKED DOOR light is off, slide the latch handle to the left as far as it will go and open the door.

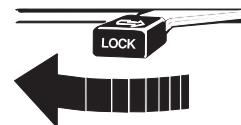

To Stop a Clean Cycle

Press the CLEAR/OFF pad. This will stop the cleaning cycle but you will not be able to open the door until the oven cools below the locking temperature.

After a Clean Cycle

When the clean cycle is finished, the word “CLEAN” will go out in the display. When the oven has cooled, the words “LOCKED DOOR” will go out and the door can be opened.

After a clean cycle, you may notice some white ash in the oven. Just wipe it up with a damp cloth.

If white spots remain, remove them with a soap-filled steel wool pad. Be sure to rinse thoroughly with a vinegar and water mixture. These deposits are usually a salt residue that cannot be removed by the clean cycle.

If the oven is not clean after one clean cycle, the cycle may be repeated.

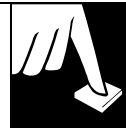

How to Delay Start of Cleaning

Delay Start is setting the oven timer to start the clean cycle automatically at a later time than the present time of day.

NOTE: Before beginning make sure the oven clock shows the correct time of day.

Quick Reminder—Delay Start for Self-Clean:

1. Prepare the oven for cleaning.
2. Close and latch the oven door.
3. Press the SELF CLEAN pad.
4. Press the + or – pad until the desired Clean Time appears.
5. Press the START TIME pad.
6. Press the + or – pad until the desired Start Time appears in the display.
7. Press the START pad.

1. Prepare the oven for cleaning.

2. Close the oven door and slide the latch handle to the right as far as it will go. Make sure the oven light is off.

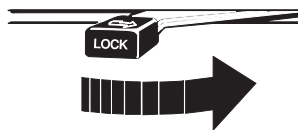

Never force the door latch handle. Forcing the handle may damage the door lock mechanism.



3. Press the SELF CLEAN pad.

4. Press the + or – pad to set the Clean Time.

5. The Clean Time is preset for 4 hours. You can change the Clean Time to any time between 3 and 5 hours, depending on the amount of soil in your oven. If a different Clean Time is desired, press the + or – pad until the desired Clean Time is displayed.



6. Press the START TIME pad.

7. Change the Start Time by pressing the + or – pad. The words “DELAY CLEAN” will appear in the display.

8. Press the START pad.



The self-clean cycle will automatically begin when the Start Time is reached. The word “ON” will appear in the display when the self-clean cycle begins.

When the oven locks, the words “LOCKED DOOR” will be displayed and a short time later the door will be locked in position. It will not be possible to open the oven door until the temperature drops below the lock temperature.

When the clean cycle is finished, the word “CLEAN” will go out in the display. When the oven has cooled, the words “LOCKED DOOR” will go out and the door can be opened.

9. When the LOCKED DOOR light is off, slide the latch handle to the left as far as it will go and open the door.

Never force the latch handle. Wait until the words “LOCKED DOOR” go out in the display. Forcing the latch handle may damage the lock.

(continued next page)



OPERATING THE SELF-CLEANING OVEN

(continued)

Questions and Answers

Q. If my oven clock is not set to the correct time of day, can I still self-clean my oven?

A. If the clock is not set to the correct time of day you will not be able to set a delay clean to end at a specific time.

Q. Can I use commercial oven cleaners on any part of my self-cleaning oven?

A. No cleaners or coatings should be used around any part of this oven. If you do use them and do not thoroughly rinse the oven with water, wiping it absolutely clean afterwards, the residue can scar the oven surface and damage metal parts the next time the oven is automatically cleaned.

Q. What should I do if excessive smoking occurs during cleaning?

A. This is caused by excessive soil. Press the CLEAR/OFF pad. Open the windows to rid the room of smoke. Wait until the oven has cooled and the word "LOCK" is off in the display. Wipe up the excess soil and reset the clean cycle.

Q. Is the "crackling" or "popping" sound I hear during cleaning normal?

A. Yes. This is the sound of the metal heating and cooling during both the cooking and cleaning functions.

Q. Should there be any odor during the cleaning?

A. Yes, there will be an odor during the first few cleanings. Failure to wipe out excessive soil might also cause a strong odor when cleaning.

Q. What causes the hair-like lines on the enameled surface of my oven?

A. This is a normal condition, resulting from heating and cooling during cleaning. These lines do not affect how your oven performs.

Q. Why do I have ash left in my oven after cleaning?

A. Some types of soil will leave a deposit which is ash. It can be removed with a damp sponge or cloth.

Q. Can I cook food on the cooktop while the oven is self-cleaning?

A. Yes. While the oven is self-cleaning, you can use the cooktop just as you normally do.

Q. The word "door" appeared in the display when I selected the Clean Cycle. What's wrong?

A. The door latch handle must be moved all the way to the right. Move the latch handle and cleaning will start.

CARE AND CLEANING

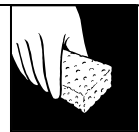

Proper care and cleaning are important so your range will give you efficient and satisfactory service. Follow these directions carefully in caring for it to help assure safe and proper maintenance.

BE SURE ELECTRICAL POWER IS DISCONNECTED BEFORE CLEANING ANY PART OF YOUR RANGE.

Sealed Burner Assemblies (on some models)

CAUTION: DO NOT OPERATE THE BURNER WITHOUT ALL BURNER PARTS AND DRIP PANS (IF SO EQUIPPED) IN PLACE.

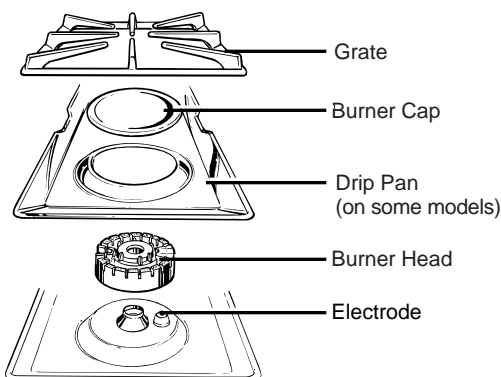

Turn all controls OFF before removing the burner parts and drip pans (if so equipped).

The burner grates, caps, burner heads and drip pans (if so equipped) can be lifted off, making them easy to clean.

The electrode of the spark igniter is exposed when the burner head is removed. When one burner is turned to LITE, all the burners spark. Do not attempt to disassemble or clean around any burner while another burner is on. An electric shock may result, which could cause you to knock over hot cookware.

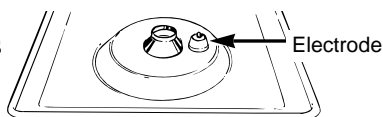

Burner Heads (on sealed burners only)

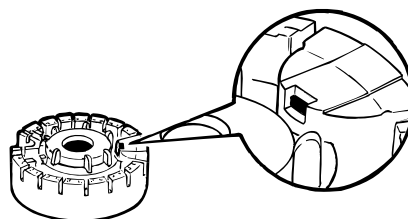

For proper ignition, make sure the small hole in the section that fits over the electrode is kept open. A sewing needle or wire twist tie works well to unclog it.

The slits in the burner heads of your range must be kept clean at all times for an even, unhampered flame.

You should clean the surface burners routinely, especially after bad spillovers, which could clog these openings.

To remove burned-on food, soak the burner heads in a solution of mild liquid detergent and hot water for 20-30 minutes. For more stubborn stains, use a toothbrush.

Before putting the burner head back, shake out excess water and then dry it thoroughly by setting it in a warm oven for 30 minutes.

Replace the burner caps. Make sure that caps are replaced on the correct size burner. There is one small, 2 medium and one large cap.

Burner Caps (on sealed burners only)

Lift off when cool. Wash burner caps in hot, soapy water and rinse with clean water. You may scour with a plastic scouring pad to remove burned-on food particles.

Dry them in a warm oven or with a cloth—don't reassemble them wet. Replace the burner caps.

Make sure that caps are replaced on the correct size burner. There is one small, 2 medium and one large cap.

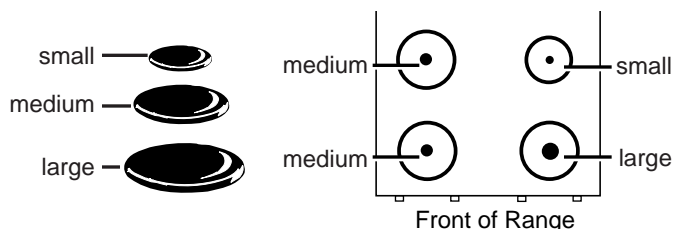

(continued next page)



CARE AND CLEANING

(continued)

Standard Twin Burners (on some models)

CAUTION: DO NOT OPERATE THE BURNER WITHOUT ALL BURNER PARTS AND DRIP PANS (IF SO EQUIPPED) IN PLACE.

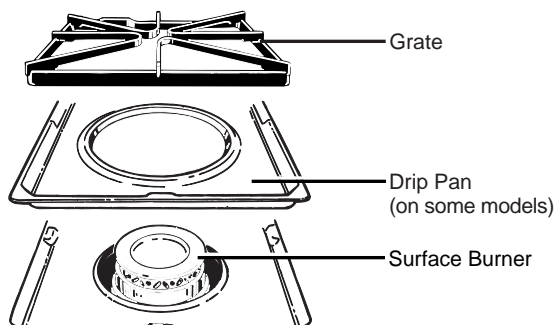

On models with standard twin burners, the cooktop lifts up for easy access.

Turn all controls OFF before removing burner parts and drip pans (if so equipped).

The burner grates and drip pans (if so equipped) can be lifted off, making them easy to clean.

The holes in the surface burners of your range must be kept clean at all times for proper ignition and an even, unhampered flame.

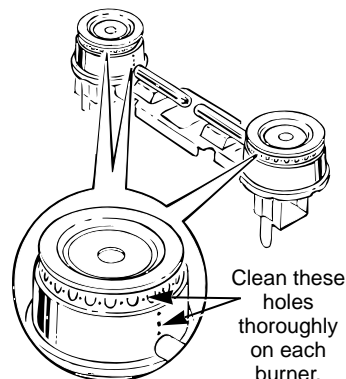

You should clean the surface burners routinely, especially after bad spillovers, which could clog these holes. Wipe off surface burners. If heavy spillover occurs, remove the surface burners from the range. Burners lift out for cleaning. Lift up the cooktop and then lift out the surface burners.

To remove burned-on food, soak the surface burner in a solution of mild liquid detergent and hot water. Soak the surface burner for 20 to 30 minutes. For more stubborn stains, use a cleanser like Soft Scrub® brand or Bon Ami® brand. **Rinse well to remove any traces of the cleanser that might clog the surface burner openings.** Do not use steel wool because it will clog the surface burner openings and scratch the surface burners. If the holes become clogged, clean them with a sewing needle or twist tie.

Before putting the surface burner back, shake out excess water and then dry it thoroughly by setting it in a warm oven for 30 minutes. Then place it back in the range, making sure it is properly seated and level.

Check the flame pattern of each burner. If the flames are “jumpy” (not steady), clean the holes again with a sewing needle or twist tie.

Drip Pans (on some models)

Remove the grates and lift out the drip pans.

Drip pans can be cleaned in dishwasher or by hand.

To get rid of burned-on food, place them in a covered container (or plastic bag) with 62 ml (1/4 cup) ammonia to loosen the soil. Then scrub with a soap-filled scouring pad if necessary.

When replacing the drip pans, make sure they are in the correct position.

CAUTION: Do not clean the drip pans in a self-cleaning oven.

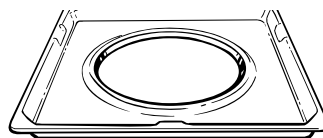

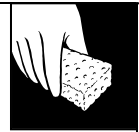

Burner Grates

Lift out when cool. Grates should be washed regularly and, of course, after spillovers. Wash them in hot, soapy water and rinse with clean water. After cleaning, dry them thoroughly by putting them in a warm oven for a few minutes. Don't put the grates back on the range while they are wet. When replacing the grates, be sure they're positioned securely over the burners.

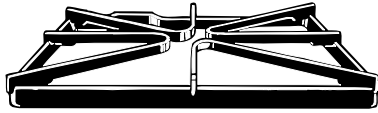

To prevent rusting on cast iron grates, apply a light coating of cooking oil on the bottom of the grates.

To get rid of burned-on food, place the grates in a covered container (or plastic bag) with 62 ml (1/4 cup) ammonia, for approximately 12 hours or overnight, to loosen the soil. Let sit overnight (or approximately 12 hours), then scrub with a soap-filled scouring pad if necessary. Rinse grates thoroughly and dry completely before replacing them on the range top.

Although they're durable, the grates will gradually lose their shine, regardless of the best care you can give them. This is due to their continual exposure to high temperatures. You will notice this sooner with lighter color grates.

Do not operate a burner for an extended period of time without cookware on the grate. The finish on the grate may chip without cookware to absorb the heat.

CAUTION: Do not clean the grates in a dishwasher or in a self-cleaning oven.

Cooktop Surface

To avoid damaging the porcelain enamel surface of the cooktop and to prevent it from becoming dull, clean up spills right away. Foods with a lot of acid (tomatoes, sauerkraut, fruit juices, etc.) or foods with high sugar content could cause a dull spot if allowed to set.

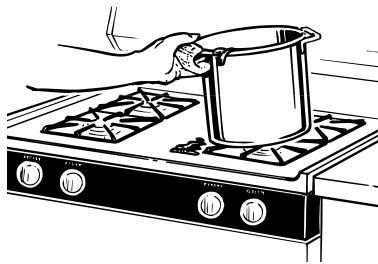

When the surface has cooled, wash and rinse. For other spills such as fat splatterings, etc., wash with soap and water once the surface has cooled. Then rinse and polish with a dry cloth.

Do not store flammable materials in an oven or near the cooktop. Do not store or use combustible materials, gasoline or other flammable vapors and liquids in the vicinity of this or any other appliance.

Oven Bottom

The oven bottom has a porcelain enamel finish. To make cleaning easier, protect the oven bottom from excessive spillovers by placing a cookie sheet on the shelf below the shelf you are cooking on. This is particularly important when baking a fruit pie or other foods with a high acid content.

We don't recommend using aluminum foil on the oven bottom. It can affect air flow if the holes are blocked and it can concentrate heat at the bottom of the oven, resulting in poor baking performance.

Hot fruit fillings or other foods that are highly acidic (such as tomatoes, sauerkraut, and sauces with vinegar or lemon juice) may cause pitting and damage to the porcelain enamel surface and should be wiped up immediately. To clean up spillovers, use soap and water, an abrasive cleaner or soap-filled steel wool pad. Rinse well to remove any soap before self-cleaning.

Brushed Chrome Cooktop (on some models)

Clean the brushed chrome top with warm, soapy water or Bon Ami® brand cleanser and immediately dry it with a clean, soft cloth. Take care to dry the surface following the "grain."

To help prevent finger marks after cleaning, spread a thin film of baby oil on the surface. Wipe away excess oil with a clean, soft cloth.



CARE AND CLEANING

(continued)

Lift-Off Oven Door

The oven door is removable, but it is heavy. You may need help removing and replacing the door.

To remove the door, open it a few inches to the special stop position that will hold the door open. Grasp firmly on each side and lift the door straight up and off the hinges.

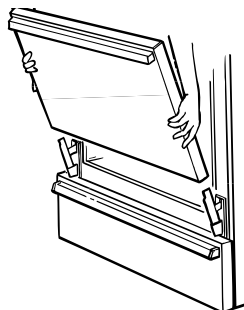

NOTE: Be careful not to place hands between the hinge and the oven door frame as the hinge could snap back and pinch fingers.

To replace the door, make sure the hinges are in the special stop position. Position the slots in the bottom of the door squarely over the hinges. Then lower the door slowly and evenly over both hinges at the same time. If the hinges snap back against the oven frame, pull them back out.

TO CLEAN THE DOOR:

(Do not immerse the door in water.)

Inside of the door:

- Because the area inside the gasket is cleaned during the self-clean cycle, you do not need to clean this by hand. Any soap left on the liner causes additional stains when the oven is heated.
- The area outside the gasket can be cleaned with a soap-filled steel wool or plastic pad.

- **Do not rub or clean the door gasket**—the fiberglass material of the gasket has an extremely low resistance to abrasion. An intact and well-fitting oven door gasket is essential for energy-efficient oven operation and good baking results. If you notice the gasket becoming worn, frayed or damaged in any way or if it has become displaced on the door, you should have it replaced.

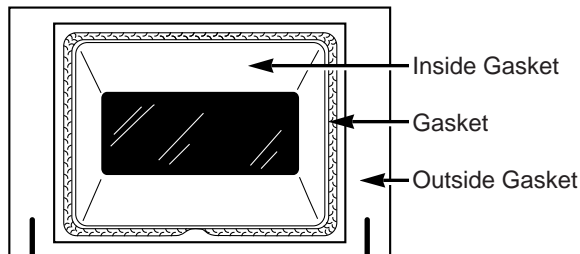

Outside of the door:

- Use soap and water to thoroughly clean the top, sides and front of the oven door. Rinse well. You may also use a glass cleaner to clean the glass on the outside of the door.
- Spillage of marinades, fruit juices, tomato sauces and basting materials containing acids may cause discoloration and should be wiped up immediately. When the surface is cool, clean and rinse.
- **Do not use oven cleaners, cleansing powders or harsh abrasives such as steel wool pads on the outside of the door.**

Broiler Pan and Grid

After broiling, remove the broiler pan from the oven. Remove the grid from the pan. Carefully pour out grease from the pan into a proper container. Wash and rinse the broiler pan and grid in hot water with a soap-filled or plastic scouring pad.

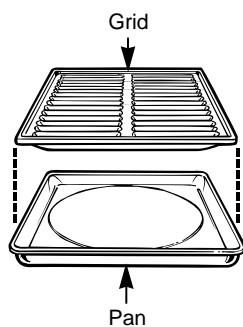

If food has burned on, sprinkle the grid with detergent while hot and cover with wet paper towels or a dishcloth. Soaking the pan will remove burned-on foods.

The broiler pan and grid may be cleaned with a commercial oven cleaner.

Both the broiler pan and grid can also be cleaned in a dishwasher.

Do not store a soiled broiler pan and grid anywhere in the range.

CAUTION: Do not clean the broiler pan or grid in a self-cleaning oven.

Oven Shelves

Clean the shelves with an abrasive cleanser or steel wool. After cleaning, rinse the shelves with clean water and dry with a clean cloth.

NOTE: Take the shelves out of the oven before you begin the self-clean cycle.

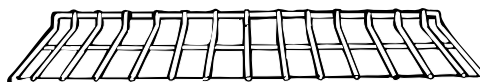

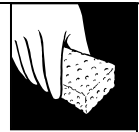

Oven Light Replacement (on some models)

CAUTION: Before replacing your oven light bulb, disconnect the electrical power to the range at the main fuse or circuit breaker panel. Be sure to let the light cover and bulb cool completely.

The oven light bulb is covered with a removable glass cover that is held in place with a bail-shaped wire. Remove the oven door, if desired, to reach cover easily.

To remove:

1. Hold a hand under the cover so it doesn't fall when released. With fingers of the same hand, firmly push back the wire cover holder. Lift off the cover.

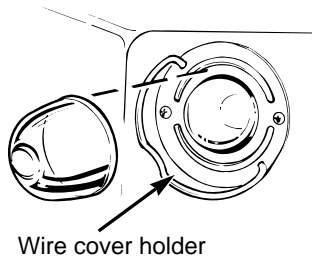

DO NOT REMOVE ANY SCREWS TO REMOVE COVER.

2. Do not touch hot bulb with a wet cloth. Replace bulb with a 40-watt household appliance bulb.

To replace cover:

1. Place it into the groove of the light receptacle. Pull the wire forward to the center of the cover until it snaps into place. When in place, the wire holds the cover firmly. Be certain the wire is in the depression in the center of the cover.
2. Connect electrical power to the range.

Control Panel and Knobs

It's a good idea to wipe the control panel after each use of the oven. Clean with mild soap and water or vinegar and water, rinse with clean water and polish dry with a soft cloth.

Do not use abrasive cleansers, strong liquid cleaners, plastic scouring pads or oven cleaners on the control panel—they will damage the finish. A 50/50 solution of vinegar and hot water works well.

The control knobs may be removed for easier cleaning. To remove a knob, pull it straight off the stem. If knob is difficult to remove, place a towel or dishcloth between the knob and control panel and pull gently. Wash the knobs in soap and water or a vinegar and hot water solution.

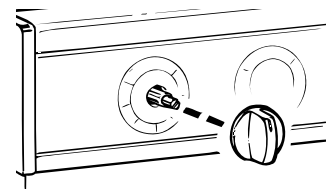

Metal parts can be cleaned with soap and water. Do not use steel wool, abrasives, ammonia, acids or commercial oven cleaner. Dry with a soft cloth.

Removable Storage Drawer (on some models)

The storage drawer is a good place to store cookware and bakeware. Do not store plastics and flammable material in the drawer.

The storage drawer may be removed for cleaning under the range. Clean the storage drawer with a damp cloth or sponge. Never use harsh abrasives or scouring pads.

To remove the storage drawer:

1. Pull the drawer straight out until it stops.
2. Tilt the front of the drawer up and free of the range.

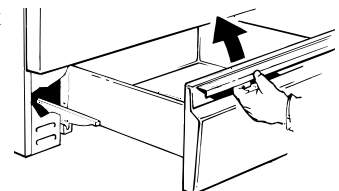

To replace the storage drawer:

1. Set the stops on the back of the drawer over the stops in the range.
2. Slide the drawer evenly and straight back, so that the rails in the range are engaged.

(continued next page)



CARE AND CLEANING

(continued)

Oven Air Vents

Never block the vents (air openings) of the range.

They provide the air inlet and outlet that are necessary for the range to operate properly with correct combustion. Air openings are located at the rear of the cooktop, at the top and bottom of the oven door, and at the bottom of the range, under the kick panel or storage drawer (depending on the model).

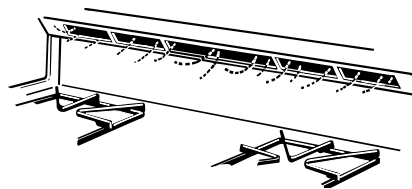

Vent appearance and location vary

Lift-up Cooktop (on models with standard twin burners)

Clean the area under the cooktop often. Built-up soil, especially grease, may catch on fire.

To make cleaning easier, the cooktop may be lifted up.

To raise the cooktop:

1. Be sure the burners are turned off.
2. Remove the grates.
3. Grasp the two front burner wells and lift up.

Some models have dual support rods that will hold the cooktop up while you clean underneath it.

After cleaning under the cooktop with hot, soapy water and a clean cloth, lower the cooktop. Be careful not to pinch your fingers.

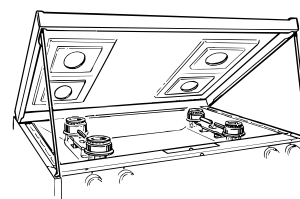

Removable Kick Panel (on some models)

The kick panel may be removed for cleaning under the range.

To remove, lift up the bottom of the panel slightly to disengage the panel from the tabs at the base of the range. Pull the bottom of the panel forward until the spring clips are released at the top of the panel.

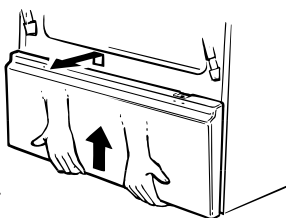

To replace, insert the two slots at the bottom of the panel onto the two tabs at the base of the range and push the top of the panel forward to engage the spring clips.

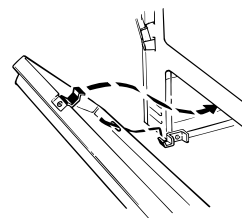

Fluorescent Night Light (on some models)

CAUTION: Do not touch the bulb with wet hands or when the bulb is hot. Never wipe the light area with a wet cloth. Electrical power must be shut off if you have to replace the bulb.

1. With a phillips screwdriver, remove the two screws.

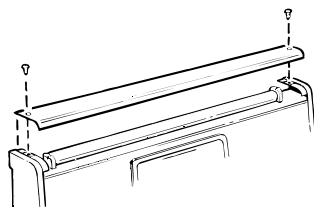

2. Lift canopy straight up.
3. Remove the fluorescent light bulb. Replace the bulb with one of the same length and wattage.
4. Replace the canopy.

INSTALLATION INSTRUCTIONS



FOR YOUR SAFETY

If you smell gas:

1. Open windows.
2. Don't touch electrical switches.
3. Extinguish any open flame.
4. Immediately call your gas supplier.

FOR YOUR SAFETY

Do not store or use combustible materials, gasoline or other flammable vapors and liquids in the vicinity of this or any other appliance.

BEFORE YOU BEGIN

Read these instructions completely and carefully.

IMPORTANT: Save these instructions for the local electrical inspector's use.

INSTALLER: Leave these instructions with the appliance after installation is completed.

CONSUMER: Keep this Use and Care Guide and the Installation Instructions for future use.

This appliance must be properly grounded.

WARNING

• Improper installation, adjustment, alteration, service or maintenance can cause injury or property damage. Refer to this guide. For assistance or additional information, consult a qualified installer, service agency, manufacturer (dealer) or the gas supplier.

• Never reuse old flexible connectors. The use of old flexible connectors can cause gas leaks and personal injury. Always use NEW flexible connectors when installing a gas appliance.

CAUTION

Do not attempt to operate the oven of this range during a power failure (electric ignition models only).

IMPORTANT

Remove all packing material and literature from oven before connecting gas and electrical supply to range.

DIMENSIONS AND CLEARANCES

Provide adequate clearances between the range and adjacent combustible surfaces.

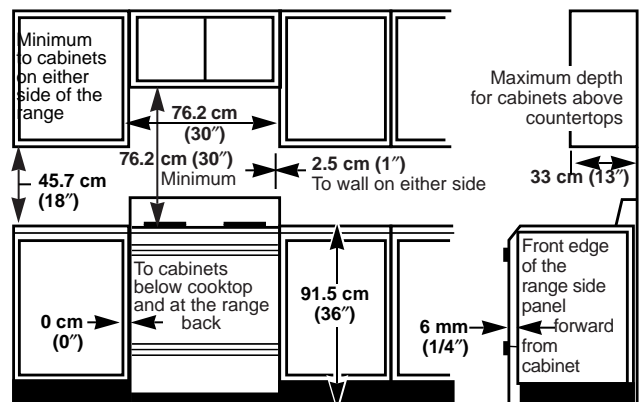
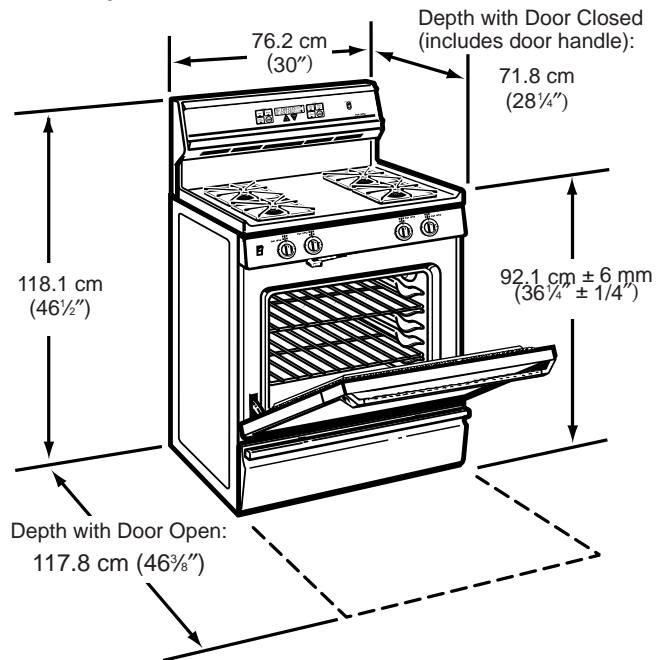

(continued next page)



INSTALLATION INSTRUCTIONS

(continued)

IMPORTANT SAFETY INSTRUCTIONS

Installation of this range must conform with local codes, or in the absence of local codes, with the National Fuel Gas Code, ANSI Z223.1, latest edition. In Canada, installation must conform with the current Natural Gas Installation Code, CAN/CGA-B149.1 or the current Propane Installation Code, CAN/CGA-B149.2, and with local codes where applicable.

This range has been design-certified by the American Gas Association according to ANSI Z21.1, latest edition and Canadian Gas Association according to CAN/CGA-1.1, latest edition. As with any appliance using gas and generating heat, there are certain safety precautions you should follow. You will find these precautions in the Important Safety Instructions in the front of this guide. Read them carefully.

- Have your range installed by a qualified installer or service technician.
- Your range must be electrically grounded in accordance with local codes or, in the absence of local codes, in accordance with the National Electrical Code (ANSI/NFPA 70, latest edition). In Canada, electrical grounding must be in accordance with the current CSA C22.1 Canadian Electrical Code Part 1 and/or local codes. See Electrical Connections in this section.
- Before installing your range on linoleum or any other synthetic floor covering, make sure the floor covering can withstand 82°C. (180°F) without shrinking, warping or discoloring. Do not install the range over carpeting unless a sheet of 6 mm (1/4") thick plywood or similar insulator is placed between the range and carpeting.
- Make sure the wall coverings around the range can withstand heat generated by the range up to 93°C. (200°F).
- Avoid placing cabinets above the range. To reduce the hazard caused by reaching over the open flames of operating burners, install a ventilation hood over the range that projects forward at least 12.7 cm (5") beyond the front of the cabinets.
- The ventilating hood must be constructed of sheet metal not less than .31 mm (0.0122") thick. Install above the cooktop with a clearance of not less than 6 mm (1/4") between the hood and the underside of the combustible material or metal cabinet. The hood must be at least as wide as the appliance and centered over the appliance. Clearance between the cooking surface and the ventilation hood surface **MUST NEVER BE LESS THAN 61 cm (24")**.

EXCEPTION: Installation of a listed microwave oven or cooking appliance over the cooktop shall conform to the installation instructions packed with that appliance.

- If cabinets are placed above the range, allow a minimum clearance of 76.2 cm (30") between the cooking surface and the bottom of unprotected cabinets.
- If a 76.2 cm (30") clearance between cooking surface and overhead combustible material or metal cabinets cannot be maintained, protect the underside of the cabinets above the cooktop with not less than 6 mm (1/4") insulating millboard covered with sheet metal not less than .31 mm (0.0122") thick.
- Clearance between the cooking surface and protected cabinets **MUST NEVER BE LESS THAN 61 cm (24")**. The vertical distance from the plane of the cooking surface to the bottom of adjacent overhead cabinets extending closer than 2.5 cm (1") to the plane of the range sides must not be less than 45.7 cm (18"). (See Dimensions and Clearances illustration in this section.)
- **CAUTION:** Items of interest to children should not be stored in cabinets above a range or on the backsplash of a range—children climbing on the range to reach items could be seriously injured.



WARNING

All ranges can tip and injury could result. To prevent accidental tipping of the range, attach an approved Anti-Tip device to the wall. (See Installing the Anti-Tip Device in this section.) To check if the device is installed and engaged properly, carefully tip the range forward. The Anti-Tip device



should engage and prevent the range from tipping over.

If you pull the range out from the wall for any reason, make sure the Anti-Tip device is engaged when you push the range back against the wall.

- For your safety, never use your range for warming or heating the room. Your oven and cooktop are not designed to heat your kitchen. Top burners should not be operated without cookware on the grate. Such abuse could result in fire and damage to your range and will void your warranty.
- Do not store or use combustible materials, gasoline or other flammable vapors and liquids in the vicinity of this or any other appliance. Explosions or fires could result.
- Do not use oven for a storage area. Items stored in the oven can ignite.
- Do not let cooking grease or other flammable materials accumulate in or near the range.



GENERAL

- See Dimensions and Clearances in this section for all rough-in and spacing dimensions. These dimensions must be met for safe use of your range. The location of the electrical outlet and pipe opening (see Gas Pipe and Electric Outlet Locations) may be adjusted to meet specific requirements.
- The range may be placed with 0 cm (0") clearance (flush) at the back wall and side walls of the range.

LOCATION

Do not locate the range where it may be subject to strong drafts. Any openings in the floor or wall behind the range should be sealed. Make sure the openings around the base of the range that supply fresh air for combustion and ventilation are not obstructed by carpeting or woodwork.

PROTECT YOUR FLOOR

Your range, like many other household items, is heavy and can settle into soft floor coverings such as cushioned vinyl or carpeting. Use care when moving the range on this type of flooring. It is recommended that the following simple and inexpensive instructions be followed to protect your floor.

The range should be installed on a sheet of plywood (or similar material). *When the floor covering ends at the front of the range*, the area that the range will rest on should be built up with plywood to the same level or higher than the floor covering. This will allow the range to be moved for cleaning or servicing. Also, make sure your floor covering will withstand 82°C. (180°F). (See the Important Safety Instructions section of the Installation Instructions.)

KITCHEN CABINETS

Make sure the wall coverings around your range can withstand the heat generated [up to 93°C. (200°F.)] by the range. (See the Important Safety Instructions section of the Installation Instructions.)

MODEL AND SERIAL NUMBER LOCATION

Depending on your range, you'll find the model and serial numbers on a label on the front frame of the range, behind the storage drawer or kick panel.

TOOLS YOU WILL NEED

- Phillips and flat-blade screwdrivers
- Pencil and ruler
- Two pipe wrenches (one for backup)
- 3.5 cm (1½") open-end or adjustable wrench
- Nut drivers or wrenches: 5 mm (3/16") and 6 mm (1/4")

ADDITIONAL MATERIALS YOU MAY NEED

- Gas line shut-off valve.
- Pipe joint sealant or UL-approved pipe thread tape with Teflon* that resists action of butane gas.
- Flexible metal appliance connector [1.3 cm (1/2") I.D.]. A 1.5 m (5') length is recommended for ease of installation but other lengths are acceptable. Never use an old connector when installing a new range.
- Flare union adapter for connection to gas supply line [1.9 cm (3/4") or 1.3 cm (1/2") NPT x 1.3 cm (1/2") I.D.].
- Flare union adapter for connection to pressure regulator on range [1.3 cm (1/2") NPT x 1.3 cm (1/2") I.D.].

*Teflon: Registered trademark of DuPont

PREPARATION

- Remove all tape and packaging. Lift up the cooktop (on models with standard twin burners) and remove any packing material under it. Make sure the standard twin burners are properly seated and level.
- Take the accessory pack out of the oven.
- Check to be sure that no range parts have come loose during shipping.

(continued next page)



INSTALLATION INSTRUCTIONS

(continued)

1 PROVIDE ADEQUATE GAS SUPPLY

Your range is designed to operate at a pressure of 25.4 cm (10") of water column on butane gas. Make sure you are supplying your range with the type of gas for which it is designed.

If you decide to use this range on a different type of gas, conversion adjustments must be made by a service technician or other qualified person before attempting to operate the range on that gas.

For proper operation, the pressure of butane gas supplied to the regulator must be between 25.4 cm (10") and 33 cm (13") of water column. When checking for proper operation of the regulator, the inlet pressure must be at least 2.5 cm (1") greater than the operating (manifold) pressure as given above. The pressure regulator located at the inlet of the range manifold must remain in the supply line. A flexible metal appliance connector used to connect the range to the gas supply line should have an I.D. of 1.3 cm (1/2") and be 1.5 m (5') in length for ease of installation. In Canada, flexible connectors must be single wall metal connectors no longer than 1.8 m (6') in length.

2 CONNECT THE RANGE TO GAS

Shut off the main gas supply valve before disconnecting the old range and leave it off until new hook-up has been completed. Don't forget to relight the pilot on other gas appliances when you turn the gas back on.

Because hard piping restricts movement of the range, the use of an A.G.A.-certified flexible metal appliance connector is recommended unless local codes require a hard-piped connection. Never use an old connector when installing a new range. If the hard piping method is used, you must carefully align the pipe; the range cannot be moved after the connection is made.

To prevent gas leaks, use pipe joint compound or wrap Teflon* pipe thread tape around all male (external) pipe threads.

*Teflon: Registered trademark of DuPont

Gas Pipe and Electric Outlet Locations for Models Equipped with Sealed Burners

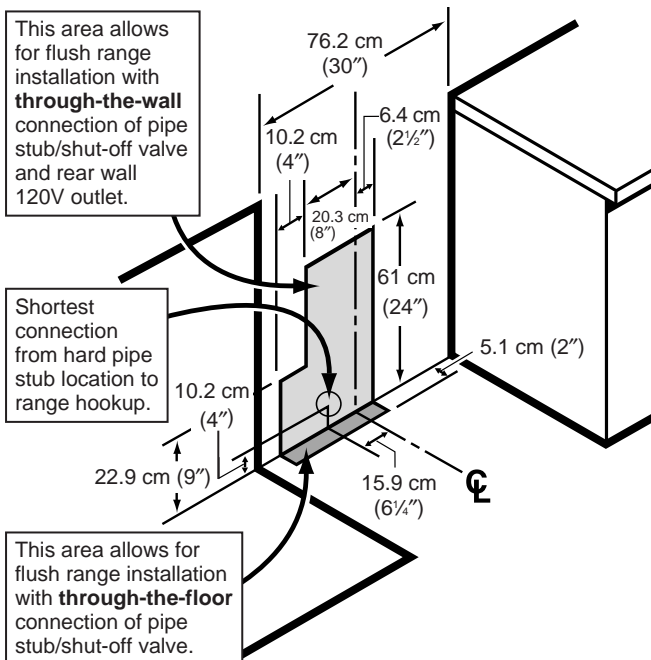

Gas Pipe and Electric Outlet Locations for Models Equipped with Standard Twin Burners

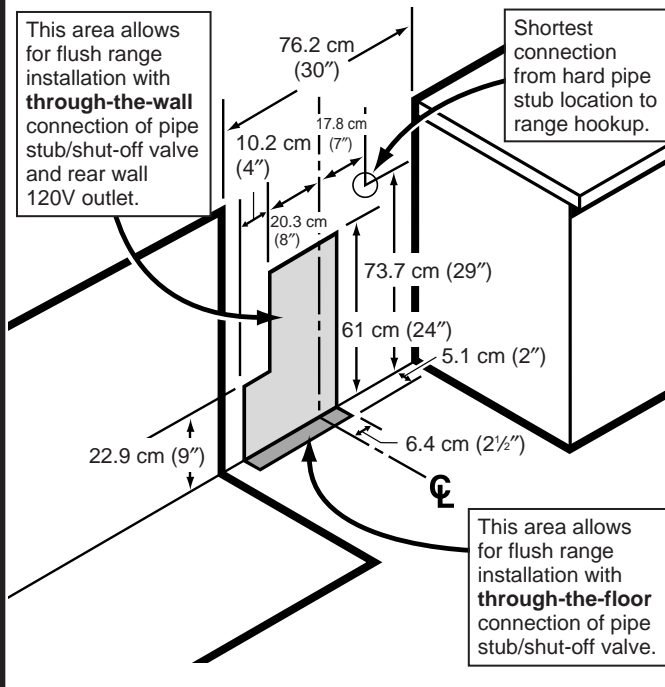



Flexible Connector Hookup for Models Equipped with Sealed Burners

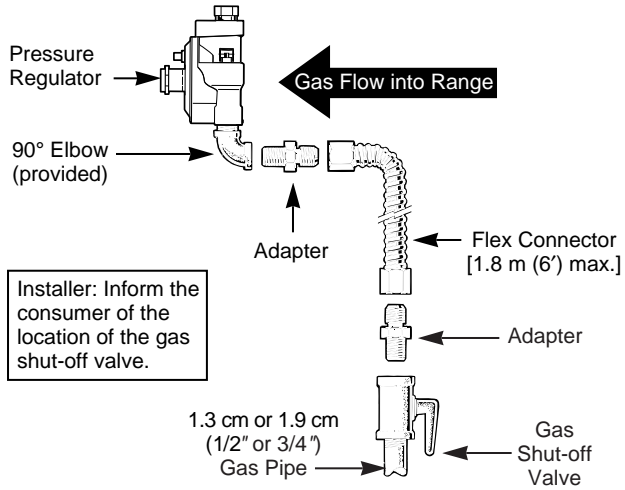

Installer: Inform the consumer of the location of the gas shut-off valve.

Rigid Pipe Hookup for Models Equipped with Sealed Burners

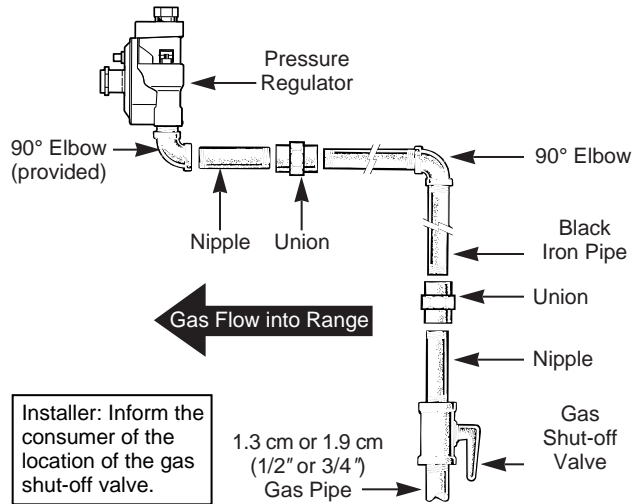

Installer: Inform the consumer of the location of the gas shut-off valve.

Flexible Connector and Rigid Pipe Hookups for Models Equipped with Standard Twin Burners

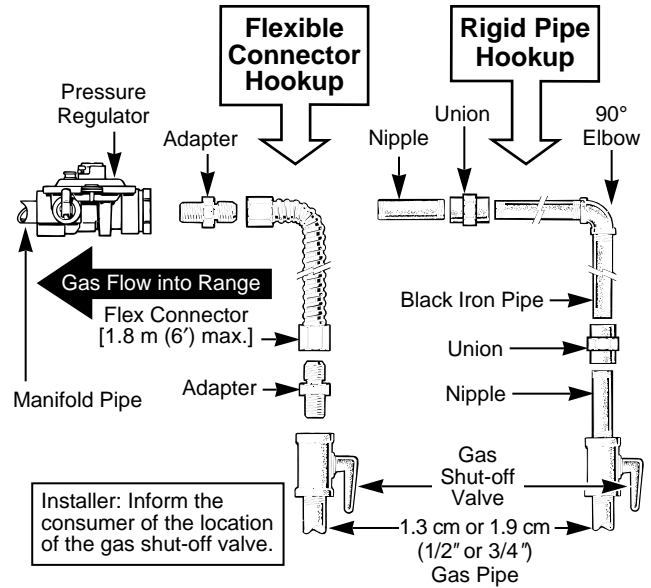

Installer: Inform the consumer of the location of the gas shut-off valve.

(continued next page)



INSTALLATION INSTRUCTIONS

(continued)

2 CONNECT THE RANGE TO GAS (continued)

1. Install a manual gas line shut-off valve in the gas line in an easily accessed location outside of the range. Make sure everyone operating the range knows where and how to shut off the gas supply to the range.
2. Install male 1.3 cm (1/2") flare union adapter to the 1.3 cm (1/2") NPT internal thread elbow at inlet of regulator. **On models equipped with standard twin burners**, install the male pipe thread end of the 1.3 cm (1/2") flare union adapter to the 1.3 cm (1/2") NPT internal thread at inlet of pressure regulator. Use a back-up wrench on the regulator fitting to avoid damage. When installing the range from the front, remove the 90° elbow for easier installation.
3. Install male 1.3 cm (1/2") or 1.9 cm (3/4") flare union adapter to the NPT internal thread of the manual shut-off valve, taking care to back up the shut-off valve to keep it from turning.
4. Connect flexible metal appliance connector to the adapter on the range. Position range to permit connection at the shut-off valve.
5. When all connections have been made, make sure all range controls are in the off position and turn on the main gas supply valve. Use a liquid leak detector at all joints and connections to check for leaks in the system.

CAUTION: DO NOT USE A FLAME TO CHECK FOR GAS LEAKS.

When using test pressures greater than 1/2 psig to pressure test the gas supply system of the residence, disconnect the range and individual shut-off valve from the gas supply piping. When using test pressures of 1/2 psig or less to test the gas supply system, simply isolate the range from the gas supply system by closing the individual shut-off valve.

3 ELECTRICAL CONNECTIONS (on some models)

Electrical Requirements

120-volt, 60 Hertz, properly grounded branch circuit protected by a 15-amp or 20-amp circuit breaker or time delay fuse.

Extension Cord Cautions

Because of potential safety hazards associated with certain conditions, we strongly recommend against the use of an extension cord. However, if you still elect to use an extension cord, it is absolutely necessary that it be a UL-listed, 3-wire grounding-type appliance extension cord and that the current carrying rating of the cord in amperes be equivalent to, or greater than, the branch circuit rating.

Grounding

IMPORTANT—(Please read carefully)

FOR PERSONAL SAFETY, THIS APPLIANCE MUST BE PROPERLY GROUNDED.

PREFERRED METHOD

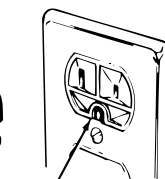
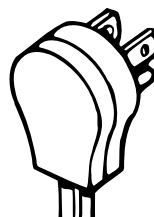

Ensure proper ground exists before use

The power cord of this appliance is equipped with a three-prong (grounding) plug which mates with a standard three-prong grounding wall receptacle to minimize the possibility of electric

shock hazard from this appliance.

The customer should have the wall receptacle and circuit checked by a qualified electrician to make sure the receptacle is properly grounded.

Where a standard two-prong wall receptacle is encountered, it is the personal responsibility and obligation of the customer to have it replaced with a properly grounded three-prong wall receptacle.

DO NOT, UNDER ANY CIRCUMSTANCES, CUT OR REMOVE THE THIRD (GROUND) PRONG FROM THE POWER CORD.



A Usage Situations where Appliance Power Cord will be Disconnected Infrequently.

An adapter may be used only on a 15-amp circuit. Do not use an adapter on a 20-amp circuit. Where local codes permit, a **TEMPORARY CONNECTION** may be made to a properly grounded two-prong wall receptacle by the use of a UL-listed adapter, available at most hardware stores. The larger slot in the adapter must be aligned with the larger slot in the wall receptacle to provide proper polarity in the connection of the power cord.

TEMPORARY METHOD

(Adapter plugs not permitted in Canada)

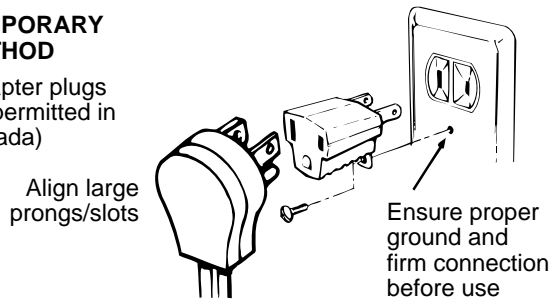

CAUTION: Attaching the adapter ground terminal to the wall receptacle cover screw does not ground the appliance unless the cover screw is metal, and not insulated, and the wall receptacle is grounded through the house wiring. The customer should have the circuit checked by a qualified electrician to make sure the receptacle is properly grounded.

When disconnecting the power cord from the adapter, always hold the adapter with one hand. If this is not done, the adapter ground terminal is very likely to break with repeated use. Should this happen, **DO NOT USE** the appliance until a proper ground has again been established.

B Usage Situations where Appliance Power Cord will be Disconnected Frequently.

Do not use an adapter plug in these situations because disconnecting of the power cord places undue strain on the adapter and leads to eventual failure of the adapter ground terminal. The customer should have the two-prong wall receptacle replaced with a three-prong (grounding) receptacle by a qualified electrician before using the appliance.

The installation of appliances designed for mobile home installation must conform with the Manufactured Home Construction and Safety Standard, Title 24 CFR, Part 3280 (formerly the Federal Standard for Mobile Home Construction and Safety, Title 24, HUD, Part 280) or, when such standard is not applicable, the Standard for Manufactured Home Installations, latest edition (Manufactured Home Sites, Communities and Set-Ups), ANSI A225.1, latest edition, or with local codes. In Canada, mobile home installation must be in accordance with the current CAN/CSA Z240/MH Mobile Home Installation Code.

Electric Disconnect

- 1. Locate disconnect plug on the range back.
- 2. Pinch sides of connector and pull out of range back.

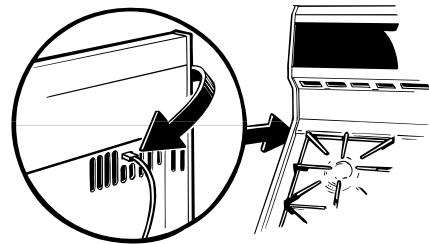

(continued next page)



INSTALLATION INSTRUCTIONS

(continued)

4 SEAL THE OPENINGS

Seal any openings in the wall behind the range and in the floor under the range when hookups are completed.

5 CHECK IGNITION OF SURFACE BURNERS

Surface Burner Ignition

Operation of all cooktop and oven burners should be checked after the range and gas supply lines have been carefully checked for leaks.

Electric Ignition Models

Select a top burner knob and simultaneously push in and turn to LITE position. You will hear a snapping sound indicating proper operation of the spark module. Once the air has been purged from the supply lines, burners should light within 4 seconds. After burner lights, rotate knob out of the LITE position. Try each burner in succession until all burners have been checked.

Quality of Flames

The combustion quality of burner flames needs to be determined visually.



(A) Yellow flames—
Call for service

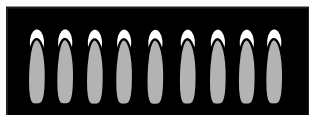

(B) Yellow tips on
outer cones—
Normal for
butane gas

If burner flames look like (A), call for service. Normal burner flames should look like (B).

With butane gas, some yellow tipping on outer cones is normal.

6 CHECK IGNITION OF OVEN BURNER

The oven is designed to operate quietly and automatically. To operate the oven, press the BAKE pad and then press the + pad until "350°" appears in the display. After 30-90 seconds, the oven burner will ignite and burn until the set temperature is reached. The oven burner will continue to cycle on and off as necessary to maintain the oven at the temperature indicated by the display.

To check ignition of the broil burner, press the BROIL pad and then the + or - pad. After 30-90 seconds, the broil burner will ignite.

Electric ignition models require electrical power to operate. In case of a power outage, the oven burners on these models cannot be lit manually with a match. Gas will not flow unless the glow bar is hot.

If the oven is in use when a power outage occurs, the burner will shut off and cannot be re-lit until power is restored.



7 ADJUST BROIL AND OVEN BURNER AIR ADJUSTMENT SHUTTERS IF NECESSARY

Air adjustment shutters for the top and bottom burners regulate the flow of air to the flames.

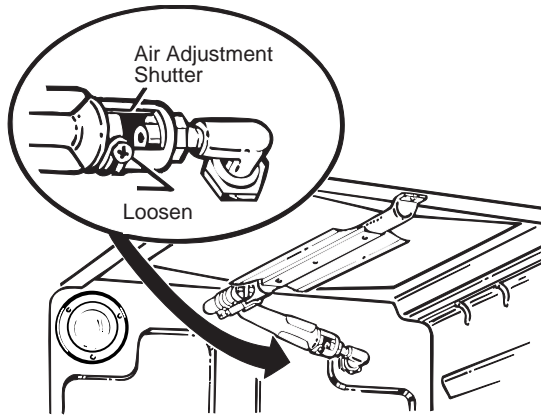

The air adjustment shutter for the top (broil) burner is in the center of the rear wall of the oven.

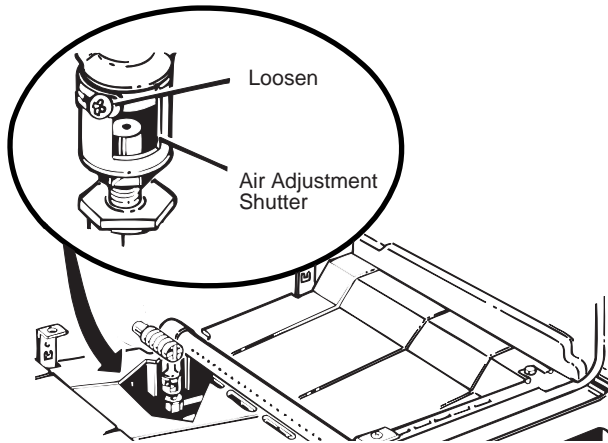

The shutter for the bottom (oven) burner is near the back wall behind the storage drawer or the kick panel (depending on the model). Remove the drawer or panel. See the Care and Cleaning section in this guide.

To adjust the flow of air to either burner, loosen the Phillips head screw and rotate the shutter toward open or closed position as needed.

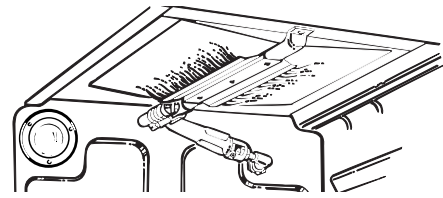

The flames for the top (broil) burner should be steady with approximately 2.5 cm (1") blue cones and should not extend out over the edges of the burner baffle.

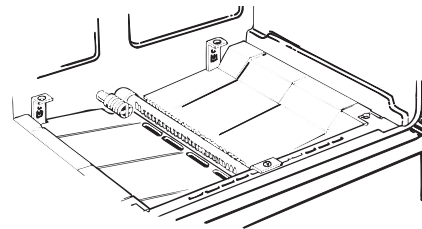

To determine if the bottom burner flames are burning properly, remove the oven bottom. Flames should have approximately 2.5 cm (1") blue cones with small yellow tips at the end of outer cones. Flames should not lift off burner ports. If lifting is observed, gradually reduce air shutter opening until flames are stabilized.

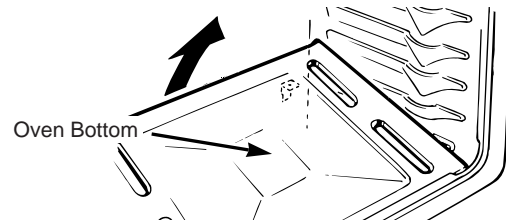

To remove the oven bottom:

1. Remove the knurled screws holding down rear of the oven bottom.
2. Grasp the oven bottom at finger slots on each side.
3. Lift the rear of the oven bottom enough to clear the lip of the range frame, then pull out.

(continued next page)



INSTALLATION INSTRUCTIONS

(continued)

8 LEVELING THE RANGE

1. Remove the storage drawer or kick panel.
2. Use a 5 mm (3/16") open-end or socket wrench to back out both rear leveling legs approximately two turns.
3. Use a 3.5 cm (1 3/8") open-end or adjustable wrench to back out the front leveling legs two turns.
4. Install the oven shelves in the oven and position the range where it will be installed.
5. Check for levelness by placing a spirit level or a cup, partially filled with water, on one of the oven shelves. If using a spirit level, take two readings—with the level placed diagonally first in one direction and then the other.
6. Adjust the leveling legs until the range is level.
7. After the range is level, slide the range away from the wall so that the Anti-Tip device can be installed.

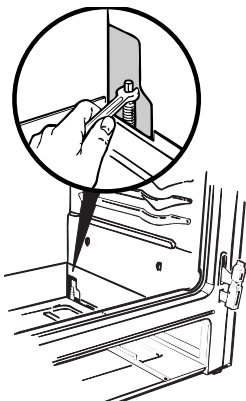

9 INSTALLING THE ANTI-TIP DEVICE

WARNING:

- Range **MUST** be secured with an approved Anti-Tip device.
- Unless properly installed, the range could be tipped by you or a child standing, sitting or leaning on an open door.
- After installing the Anti-Tip device, verify that it is in place by carefully attempting to tilt the range forward.
- This range has been designed to meet all recognized industry tip standards for all normal conditions.
- The use of this device does not preclude tipping of the range when not properly installed.
- If the Anti-Tip device supplied with the range does not fit this application, use the universal Anti-Tip device WB02X7909.

1. Mark the wall where the RIGHT EDGE of the range is to be located. Be sure to allow for the countertop overhang if you intend to install the range next to cabinets.

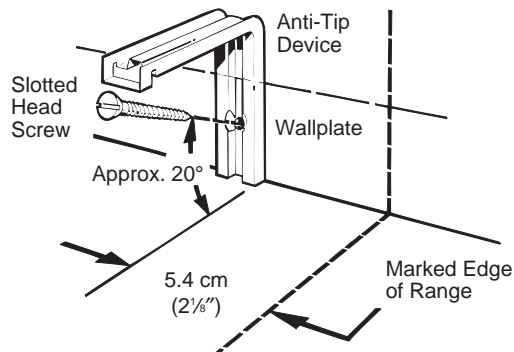

2. Locate the outside edge of the device 5.4 cm (2 1/8") toward the center of the range from the marked edge of the range.

3. Using the device as a template, mark the position of the hole for the screw.

4. For wood construction, drill a pilot hole at an angle of 20 degrees from the horizontal. A nail or awl may be used if a drill is not available.

Mount the Anti-Tip device with the screw provided.

For cement or concrete construction, you will need a 6 mm x 3.8 cm (1/4" x 1 1/2") lag bolt and a 1.3 cm (1/2") O.D. sleeve anchor, which are not provided. Drill the recommended size hole for the hardware.

Install the sleeve anchor into the drilled hole and then install the lag bolt through the device. The bolts must be properly tightened as recommended for the hardware.

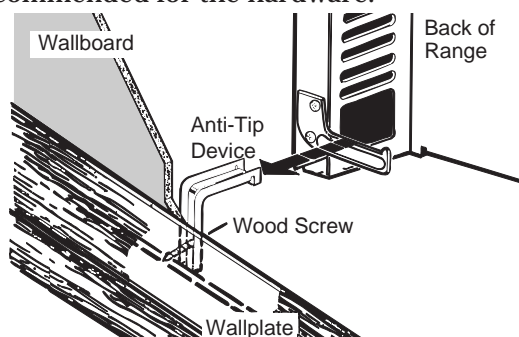

5. Slide the range against the wall, and check for proper installation by grasping the front edge of the cooktop and carefully attempting to tilt the range forward.

WHEN ALL HOOKUPS ARE COMPLETED:

MAKE SURE ALL CONTROLS ARE LEFT IN THE OFF POSITION.

MAKE SURE THE FLOW OF COMBUSTION AND VENTILATION AIR TO THE RANGE IS UNOBSTRUCTED.

QUESTIONS? BEFORE YOU CALL FOR SERVICE...

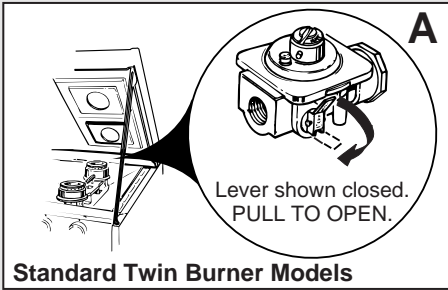
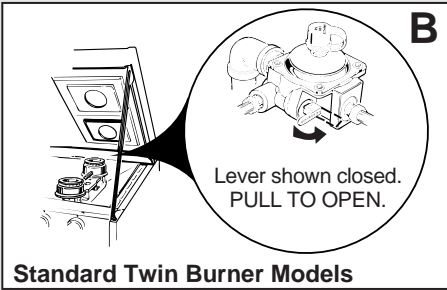
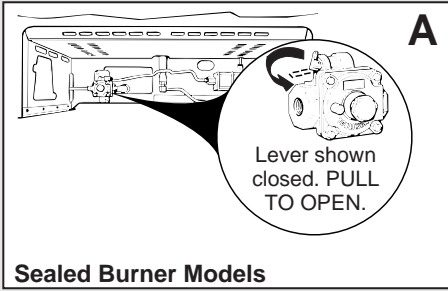
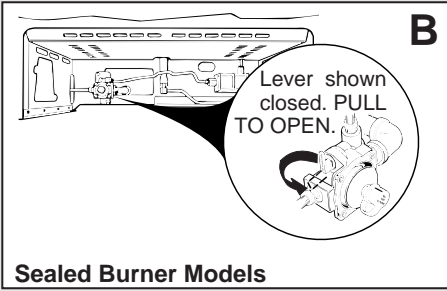

PROBLEM	POSSIBLE CAUSE
TOP BURNERS DO NOT LIGHT OR DO NOT BURN EVENLY	<ul style="list-style-type: none"> • Make sure electrical plug is plugged into a live power outlet. • Burner holes on the side or around the top of burner may be clogged. Remove burners (on models with standard twin burners) or burner heads (on models with sealed burners) or burner caps on spill-proof models, and clean them with a sewing needle or twist tie. Make sure you do not enlarge the holes. On spill-proof models, check electrode area for burned-on food or grease. • Make sure the drip pans are installed correctly. • Pilot(s) is (are) not lit (on standing pilot models). See the Lighting Instructions for Standing Pilot Models in Surface Cooking.
SURFACE BURNERS LIGHT BUT OVEN DOES NOT	<p>• The oven gas shut-off valve may have accidentally been moved during cleaning or moving.</p> <p>To check the oven gas shut-off valve on standard twin burner models, raise the cooktop and look for the gas shut-off lever at the extreme right rear corner. (Standing pilot models do not have a gas shut-off valve on the regulator.)</p> <p>Follow the directions in box A or B that match your regulator type.</p> <div style="display: flex; justify-content: space-around;"> <div data-bbox="553 842 997 1129">  <p style="text-align: center;">Standard Twin Burner Models</p> </div> <div data-bbox="1019 842 1463 1129">  <p style="text-align: center;">Standard Twin Burner Models</p> </div> </div> <p>To check the oven gas shut-off valve on sealed burner models, remove the storage drawer, broiler drawer or kick panel and look for the gas shut-off lever at the back of the range.</p> <p>Follow the directions in box A or B that match your regulator type.</p> <div style="display: flex; justify-content: space-around;"> <div data-bbox="553 1293 997 1581">  <p style="text-align: center;">Sealed Burner Models</p> </div> <div data-bbox="1019 1293 1463 1581">  <p style="text-align: center;">Sealed Burner Models</p> </div> </div>
CLOCK DOES NOT WORK	<ul style="list-style-type: none"> • Range electrical plug must be securely seated in a live power outlet. Check for blown fuse or tripped circuit breaker.
OVEN LIGHT DOES NOT COME ON	<ul style="list-style-type: none"> • Bulb may be loose or burned out. • Electrical plug must be plugged into a live power outlet.
NIGHT LIGHT DOES NOT WORK	<ul style="list-style-type: none"> • Fluorescent bulb is loose or defective. Adjust or replace. • Switch operating the light is broken. Call for service.

(continued next page)



BEFORE YOU CALL FOR SERVICE...

(continued)

PROBLEM	POSSIBLE CAUSE
OVEN WILL NOT WORK	<ul style="list-style-type: none">• Plug on the range is not completely inserted in the electrical outlet.• Pilot(s) is (are) not lit (on standing pilot models). See the Lighting Instructions for Standing Pilot Models in Using Your Oven.• The circuit breaker in your house has been tripped, or a fuse has been blown.• Oven controls not properly set.
OVEN TEMPERATURE TOO HOT OR TOO COLD	<ul style="list-style-type: none">• The oven thermostat needs adjustment. See the Adjust the Oven Thermostat—<i>Do It Yourself</i> section.
FOOD DOES NOT ROAST OR BAKE PROPERLY	<ul style="list-style-type: none">• Oven controls not properly set. See the Baking or Roasting section.• Shelf position is not correct.• Incorrect cookware or cookware of improper size is being used.• The oven thermostat needs adjustment. See the Adjust the Oven Thermostat—<i>Do It Yourself</i> section.• Clock not set correctly.• Oven bottom not securely seated in position.
FOOD DOES NOT BROIL PROPERLY	<ul style="list-style-type: none">• Oven controls not properly set. See the Broiling section.• Oven door not closed.• Improper shelf position being used. See the Broiling section.• Food is being cooked on a hot pan.• Cookware is not suited for broiling.• Aluminum foil used on the broiler pan grid has not been fitted properly and slit as recommended.• Oven bottom not securely seated in position.
OVEN WILL NOT SELF-CLEAN	<ul style="list-style-type: none">• Oven temperature is too high to set self-clean operation. Allow the range to cool to room temperature and reset the controls.• Door latch handle not moved all the way to the right.
OVEN DOOR WILL NOT UNLOCK	<ul style="list-style-type: none">• Oven must cool below locking temperature. Do not lock the door with door latch except when using self-clean feature or the oven may lock.
OVEN NOT CLEAN AFTER CLEAN CYCLE	<ul style="list-style-type: none">• Oven controls not set properly. See Operating the Self-Cleaning Oven section.• Heavily soiled oven requires 3½ to 4 hours of cleaning time.• Heavy spillovers should be cleaned up before starting clean cycle.
OVEN DOOR ACCIDENTALLY LOCKED WHILE BAKING	<ul style="list-style-type: none">• Press the CLEAR/OFF pad. Allow the oven to cool and then unlatch the door.



PROBLEM	POSSIBLE CAUSE
“door” APPEARS IN THE DISPLAY	<ul style="list-style-type: none">• Self-cleaning cycle has been selected but latch handle was not moved all the way to the right. Move the latch handle.• Latch handle was moved to the right but a program other than self-cleaning was selected. Move the latch handle to the right only when setting the self-cleaning cycle.
“F—AND A NUMBER” FLASH IN THE DISPLAY	<ul style="list-style-type: none">• If the time display flashed “F—and a number,” you have a function error code. If a function error code appears during the self-cleaning cycle, check the oven door latch. The latch handle may have been moved, even if only slightly, from the latched position. Make sure the latch is moved to the right as far as it will go. Press the CLEAR/OFF pad. Allow the oven to cool for one hour. Put the oven back into operation.• Disconnect all power to the range for 5 minutes and then reconnect power. If the failure code repeats, then call for service.
OVEN CONTROL SIGNALS AFTER ENTERING COOKING TIME OR START TIME	<ul style="list-style-type: none">• This is reminding you to enter a bake temperature (see the Baking section).
RAINBOW EFFECT IN THE OVEN WINDOW (on some models)	<ul style="list-style-type: none">• This is normal. It is caused by the heat treatment applied to the oven window.
STRONG ODOR	<ul style="list-style-type: none">• Improper air/gas ratio in oven. Adjust oven burner air shutter.• An odor from the insulation around the oven liner is normal for the first few times oven is used. This is temporary.

