

# AJEQ12DWJ

GEA 230/208 Volt Built-In Heat-Cool Room Air Conditioner with Built-in WiFi SmartHQ™

BTU – 11,800 / 11,700

CEER – 9.5/9.5

## WALL CASE DIMENSIONS AND INSTALLATION INFORMATION (IN INCHES)

**NOTE:** When installing slide-out chassis units in through-the-wall applications, keep louvers free. Do not restrict air flow areas.

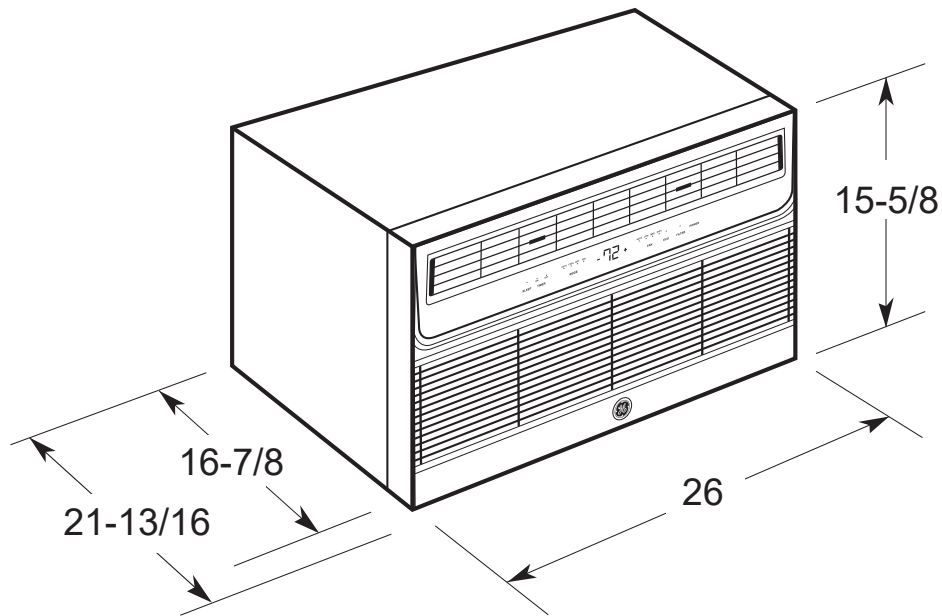

Perpendicular NEMA 6-20P  
230 / 208 V

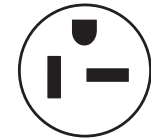

**GE APPLIANCES**  
a Haier company

For answers to your Monogram™, GE Café™, GE Profile™ or  
GEAppliances product questions, visit our website at [GEAppliances.com](http://GEAppliances.com)  
or call GE Answer Center Service, 800.626.2000.



Total volume and shelf  
area are calculated  
by the Association  
of Home Appliance  
Manufacturers'  
standards.



# AJEQ12DWJ

## GEA 230/208 Volt Built-In Heat-Cool Room Air Conditioner with Built-in WiFi SmartHQ™

### DIMENSIONS (IN INCHES)

**INSTALLATION INFORMATION:** A finished opening of 26-1/8" x 15-3/4" clear of intrusions is required. Keep clearance of 4" from side walls. Brick veneer or frame walls should have wood studding surrounding case to provide firm anchoring with screws. Case can be fastened directly to brick or block walls with screws sunk in lead expansion shields.

**NOTE:** Units should be caulked on all four sides of case to the building exterior to assure building integrity.

### WALL CASE FOR TENANT OPTION INSTALLATION:

When the air conditioner is offered as a tenant option, this wall case provides protection against outside elements.

**RAB26A** – includes wall sleeve, exterior grille, steel closure panel and two layers of insulation.

### STANDARD WALL SLEEVE RAB26A:

Solid-sided wall case fabricated of galvanized steel with baked enamel finish. Welded areas are coated with a sealing compound to help resist rust and corrosion. Polymer gasket surrounds opening to assure tight weather seal. Aluminum grille **RAG13A** is included. Panels on interior and between case and grille provide weather protection prior to installation of chassis. Provide firm anchoring with screws. Case can be fastened directly to brick or block walls with screws sunk in lead expansion shields.

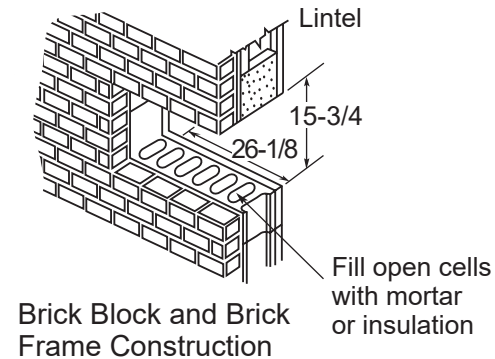
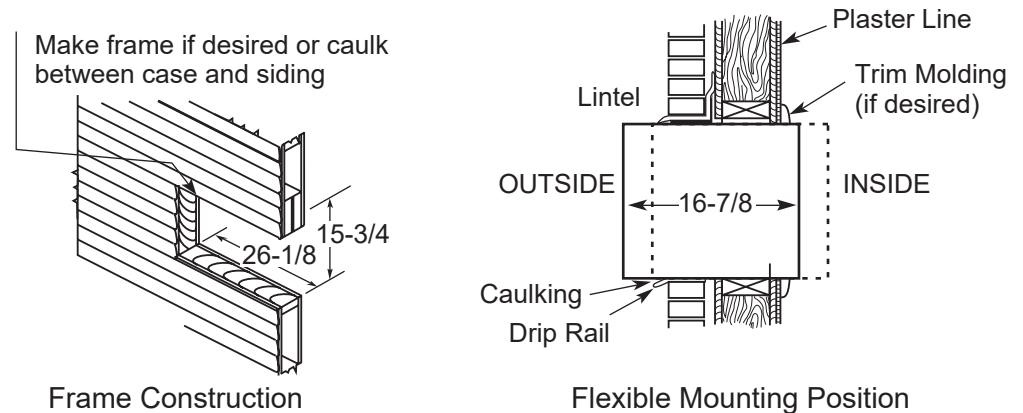

**GE APPLIANCES**  
a Haier company

For answers to your Monogram™, GE Café™, GE Profile™ or GE Appliances product questions, visit our website at [GEAppliances.com](http://GEAppliances.com) or call GE Answer Center Service, 800.626.2000.



Total volume and shelf area are calculated by the Association of Home Appliance Manufacturers' standards.



# AJEQ12DWJ

GEA 230/208 Volt Built-In Heat-Cool Room Air Conditioner with Built-in WiFi SmartHQ™

## FEATURES AND BENEFITS

- **True Built In Design** – The ultimate fit & finish for more usable space and the best in built-in installation. Sleeve and chassis are perfectly integrated, creating a seamless fit without leaks or gaps
- **Premium Finish** – Bright, clean color & a decorative metallic silver accent encasing the air discharge louver, provide an overall sleek appearance
- **Electronic Cap Touch Controls** – Controls offer a high-end and smooth to-the-touch panel
- **Large LCD Auto-Dimming Display** – Intuitive & large white LCD display can be easily seen from anywhere in the room. Convenient Auto-Dimming feature provides ambient lighting during the night
- **Slim Room Front** – A slim room front provides more usable space in the room. It's the sleekest design in the industry
- **ECO Mode** – Innovative mode where the fan cycles off during cooling intervals, creating energy savings while keeping the room comfortable
- **Dry Mode** – Designed for humid environments, it helps provide a dryer & more comfortable atmosphere with room-air dehumidification
- **Auto Mode** – Automatically select heating or cooling mode and fan speed to maintain the current temperature setpoint. It monitors the room temperature for optimal comfort
- **3-Speed Fan** – Select High, Medium, Low or Auto Setting to achieve the best in air comfort & ultimate flexibility. Available on heat-cool models
- **6-Way Directional Airflow** – Direct where the air flows with up to 6 directional vents—cooling and/or heating the areas of the room that need it the most
- **Washable Filter** – Easy to remove and rinse clean, the filter helps remove dust and other particles from transmitting in the air—providing a cleaner environment
- **Remote Control Included** – Slim, intuitive and easy to use, the remote control enables adjusting temperatures and settings conveniently from anywhere in the room
- **Quiet Performance** – Designed & engineered by GE Appliances for ultra-quiet comfort
- **Commercial Grade** – Designed for durability with high-grade components and tested for long performance
- Model AJEQ12DWJ – White

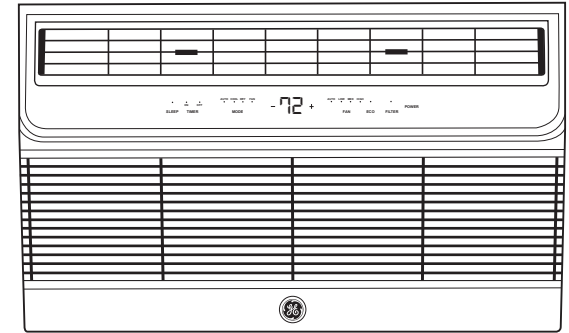

**GE APPLIANCES**  
a Haier company