

HOTPOINT®

HTR17BBS – Hotpoint® 16.6 Cu. Ft. Top-Freezer Refrigerator

Front View

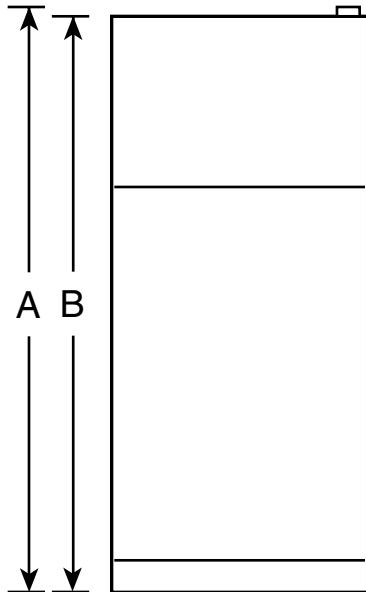

Top View

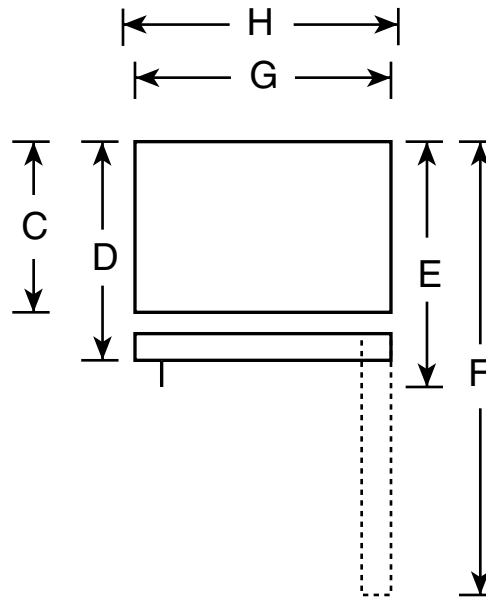

Overall Dimensions	Height to top of hinge (in.) A	64-3/4
	Height to top of case (in.) B	64-1/4
	Height to mid-freezer (in.)	54-3/8
	Case depth without door (in.) C	25-7/8
	Case depth less door handle (in.) D	29-1/8
	Case depth with door handle (in.) E	29-1/8
	Depth with fresh food door open 90° (in.) F	54-7/8
	Width (in.) G	28
Air Clearances	Width with door open 90° with door handle (in.) H	28-5/8
	Each side (in.)	3/4
	Top (in.)	1
	Back (in.)	1

Note: Before installing, consult installation instructions packed with product for current dimensional data.

Note: All Top-Freezer No-Frost Right-Hand Refrigerator Doors: As you face the front of the refrigerator, the handle is on your left and the hinges are on your right.

All Top-Freezer No-Frost Left-Hand Refrigerator Doors: As you face the front of the refrigerator, the handle is on your right and the hinges are on your left.





HTR17BBS – Hotpoint® 16.6 Cu. Ft. Top-Freezer Refrigerator

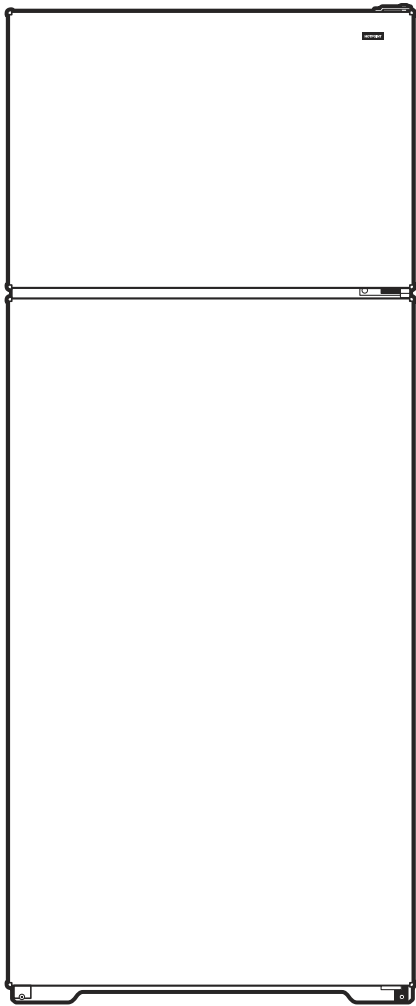

Features and Benefits

- Upfront Temperature Controls - Are positioned up front, close at hand, for maximum convenience and ease of use
- Recessed handles - Color-matched recessed door handles reflects the latest in European style and appearance
- Adjustable Wire Shelves - Minimizes usable storage space
- Gallon Door Storage - Makes room for milk and any other gallon size containers
- Vegetable/Fruit Crispers - For easy storage of your fruits and vegetables
- NeverClean™ Condenser - Condenser coils are encased, so they don't require cleaning in normal operating environments
- Deluxe Quiet Design - Significantly reduces operating noise
- Model HTR17BBSWW – White on white
- Model HTR17BBSCC – Bisque on bisque