



quick installation guide

Instructions en Français - Voir le Manuel du propriétaire • Instrucciones en Español - Ver el Manual de instrucciones

This quick reference guide is provided for informational purposes only and does not replace, modify or change in any manner the *Owner's Manual & Installation Instructions*.



DO NOT DISCARD. RETAIN FOR FUTURE USE.

View videos on installation steps at www.geappliances.com/videos-media/

⚠ WARNING

For your safety

- To reduce the risk of fire, electric shock, or injury to persons when using or installing the product, read and obey all safety information provided in the *Owner's Manual & Installation Instructions* that accompanied the product.
- Do not install or store appliance in an area where it will be exposed to dripping water or outside weather conditions. See Location of Your Washer section in the *Owner's Manual & Installation Instructions*.
- **NOTE:** This appliance must be properly grounded and installed as described in these steps and the *Owner's Manual & Installation Instructions*. Electrical service to the washer must conform with local codes and ordinances and the latest edition of the national Electrical Code, ANSI/NFPA 70.

1 Unpack your washer

Parts supplied

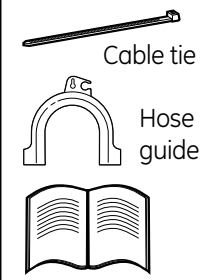

Parts required

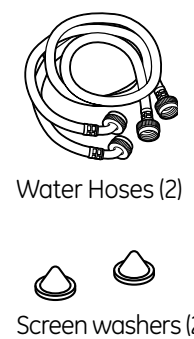

Tools needed

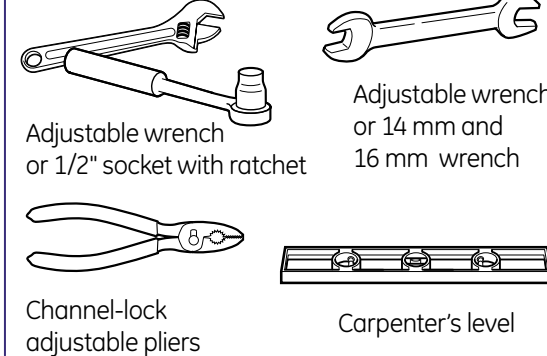

3 Connect hoses to washer

Run water from both faucets to flush the lines and remove particles that might clog the water valve screens.

Ensure that a rubber washer is in the end of the hot and cold hoses.

Connect the inlet hoses to the hot "H" outlet and cold "C" outlet.

Hand-tighten and then tighten them another 2/3 turn with pliers.

Do not crossthread or over-tighten these connections.

GE recommends inlet hoses that have a 90 degree bend at one end. The 90 degree bend should be installed at the washer as shown above.

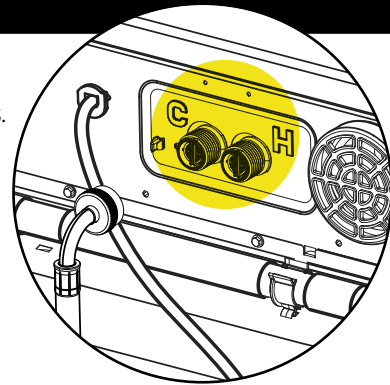

4 Connect hoses to water supply

Ensure that a screen washer is inserted into the faucet end of both hoses with protruded side facing the faucet. If a rubber washer is already inserted, remove before inserting screen washer.

Connect the inlet hose from the "H" outlet to the hot faucet and the inlet hose from the "C" outlet to the cold faucet.

Hand-tighten and then tighten them another 2/3 turn with pliers.

Turn on the water and check for leaks.

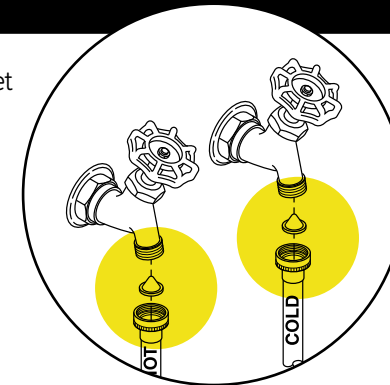

5 Level your washer

Gently rock the washer into final location, ensuring inlet hoses do not become kinked. Do not use door or dispenser drawer to lift the washer.

Place level on top.

Loosen nut then adjust the front leveling legs up or down using a 14 mm or adjustable wrench.

Level washer both side-to-side and front-to-back.

Hand tighten nuts toward the base of the washer and tighten with a 16 mm wrench until a minimum of 3 clicks.

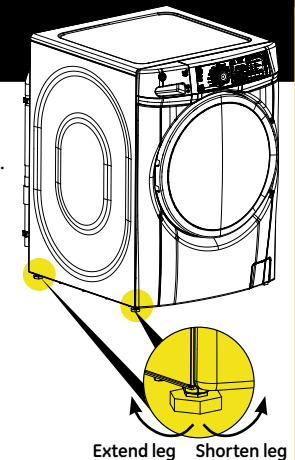

6 Install drain hose and plug

Attach U-shaped hose guide to end of drain hose.

Place hose in laundry tub or standpipe and secure with cable tie.

If placed in standpipe, the end of the drain hose should extend only 4 to 7 inches down the pipe.

Plug washer into a grounded outlet. Do not use an extension cord or adaptor plug.

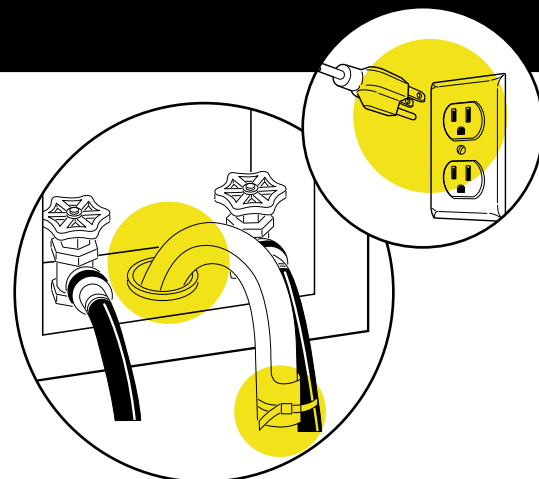

7 Final installation checklist

- Main power is turned on.
- The washer is plugged in.
- Faucets are turned on.
- Water hoses are connected securely with no leaks at both ends.
- Unit is level and all legs are on the floor.
- Shipping bolts and spacers are removed and stored for future use.
- Drain hose is placed in tub or standpipe and secured with a cable tie.

8 Test cycle

Run a load of clothes in the SPEED WASH cycle.

Check for leaks.

When the load is spinning at high speed, ensure that the washer and leveling legs are stable.

If necessary, pause the cycle and adjust the front leveling legs until the washer is properly level. Restart the cycle in order to allow it to finish.

Video



Scan this code to watch a video on Step 2.

Video



Scan this code to watch a video on Step 5.

consumer quick reference guide

Instructions en Français - Voir le Manuel du propriétaire • Instrucciones en Español - Ver el Manual de instrucciones

This quick reference guide is provided for informational purposes only and does not replace, modify or change in any manner the *Owner's Manual & Installation Instructions*.



DO NOT DISCARD. RETAIN FOR FUTURE USE.

View videos on use and care at www.geappliances.com/videos-media/

getting started

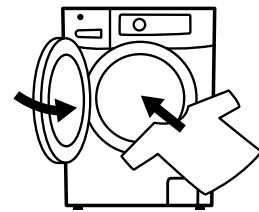

- 1 Load clothes into your washer and close the door.

Power



- 2 Press Power to turn on the washer.

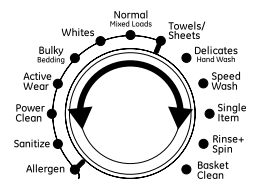

- 3 Turn the Knob to the desired cycle or use My Cycle to program or recall your favorite cycle.

My Cycle

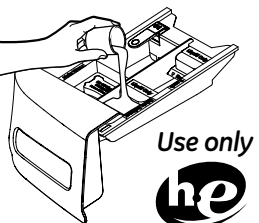
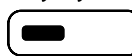

Use only
HE
detergent

- 4 Open the dispenser and add detergent, bleach and fabric softener, as desired. *This washer multi-doses the detergent in small amounts during wash to achieve the best cleaning.*

Start/Pause



- 5 Press start to begin the wash cycle. *The machine will weigh your clothes and add the proper amount of water. When the wash cycle is finished, the door will unlock.*

Great features of this washer



Uses the ideal pre-programmed wash & rinse settings to tackle five common tough stains.



For select cycles, the washer will add steam early in the cycle to assist with loosening stains.

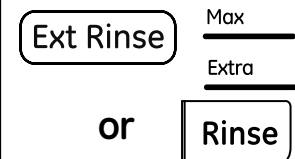

Use to obtain on Extra Rinse after the primary rinse. On some models, a third rinse (Max) can be selected.

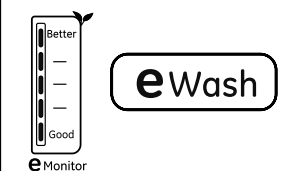

On certain cycles, you can save energy by selecting the eWash option to adjust water temperature and spin times.

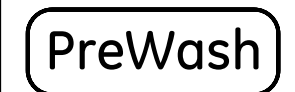

For heavily soiled items, select this extra wash before the main wash using prewash detergent in the dispenser.



For soaking items before washing. After a brief tumble, items can soak for 30 minutes to 8 hours per your selection.



For select cycles, the washer will tumble dry a small load for up to 8 hours after washing so clothes will be ready to wear.

truths and myths

For a list of truths and myths about frontload washers, please consult your Owner's Manual under the section titled *Before you call for service...*

service

Before you call for service, review the detailed troubleshooting tips in the Owner's Manual. If needed, schedule a visit from GE's local factory service team for advanced, outstanding service by visiting localgeappliancerepair.com or calling 866.530.7025.

care & cleaning

cleaning the pump filter

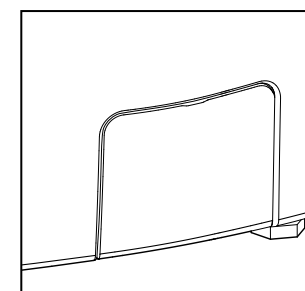
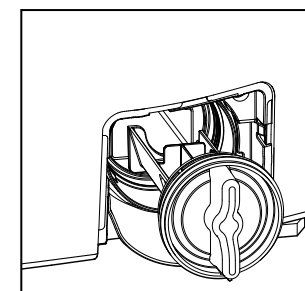
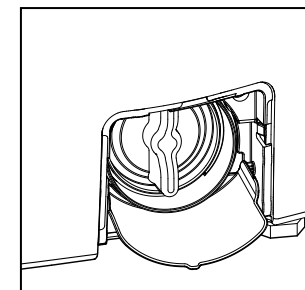
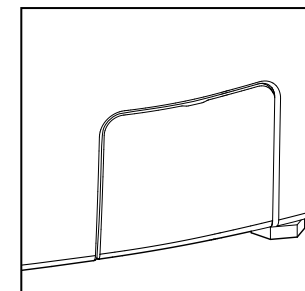

NOTE: Clean pump filter every 6 months or sooner if unit is not draining properly.

Video



Scan this code to watch a video on this topic.

STEP 1: Open the access door using a coin or flat screwdriver in the notch of the door and pull down the pour spout.

STEP 2: Place a shallow pan or dish under the pump access door and towels on the floor for protection. It is normal for up to a cup of water to drain from the filter.

STEP 3: Turn pump filter counterclockwise and remove the filter slowly to let the water drain.

STEP 4: Clean the debris from the filter.

STEP 5: Replace the filter by pushing in firmly and turning clockwise until tightened securely. Flip up the pour spout and close the access door.

To ensure that your washer operates as designed, please follow the care and cleaning steps detailed below

cleaning the interior of the washer

To clean the interior of the washer, use the BasketClean feature located on the control panel using the following procedure:

STEP 1: Remove any garments or objects from the washer to ensure the basket is empty.

STEP 2: Open the washer door and add tub cleaner or lime scale remover directly into the washer basket.

STEP 3: Close the door and select the BasketClean cycle. Push the START button.

STEP 4: When the BasketClean cycle is working, you will see CLN on the display. The cycle will complete in about 90 minutes. Do not interrupt the cycle.

IMPORTANT

- Run BasketClean with tub cleaner once a month.
- After the completion of a BasketClean cycle, the interior of your washer may have a bleach smell
- It is recommended to run a light-color load after the BasketClean cycle

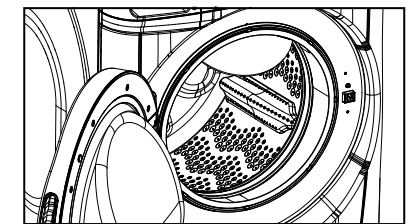

STEP 5: After the cycle is complete, leave the door open slightly for ventilation.

BasketClean may be interrupted by pressing the START/PAUSE button in between cycles. When interrupted, be sure to run a complete BasketClean cycle before using the washer.

For more information on the BasketClean feature, refer to your Owner's Manual & Installation Instructions.

cleaning the door gasket

STEP 1: Open the washer door.

STEP 2: Press down on the door gasket and pull down on the interior gasket with your fingers.

STEP 3: Remove any foreign objects trapped inside the interior gasket.

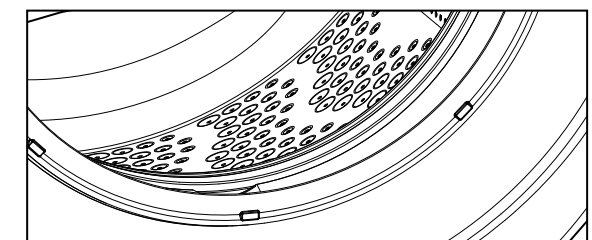

STEP 4: When finished cleaning, remove your hands and the gasket will return to operating condition.

NOTE: Make sure nothing is blocking the holes behind the gasket.

routine maintenance

Genuine GE Parts and Accessories make appliance maintenance easy by providing cleaning products, replacement parts and accessories that are designed to keep your appliance at peak performance. To order direct visit geapplianceparts.com or call 800.626.2002.