

PTD60GBSR/BPR

GE Profile™ 7.4 cu. ft. Capacity aluminized alloy drum Gas Dryer with Sanitize Cycle and Sensor Dry

DIMENSIONS AND INSTALLATION INFORMATION (IN INCHES)

EXHAUST OPTION: When viewed from the front of the unit, exhaust 3-way via rear, left and bottom. Dryer is shipped exhausted to the rear. Alternate exhausting knockouts are supplied.

GAS: An individual, properly-grounded branch circuit, with a three-prong grounding-type receptacle, protected by a 15 or 20 amp circuit breaker or a time-delay fuse is required.

GAS DRYER ELECTRIC RATING: 120V, 60Hz, 7A

GAS (BTU/HR): 22,000. Factory-equipped for natural gas. Tested for LP gas. LP gas supply requires a conversion kit. Check installation instructions for correct kit and have a qualified gas technician install a conversion kit. See dryer ducting information for proper installation.

NOTE: Dryer wall outlet must be located within 36" of service cord entry and accessible when dryer is mounted in position.

INSTALLATION INFORMATION: For complete information, see installation instructions packed with your dryer.

SPECIAL INSTALLATION REQUIREMENTS

ALCOVE OR CLOSET INSTALLATION:

- If your dryer is approved for installation in an alcove or closet, it will be stated on a label on the dryer back.
- The dryer **MUST** be exhausted to the outside.
- Minimum clearances between dryer cabinet and adjacent walls or other surfaces are: 0" either side; 1" front, top and rear
- Closet doors must be louvered or otherwise ventilated and must contain a minimum of 60 sq. in. of open area equally distributed. If this closet contains both a washer and a dryer, doors must contain a minimum of 120 sq. in. of open area equally distributed.
- No other fuel-burning appliance shall be installed in the same closet with a gas dryer.

BATHROOM OR BEDROOM INSTALLATION:

- The dryer **MUST** be exhausted to the outdoors.
- The installation must conform with the local codes, or in the absence of local codes, with the National Electric Code and National Fuel Gas Code, ANSI Z223 for gas dryers.

MINIMUM CLEARANCES OTHER THAN ALCOVE OR CLOSET INSTALLATION:

- Minimum clearances to combustible surfaces are: 0" both sides; 1" rear

DRYER EXHAUSTING INFORMATION:

- Use metal duct only, vertical and horizontal ducting.



For answers to your Monogram, GE Café™, GE Profile™ or GE Appliances product questions, visit our website at geappliances.com or call GE Answer Center® Service, 800.626.2000.



PTD60GBSR/BPR

GE Profile™ 7.4 cu. ft. Capacity aluminized alloy drum Gas Dryer with Sanitize Cycle and Sensor Dry

DIMENSIONS AND INSTALLATION INFORMATION (IN INCHES)

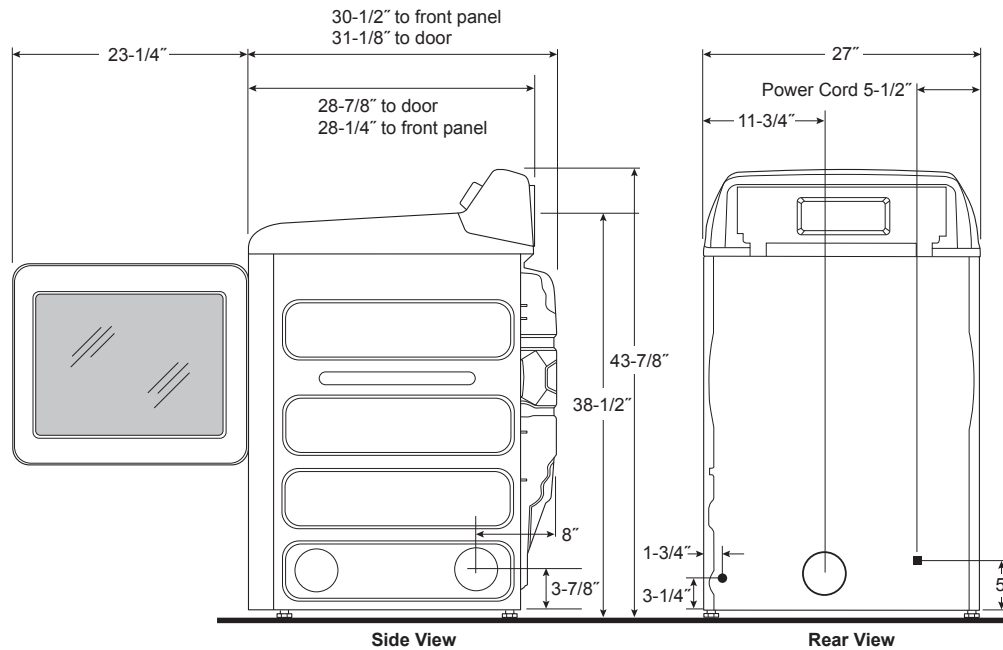

POWER CORD LOCATIONS

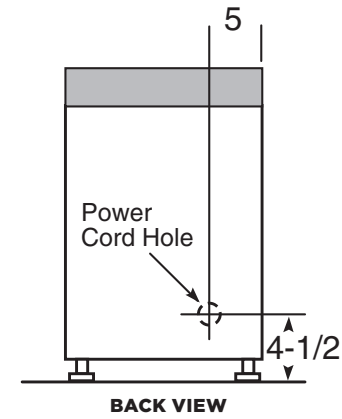

For answers to your Monogram, GE Café™, GE Profile™ or GE Appliances product questions, visit our website at geappliances.com or call GE Answer Center® Service, 800.626.2000.



PTD60GBSR/BPR

GE Profile™ 7.4 cu. ft. Capacity aluminized alloy drum Gas Dryer with Sanitize Cycle and Sensor Dry

FOR COMPLETE INFORMATION, SEE INSTALLATION INSTRUCTIONS PACKED WITH YOUR DRYER.

DUCTING MATERIALS:

For best performance, this dryer should be vented with 4" diameter all rigid metal exhaust duct. If rigid metal duct cannot be used, then UL-listed flexible metal (semi-rigid) ducting can be used (Kit WX08X10077). In special installations, it may be necessary to connect the dryer to the house vent using a flexible metal (foil-type) duct. A UL-listed flexible metal (foil-type) duct may be used **ONLY** in installations where rigid metal or flexible metal (semi-rigid) ducting cannot be used **AND** where a 4" diameter can be maintained throughout the entire length of the transition duct. Please see installation instruction packed with your dryer for complete instructions when using flexible metal (foil type) ducting.

EXHAUST LENGTH CALCULATION:

1. Determine the number of 90° turns needed for your installation. If you exhaust to the side or bottom of dryer, add one turn.
2. The maximum length of 4" rigid (aluminum or galvanized) duct which can be tolerated is shown in the table. A turn of 45° or less may be ignored. Two 45° turns within the duct length should be treated as a 90° elbow. A turn over 45° should be treated as a 90° elbow.

Dryers must be exhausted to the outside.

CAUTION: For personal safety do not terminate exhaust into a chimney, under any enclosed house floor (crawl space), or into an attic, since the accumulated lint could create a fire hazard or moisture could cause damage. Never terminate the exhaust into a common duct or plenum with a kitchen exhaust, since the combination of lint and grease could create a fire hazard.

Exhaust ducts should be terminated in a dampered wall cap to prevent back drafts, bird nesting, etc. The wall cap must also be located at least 12" above the ground or any other obstruction with the opening pointed down.

FOR MORE INFORMATION ON VENTING KITS AND ACCESSORIES, PLEASE CALL 1-800-GE-CARES.

DRYER EXHAUSTING INFORMATION— USE METAL DUCT ONLY VERTICAL AND HORIZONTAL DUCTING

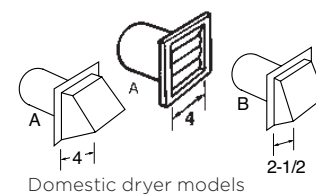

BEST PERFORMANCE		
Maximum length of 4" dia rigid metal duct		
Exhaust hood type		
Number of 90° turns	A 4" opening	B 2-1/2" opening
0	120 ft.	90 ft.
1	100 ft.	75 ft.
2	85 ft.	65 ft.
3	70 ft.	55 ft.
4	60 ft.	45 ft.
5	55 ft.	35 ft.

For every extra 90° elbow, reduce the allowable vent system length by 10 ft.
Two 45° elbows will be treated like one 90° elbow.
For the side exhaust installations, add one 90° elbow to the chart.
When calculating the total vent system length, you must add all the straight portions and elbows of the system (including the transition duct).



PTD60GBSR/BPR

GE Profile™ 7.4 cu. ft. Capacity aluminized alloy drum Gas Dryer with Sanitize Cycle and Sensor Dry

FEATURES AND BENEFITS

Washer Link – Wirelessly connects the washer to the dryer, enabling the dryer to automatically set the optimal settings based on the load that was just washed.

Wrinkle Care – Prevent wrinkles by extending the tumble without heat.

Sensor Dry – Innovative dual thermistor technology continually monitors temperature and moisture to prevent over-drying and protect your laundry.

Sanitize Cycle – Reduces 99.8% of bacteria found in laundry.

Check Vent Notification – Receive a notification when the dryer vent needs to be cleaned, ensuring safe operation and optimal drying performance.

120 ft. Venting – Innovative 120 ft. venting enables optimal airflow, enhanced drying ability and flexible installation.

Built-In WiFi Powered by SmartHQ™ – Start, stop and monitor your laundry from anywhere while receiving real-time notifications and updates.

Download Additional Cycles – Leverage the power of SmartHQ™ technology to download additional cycles, such as Warm Up, Active Wear and Casual.

My Cycle – Streamline your laundry process by saving your favorite dryer settings for future use.

Quick Dry – Quickly dries a variety of loads for families on the go.

Damp Notification – Receive a notification when your laundry has reached the ideal dampness to remove from the dryer, so you get wrinkle-free results.

Eco Dry – This dryer uses less energy and still offers reliable performance, giving you the same high-quality results.

ENERGY STAR® qualified – Meets or exceeds federal guidelines for energy efficiency for year-round energy and money savings.

Model PTD60GBSRWS – White with silver backsplash

Model PTD60GBPRDG – Diamond Gray

