

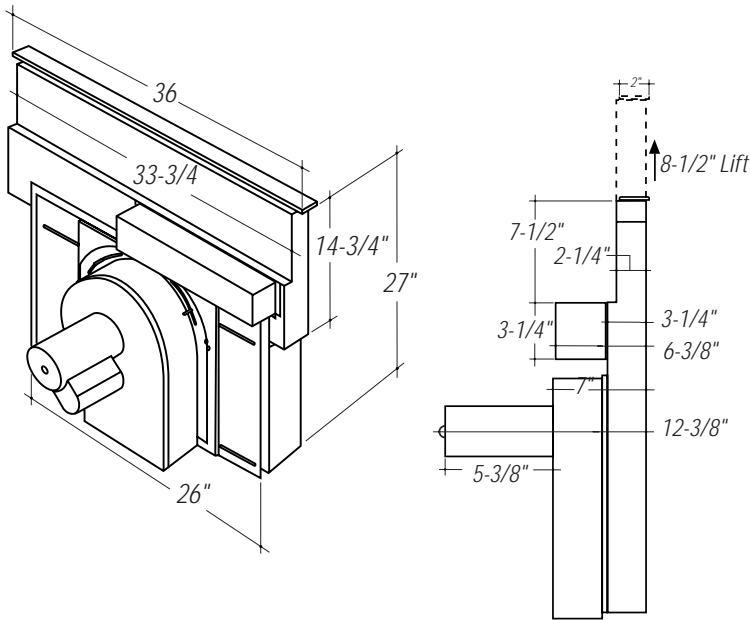

Monogram™

ZVB36SBSS—GE Monogram 36" Telescopic Downdraft Vent Hood

Dimensions (in inches)



Monogram Telescopic Downdrafts are available for both 30" and 36" gas and electric cooktops.

Important Installation Note:

The installation of these downdraft vents in combination with any Monogram Cooktop requires an extra deep countertop. The flat surface of the countertop must be deep enough, front to back, to accommodate the combined depth of the vent and the cooktop together. Additional clearances required by UL from the cutout to the front edge of the countertop also vary by model and must be considered. Be sure to review the Downdraft Vent Installation Instructions, packed with product, carefully. These instructions provide exact cutout and countertop area requirements for the installation of the vent with each specific Monogram cooktop.

Perimeter Installation with Standard Cabinet

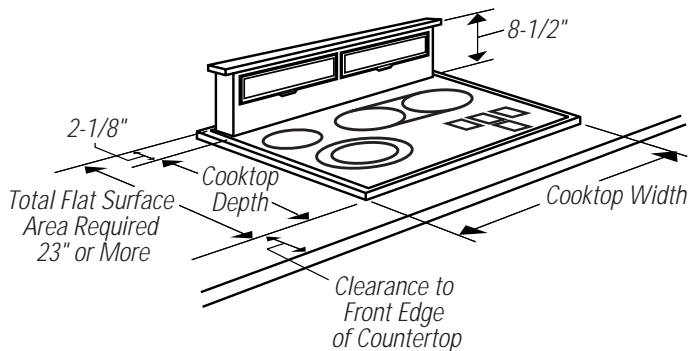

For answers to your Monogram®, GE Profile Performance Series™, GE Profile™ or GE appliance questions, call GE Answer Center® service, 800.626.2000.





Monogram™

ZVB36SBSS—GE Monogram 36" Telescopic Downdraft Vent Hood

Perimeter Installation with Sink Base Cabinet and Filler Panels

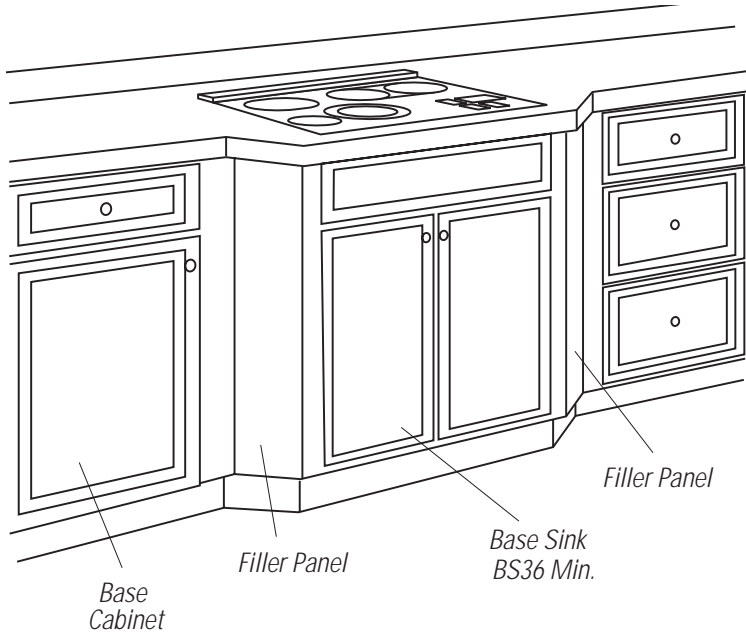

Island Installation

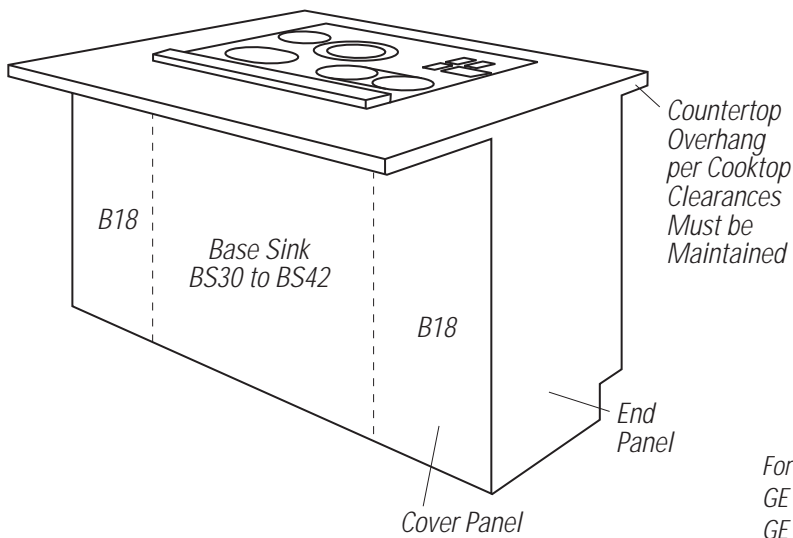

For answers to your Monogram®, GE Profile Performance Series™, GE Profile™ or GE appliance questions, call GE Answer Center® service, 800.626.2000.





Monogram™

ZVB36SBSS—GE Monogram 36" Telescopic Downdraft Vent Hood

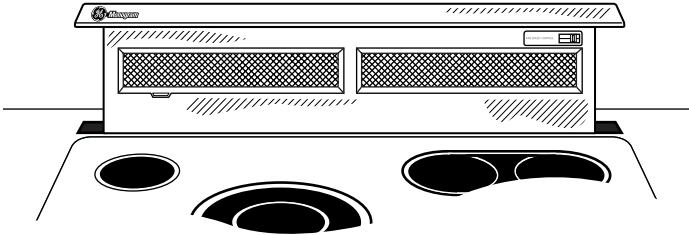

Features and Benefits

- *36" Telescopic Downdraft System*
- *500 CFM Performance*
- *Upfront Variable Speed Fan with Slide Control*
- *Raises to 8-1/2" over Cooktop Surface*
- *Retracts when not in use*
- *Removable Grease Filters*
- *3-1/4" x 10" Rectangular Duct*
- *Optional Blower Mount Capabilities*
- *Stainless Steel Vent Body*
- *Minimum 6" Round Duct Capabilities*
- *Model ZVB36WBWW—White on white*
- *Model ZVB36BBBB—Black on black*
- *Model ZVB36SBSS—Stainless steel*