

# Dishwashers

*Safety Instructions* . . . . . 2, 3

*Operating Instructions*

Care and Cleaning . . . . . 9

Control Panels . . . . . 4

Control Settings . . . . . 5

Dial Cycles . . . . . 6

Loading the Dishwasher Racks . . . . 8

Optional Accessories . . . . . 10

Using the Dishwasher . . . . . 7

*Troubleshooting Tips* . . . . . 11, 12

*Consumer Support*

Consumer Support . . . . . Back Cover

Product Registration . . . . . 13, 14

Warranty . . . . . 15

**Owner's Manual**

*HDA1000*

*HDA1200*

*HDA2000*

*HDA3400*

*HDA3700*

**Write the model and serial numbers here:**

**Model #** \_\_\_\_\_

**Serial #** \_\_\_\_\_

You can find them on a label on the tub wall just inside the door.

# IMPORTANT SAFETY INFORMATION. READ ALL INSTRUCTIONS BEFORE USING.

## **WARNING!**

*For your safety, the information in this manual must be followed to minimize the risk of fire or explosion, electric shock, or to prevent property damage, personal injury, or death.*



## WATER HEATER SAFETY

*Under certain conditions hydrogen gas may be produced in a water heater that has not been used for two weeks or more. **HYDROGEN GAS IS EXPLOSIVE.***

If the hot water has not been used for two weeks or more, prevent the possibility of damage or injury by turning on all hot water faucets and allow them to run for several minutes. Do this before using any electrical appliance which is connected to the hot water system. This simple procedure will allow any built-up hydrogen gas to escape. Since the gas is flammable, do not smoke or use an open flame or appliance during this process.

*Use this appliance only for its intended purpose as described in this Owner's Manual.*



## PROPER INSTALLATION AND MAINTENANCE

*This dishwasher must be properly installed and located in accordance with the Installation Instructions before it is used. If you did not receive an Installation Instructions sheet with your dishwasher, you can receive one by visiting our website at [Hotpoint.com](http://Hotpoint.com).*

- Connect to a grounded metal, permanent wiring system; or run an equipment-grounding conductor with the circuit conductors and connect to the equipment-grounding terminal or lead of the appliance.
- Improper connection of the equipment-grounding conductor can result in a risk of electric shock. Check with a qualified electrician or service representative if you are in doubt whether the appliance is properly grounded.
- Use supply conductors rated at least 75°C (167°F).
- Dispose of discarded appliances and shipping or packing material properly.
- Do not attempt to repair or replace any part of your dishwasher unless it is specifically recommended in this manual. All other servicing should be referred to a qualified technician.
- To minimize the possibility of electric shock, disconnect this appliance from the power supply before attempting any maintenance.  
**NOTE:** Turning the dishwasher off does not disconnect the appliance from the power supply. We recommend having a qualified technician service your appliance.

## **WARNING!**

### DO NOT...



- Do not tamper with controls.
- Do not abuse, sit on, or stand on the door or dish rack of the dishwasher.
- Do not discard a dishwasher without first removing the door of the washing compartment.
- Do not store or use combustible materials, gasoline or other flammable vapors and liquids in the vicinity of this or any other appliance.
- Do not allow children to play around dishwasher when opening or closing door due to the possibility of small fingers being pinched in door.
- Do not allow children to play with, on or around this appliance or any discarded appliance.

## **⚠ WARNING! RISK OF CHILD ENTRAPMENT**

### *PROPER DISPOSAL OF THE DISHWASHER*

Junked or abandoned dishwashers are dangerous... even if they will sit for “just a few days.” If you are getting rid of your old dishwasher, please follow the instructions below to help prevent accidents.

#### **Before You Throw Away Your Old Dishwasher:**

- Take off the door of the washing compartment or remove the door latch keeper (as shown).

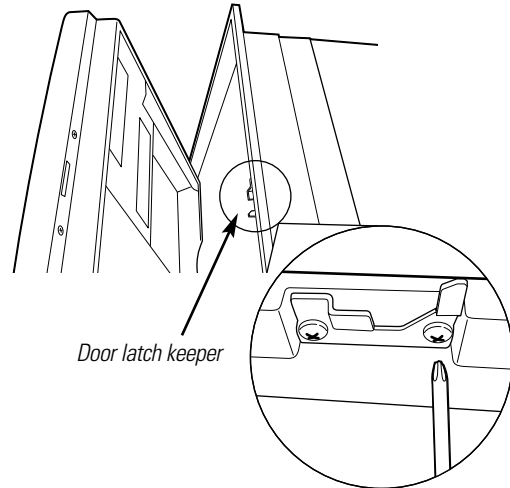

### *WHEN USING YOUR DISHWASHER*

- Use only powder, tabs, liquid detergents or rinse agents recommended for use in a dishwasher and keep them out of the reach of children. Cascade®, Cascade Complete® and Electrasol® Automatic Dishwashing Detergents, and Jet-Dry® rinse agent have been approved for use in all GE dishwashers.
- Locate sharp items so that they are not likely to damage the door seal.
- Load sharp knives with the handles up to reduce the risk of cut-type injuries.
- Do not wash plastic items unless marked *dishwasher safe* or the equivalent. For plastic items not so marked, check the manufacturer’s recommendations.
- Non-Dishware Items: Do not wash items such as electronic air cleaner filters, furnace filters and paint brushes in your dishwasher. Damage to dishwasher and discoloration or staining of dishwasher may result.
- Do not touch the heating element during or immediately after use.
- Do not operate your dishwasher unless all enclosure panels are properly in place.
- Close supervision is necessary if this appliance is used by or near children.
- Load light, plastic items so they will not become dislodged and drop to the bottom of the dishwasher—they might come into contact with the heating element and be damaged.



**READ AND FOLLOW THIS SAFETY INFORMATION CAREFULLY.**  
**SAVE THESE INSTRUCTIONS**

# About the dishwasher control panel.

You can locate your model number on the tub wall just inside the door. Throughout this manual, features and appearance may vary from your model.

## Model HDA1000

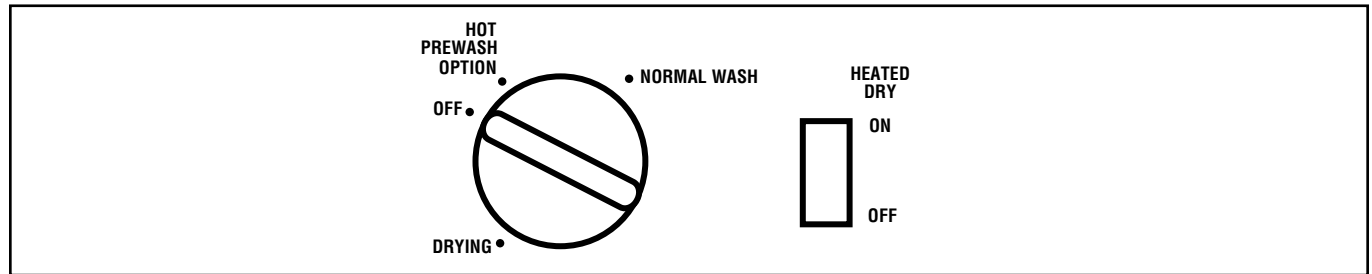

## Model HDA1200

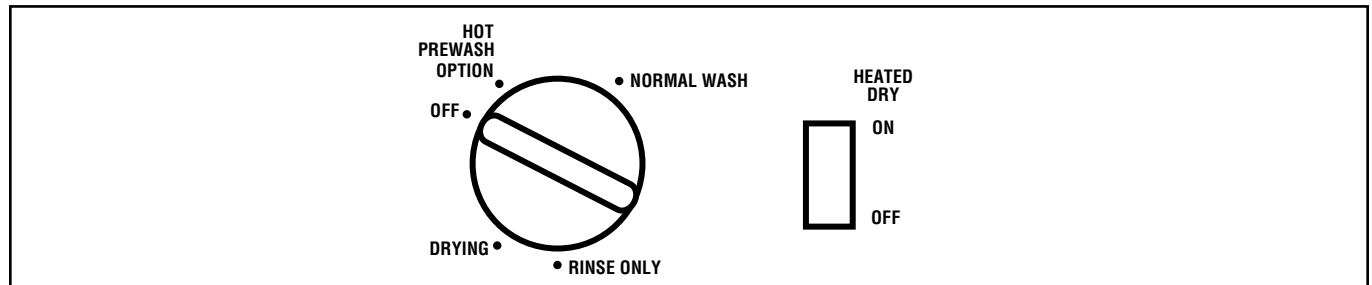

## Model HDA2000

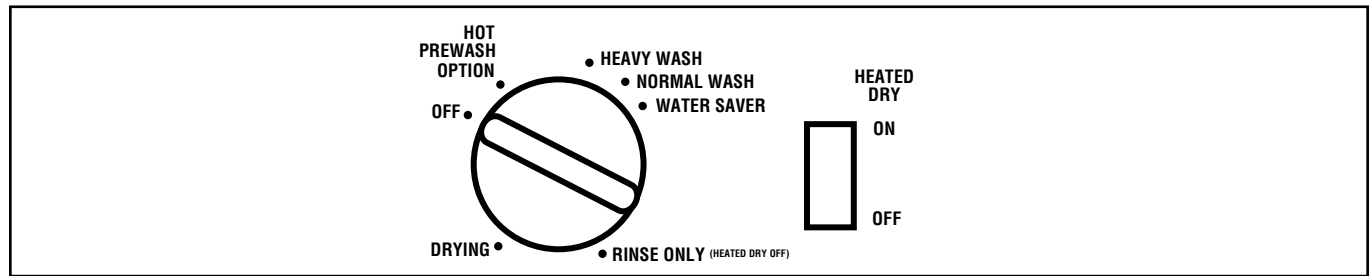

## Model HDA3400

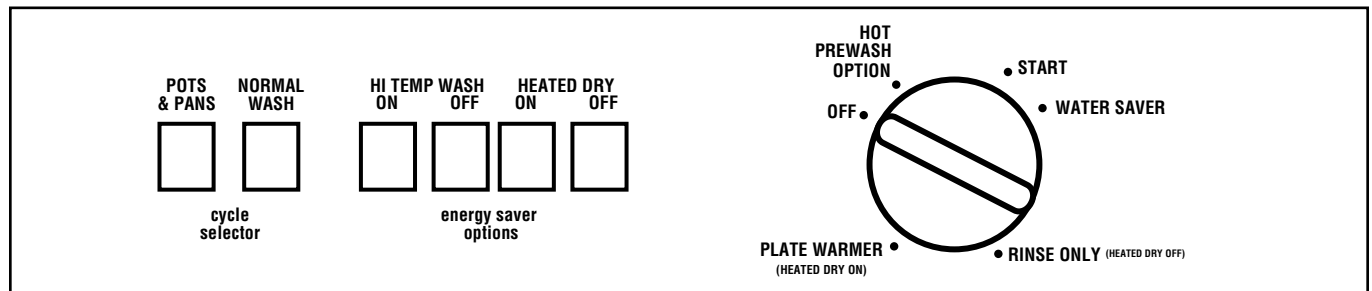

## Model HDA3700

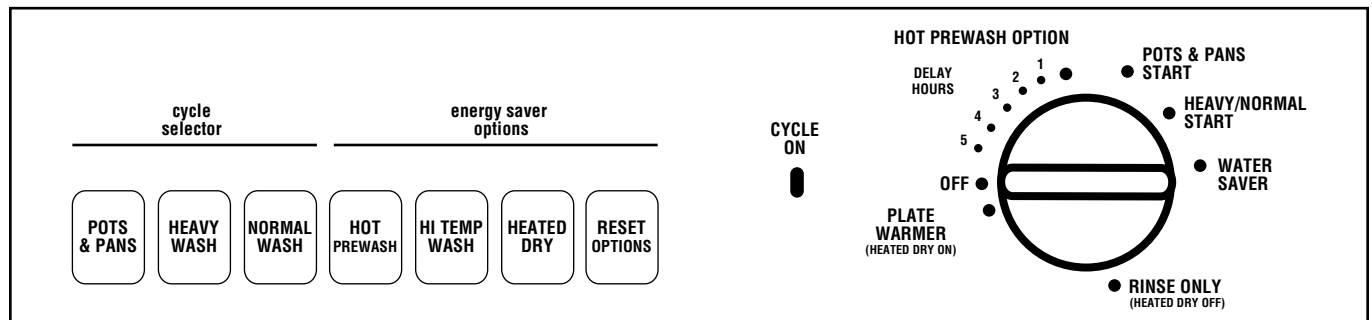

## Control Settings

### 1 Cycles

<b>POTS &amp; PANS/ HEAVY WASH</b>	For heavily soiled dishes or cookware with dried-on or baked-on soils. Everyday dishes may be included. This cycle will not remove burned-on foods.
<b>NORMAL WASH</b>	For loads of everyday dishes, glasses and cookware with medium soils. <b>NOTE:</b> Many dishes have lighter soil than normal. Choosing a cycle other than <b>NORMAL WASH</b> will save energy and water.
<b>SHORT WASH</b>	For quickly washing loads of everyday dishes with medium soils that have not dried on, such as loads consisting mostly of glasses.
<b>WATER SAVER</b>	For dishes with light soils.
<b>RINSE ONLY</b>	For rinsing partial loads that will be washed later. <i>Do not use detergent.</i>
<b>PLATE WARMER</b>	For warming clean dishes and serving plates. This cycle will take approximately 30 minutes.
<b>HOT PREWASH</b>	Preheats wash water to the correct temperature. Adds 1.5 gal. and 30 min. RINSE to the start of the selected cycle.

### 2 Energy Options

<b>HI TEMP WASH ON/ HI TEMP WASH</b>	Provides extra heat for best performance. It is used best with heavily-soiled dishes.
<b>HI TEMP WASH OFF</b>	Turns <b>HI TEMP WASH</b> off.
<b>HEATED DRY/ HEATED DRY ON</b>	Turns the heating element on for fast drying. This option will extend the time of your wash cycle. Available on all wash cycles except <b>RINSE ONLY</b> . Adds approx. 32 minutes to the cycle.
<b>HEATED DRY OFF</b>	Turns <b>HEATED DRY</b> off. Dishes air dry naturally and energy is saved.

### 3 Start

Slowly turn the Dial to the **START** or **ON** position, or the selected cycle. Don't turn it past the **START**, **ON** or cycle position, or you could accidentally miss a rinse.

There is a time delay between start-up and water fill so you will not hear any wash action right away.

■ Latch the door to begin the cycle.

### Cycle Chart

Model	Cycle	Water Usage (gal.)	Cycle Time (min.)
HDA1000	Hot PreWash Option	3.4	26
	Normal Wash	8.4	71
	Drying/Plate Warmer	0.0	30
HDA1200	Hot PreWash Option	3.4	26
	Normal Wash	8.4	71
	Rinse Only	3.9	13
	Drying/Plate Warmer	0.0	30
HDA2000	Hot PreWash Option	3.4	26
	Heavy Wash	9.2	71
	Normal Wash	6.5	62
	Water Saver	5.2	58
	Rinse Only	3.9	13
	Drying/Plate Warmer	0.0	27
HDA3400	Hot PreWash Option	3.4	26
	Heavy Wash	9.2	71
	Normal Wash*	6.3	71
	Water Saver*	5.0	62
	Rinse Only*	2.5	13
	Drying/Plate Warmer	0.0	27
HDA3700	Hot PreWash Option	1.7	31
	Pots & Pans	9.0	66
	Heavy Wash	7.7	62
	Normal Wash*	6.3	62
	Water Saver*	5.0	58
	Rinse Only*	2.5	14
	Drying/Plate Warmer	0.0	29

\* Normal cycle needs to be selected.

## About the dial cycles.

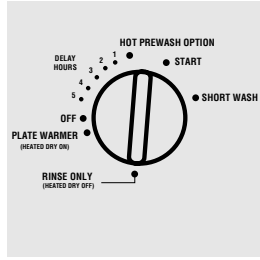

### Rinse Only

For rinsing partial loads that will be washed later. *Do not use detergent.*

- 1 Make sure **ENERGY SAVER / HEATED DRY OFF** is selected.
- 2 Be sure the door is unlatched.
- 3 Slowly turn the Dial to **RINSE ONLY**.
- 4 Latch the door to start the cycle.

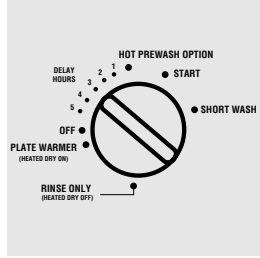

### Delayed Start

The **HOURS DELAY** will allow you to delay the start time of any cycle not on the Dial automatically for up to 6 hours.

- 1 Be sure the door is unlatched.
- 2 Select the wash cycle and option you want.
- 3 Slowly turn the Dial to desired time. The **DELAYED START** light will come on.
- 4 Latch the door to start the cycle.

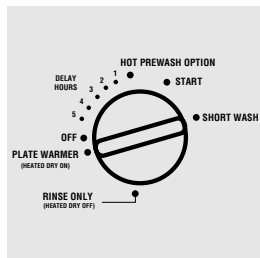

### Plate Warmer

For warming clean dishes and serving plates. This cycle will take approximately 32 minutes.

- 1 Load clean dishware to be warmed.
- 2 Select **HEATED DRY / HEATED DRY ON**.
- 3 Be sure the door is unlatched.
- 4 Slowly turn the Dial to **PLATE WARMER**.
- 5 Latch the door to start the cycle.

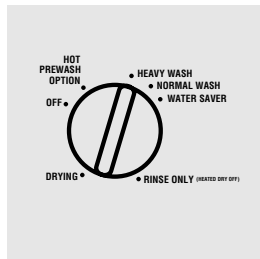

### Heavy, Normal or Water Saver

- 1 Be sure the door is unlatched.
- 2 Slowly turn the Dial to the cycle you want. Don't turn it past this position, or you could accidentally miss a rinse.
- 3 Select any options.
- 4 Latch the door to start the cycle.

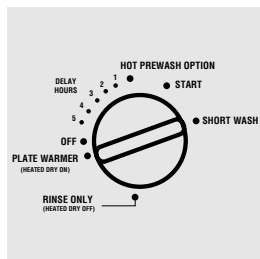

### Short Wash

For quickly washing loads of everyday dishes with medium soils that have not dried on.

- 1 Be sure the door is unlatched.
- 2 Slowly turn the Dial to **SHORT WASH**.
- 3 Latch the door to start the cycle.



## Check the Water Temperature

The entering water must be at least 120°F. and not more than 150°F., for effective cleaning and to prevent dish damage. Check the water temperature with a candy or meat thermometer.

Turn on the hot water faucet nearest the dishwasher; place the thermometer in a glass and let the water run continuously into the glass until the temperature stops rising.



## Use Jet-Dry® Rinse Agent

**Jet-Dry®** rinse agent removes spots and prevents new film build-up on your dishes, glasses, flatware, cookware and plastic.

### Filling the Dispenser

Fill the rinse agent dispenser until it reaches the bottom of lip inside the opening. Replace cap.

To check if rinse agent is needed, remove the cap and look into the dispenser.

*A full dispenser should last about one month.*

*If rinse agent spills, wipe up the excess.*

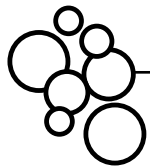
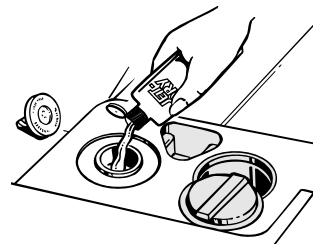

## Proper Use of Detergent

Use only detergent specifically made for use in dishwashers. Cascade®, Cascade® Complete and Electrasol® Automatic Dishwashing Detergents have been approved for use in all GE dishwashers. Keep your detergent fresh and dry. Don't put powder detergent into the dispenser until you're ready to wash dishes.

The amount of detergent to use depends on whether your water is *hard* or *soft*. With hard water, you need extra detergent. With soft water, you need less detergent.

Protect your dishes and dishwasher by contacting your water department and asking how hard your water is. Twelve or more grains is extremely hard water. A water softener is recommended. Without it, lime can build up in the water valve, which could stick while open and cause flooding. Too much detergent with soft water can cause a permanent cloudiness of glassware, called *etching*.

You'll find two detergent dispensers on the inside door of your dishwasher. All wash cycles require detergent in the main cup. Wash cycles with two washes will also use the open cup. When using automatic dishwashing detergent tabs, simply place one tab in the main cup and close.

Be sure the Dial is **OFF** before adding detergent. Otherwise, the detergent cup will not close and latch properly. Add detergent then close the main cup.

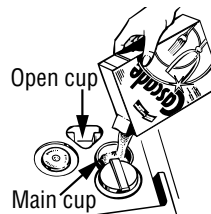

**NOTE:** To open detergent cup after it has been closed, simply turn the detergent cup handle counterclockwise until it releases. A snapping sound may be heard.



## Forget to Add a Dish?

A forgotten dish can be added any time before the main wash.

- 1 Push the door latch to the left.
- 2 Once the water calms, open the door. Steam may rise out of the dishwasher.
- 3 Add forgotten dishes.
- 4 Close the door and push the latch to the far right.

## Loading the dishwasher racks.

For best dishwashing results, follow these loading guidelines. Features and appearance of racks and silverware baskets may vary from your model.

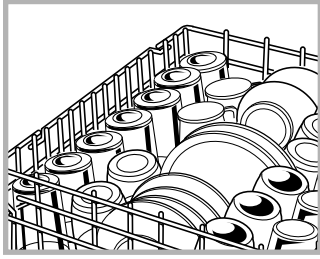

### Upper Rack

The upper rack is for glasses, cups and saucers. Cups and glasses fit best along the sides. This is also a secure place for dishwasher-safe plastics. The upper rack is good for all kinds of odd-shaped utensils. Saucepans, mixing bowls and other items should be placed face down.

Secure larger dishwasher-safe plastics over two fingers when possible.

Make sure small plastic items are secure so they can't fall onto the heating element.

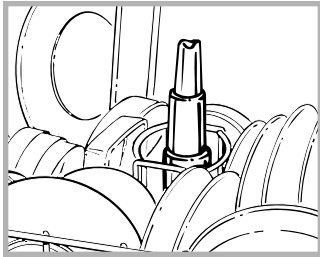

### Wash Tower

Keep the center area clear in the lower rack.

The wash tower rises through the center of the lower rack during the wash and rinse portions of the cycle.



Don't block it or load tall things next to it.

Also, be careful not to let a portion of an item such as a pot or dish handle extend through the bottom rack. This could block the wash arm and cause poor washing results.

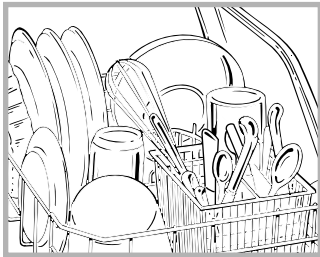

### Lower Rack

When loading the lower rack, do not load large platters or trays in the front right corner. They may prevent detergent from circulating during the wash cycle.

The lower rack is best used for plates, saucers, and cookware. Large items such as broiler pans and racks should go along the sides. Load platters, pots and bowls along the sides, in corners, or in the back. The soiled side of items should face the center of the rack.



### Silverware Basket

Put flatware in the removable basket with fork and knife handles up to protect your hands. Place spoons in the basket with handles down. Mix knives, forks and spoons so they don't nest together. Distribute evenly. Small plastic items, such as measuring spoons and lids from small containers, should go in the bottom of the silverware basket with silverware on top.



Don't let any item extend through bottom.



A security cell cover (on some models) can be lowered to either side to secure lightweight items from the effects of the vigorous wash action.



# Caring for the dishwasher.

Hotpoint.com

To clean the control panel use a lightly dampened cloth then dry thoroughly. To clean the exterior use a good appliance polish.

Never use sharp object, scouring pads or harsh cleaners on any part of the dishwasher.

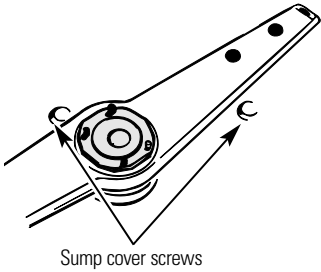

## Protect Against Freezing

If your dishwasher is left in an unheated place during the winter, ask a service technician to:

- 1 Cut off electrical power to the dishwasher. Remove fuses or trip circuit breaker.
- 2 Turn off the water supply and disconnect the water inlet line from the water valve.
- 3 Drain water from the inlet line and water valve. (Use a pan to catch the water.)
- 4 Reconnect the water inlet line to the water valve.
- 5 Remove the plastic sump cover in the tub bottom and use a sponge to soak up water in the rubber boot.

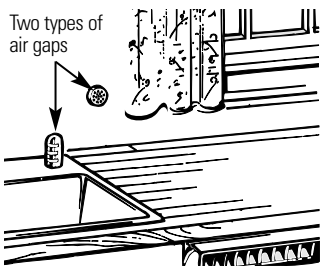

## Does Your Dishwasher Have an Air Gap?

An air gap protects your dishwasher against water backing up into it if a drain clogs. The air gap is not a part of the dishwasher. It is not covered by your warranty. Not all plumbing codes require air gaps, so you may not have one.

### The air gap is easy to clean.

- 1 Turn off the dishwasher and lift off the chrome cover.
- 2 Unscrew the plastic cap and clean with a toothpick.

Check the air gap any time your dishwasher isn't draining well.

## About optional accessories.

You can change the door and lower access panel appearance of your dishwasher by ordering one of these optional accessories:

- Color Panels
- 1/4" Wood Panel Trim Kit
- 3/4" Trimless Wood Panel Kit

These accessories are available at extra cost (VISA, MasterCard, or Discover cards accepted) by calling 800.626.2002.

Specify accessory number when ordering.



### Descriptions of Optional Accessories

**Wood panel trim kit**— This accessory contains *trim and instructions* for you to supply and install a 1/4" thick decorative wood door and lower access panel.

For models:

**HDA1000/HDA2000/HDA3400**

- GPF325A (Almond)
- GPF325B (Black)
- GPF325C (Bisque)
- GPF325W (White)

**HDA3700**

- GPF425A (Almond)
- GPF425B (Black)
- GPF425C (Bisque)
- GPF425W (White)

**NOTE:** The GPF100 dishwasher door spring kit must also be ordered and installed *when the door panel weighs four lbs. or more.*

**Trimless wood panel kit**— This accessory contains *parts and instructions* for you to supply and install a 3/4" thick decorative wood door and lower access panel.

For models:

**HDA1000/HDA2000/HDA3400**

- GPF375

**HDA3700**

- GPF475

**NOTE:** The GPF100 dishwasher door spring kit will be included with the *trimless wood panel kit* and must be installed with it.

## About rack accessories.

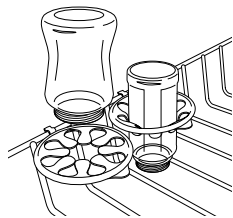

For best results, the Baby Bottle Holder should be installed on the upper rack of the dishwasher.

**Baby Bottle Holder**  
**Part Number: WX69X200**

- Prevents movement of baby bottles during the dishwasher cycle
- Snaps easily onto any dishwasher upper rack
- Eliminates hand washing
- Fits all baby bottles

You can order a package of 5 Baby Bottle Holders, at extra cost, by calling 800.626.2002, or through the Internet at [GEAppliances.com](http://GEAppliances.com) (Visa, MasterCard or Discover cards accepted).



**Troubleshooting Tips**  
 Save time and money! Review the charts on the following pages, or visit [Hotpoint.com](http://Hotpoint.com). You may not need to call for service.

<b>Problem</b>	<b>Possible Causes</b>	<b>What To Do</b>
<b>Dishwasher won't run</b>	Fuse is blown, or the circuit breaker tripped	<ul style="list-style-type: none"> <li>• Replace fuse or reset circuit breaker. Remove any other appliances from the circuit.</li> </ul>
<b>Noise</b>	Some of the sounds you'll hear are normal	<ul style="list-style-type: none"> <li>• Soft food disposal shredding action.</li> <li>• Drain valve opening to pump water out.</li> <li>• Timer control as cycle progresses.</li> <li>• Detergent cup opening.</li> <li>• The motor stopping during the drying period.</li> </ul>
	Utensils are not secure in the rack or something small has dropped into the rack	<ul style="list-style-type: none"> <li>• Make sure everything is secured in dishwasher.</li> </ul>
	Motor hums	<ul style="list-style-type: none"> <li>• Dishwasher has not been used on a regular basis. If you do not use your dishwasher often, set it to fill and pump out once every week. This will help keep the seal moist and the garbage disposer clear.</li> </ul>
<b>Water standing in the bottom of the tub</b>	This is normal	<ul style="list-style-type: none"> <li>• A small amount of clean water around the outlet on the tub bottom at the back of the tub keeps the water seal lubricated.</li> </ul>
<b>Water won't pump out of the tub</b>	Drain is clogged	<ul style="list-style-type: none"> <li>• If you have an air gap, clean it.</li> <li>• Check to see if your kitchen sink is draining well. If not, you may need a plumber.</li> <li>• If the dishwasher drains into a disposer, run disposer clear.</li> </ul>
<b>Suds in the tub</b>	Correct detergent wasn't used	<ul style="list-style-type: none"> <li>• Use only automatic dishwasher detergents to avoid sudsing. Cascade®, Cascade® Complete and Electrasol® Automatic Dishwashing Detergents have been approved for use in all GE dishwashers.</li> <li>• To remove suds from the tub, open the dishwasher and let suds evaporate. Add 1 gallon of cold water to the tub. Close and latch the dishwasher. Pump out water by slowly turning the Dial until a drain period is reached. Repeat if necessary.</li> </ul>
	Rinse agent was spilled	<ul style="list-style-type: none"> <li>• Always wipe up rinse agent spills immediately.</li> </ul>
<b>Stained tub interior</b>	Detergent with colorant was used	<ul style="list-style-type: none"> <li>• Some detergents contain colorant (pigment or dyes) that will discolor the tub interior with extended use. Check the detergent cup for signs of any discoloration. If cup is discolored, change to detergent without any colorant. Cascade®, Cascade® Complete and Electrasol® Automatic Dishwashing Detergents have been approved for use in all GE dishwashers.</li> </ul>
	Some tomato-based foods can stain	<ul style="list-style-type: none"> <li>• Use of the <b>RINSE ONLY</b> cycle (on some models) after adding the dish to the load can decrease the level of staining.</li> </ul>
<b>Dishes don't dry</b>	Low inlet water temperature	<ul style="list-style-type: none"> <li>• Make sure inlet water temperature is correct.</li> </ul>
	Rinse agent dispenser is empty	<ul style="list-style-type: none"> <li>• Check the rinse agent dispenser.</li> </ul>

## Before you call for service...

### Safety Instructions

Problem	Possible Causes	What To Do
<b>Dishes and flatware not clean</b>	Inlet water temperature is below 120°F.	<ul style="list-style-type: none"> <li>• Raise the water heater temperature to 120°F.</li> <li>• Use the <b>HOT PREWASH</b> feature.</li> </ul>
	Water pressure is temporarily low	<ul style="list-style-type: none"> <li>• Turn on a faucet. Is water coming out more slowly than usual? If so, wait until pressure is normal before using your dishwasher.</li> </ul>
	Air gap is clogged	<ul style="list-style-type: none"> <li>• Clean the air gap.</li> </ul>
	Improper rack loading	<ul style="list-style-type: none"> <li>• Make sure large dishware does not block the detergent dispenser or the wash arm.</li> </ul>

### Operating Instructions

<b>Spots and filming on glasses and flatware</b>	Extremely hard water	<ul style="list-style-type: none"> <li>• Use <b>Jet-Dry®</b> rinse agent to remove spots and prevent new film build-up.</li> </ul>
	Low inlet water temperature	<ul style="list-style-type: none"> <li>• To remove stubborn spots and pre-existing film from glassware:               <ol style="list-style-type: none"> <li>1 Remove all metal utensils from the dishwasher.</li> <li>2 Do not add detergent.</li> <li>3 Select the longest cycle.</li> <li>4 Start the dishwasher and allow to run for 18 to 22 minutes. Dishwasher will now be in the main wash.</li> <li>5 Open the door and pour 2 cups (500 ml) of white vinegar into the bottom of the dishwasher.</li> <li>6 Close the door and allow to complete the cycle. If vinegar rinse doesn't work: Repeat as above, except use 1/4 cup (60 ml) of citric acid crystals instead of vinegar.</li> </ol> </li> </ul>
	Overloading the dishwasher	
	Improper loading	
	Old or damp powder detergent	
	Rinse agent dispenser empty	
Too little detergent		

<b>Cloudiness on glassware</b>	Combination of soft water and too much detergent	<ul style="list-style-type: none"> <li>• This is called <i>etching</i> and is permanent. To prevent this from happening, use less detergent if you have soft water. Wash glassware in the shortest cycle that will get them clean.</li> </ul>
	Water temperature entering the dishwasher exceeds 150°F.	<ul style="list-style-type: none"> <li>• Lower the water heater temperature.</li> </ul>

<b>Yellow or brown film on tub</b>	Tea or coffee stains	<ul style="list-style-type: none"> <li>• Remove the stain by hand, using a solution of 1/2 cup bleach and 3 cups warm water.</li> </ul> <p><b>▲ WARNING</b> Before cleaning interior, wait at least 20 minutes after a cycle for the heating element to cool down. Failure to do so can result in burns.</p>
	An overall yellow or brown film can be caused by iron deposits in water	<ul style="list-style-type: none"> <li>• A special filter in the water supply line is the only way to correct this problem. Contact a water softener company.</li> </ul>

<b>White film on inside surfaces</b>	Hard water minerals	<ul style="list-style-type: none"> <li>• To clean the interior, apply dishwasher detergent to a damp sponge. Wear rubber gloves. <b>Do not</b> use any type of cleanser other than dishwasher detergent because it may cause foaming or sudsing. Cascade®, Cascade® Complete and Electrasol® Dishwashing Detergents have been approved for use in all GE dishwashers.</li> </ul>
--------------------------------------	---------------------	--

<b>Detergent cup lid won't latch</b>	Dial is not in the <b>OFF</b> position	<ul style="list-style-type: none"> <li>• Turn the Dial to <b>OFF</b> and slide the door latch to the left.</li> </ul>
<b>Detergent left in dispenser cups</b>	Dishes are blocking the detergent cups	<ul style="list-style-type: none"> <li>• Reposition the dishes.</li> </ul>
<b>Steam</b>	This is normal	<ul style="list-style-type: none"> <li>• Steam comes through the vent by the door latch during drying and when water is being pumped out.</li> </ul>

<b>Black or gray marks on dishes</b>	Aluminum utensils have rubbed against dishes	<ul style="list-style-type: none"> <li>• Remove marks with a mild, abrasive cleaner.</li> </ul>
--------------------------------------	--	---

### Troubleshooting Tips

### Consumer Support

## GE Service Protection Plus™

GE, a name recognized worldwide for quality and dependability, offers you Service Protection Plus™—comprehensive protection on all your appliances—**No Matter What Brand!**

**Benefits Include:**

- Backed by GE
- All brands covered
- Unlimited service calls
- All parts and labor costs included
- No out-of-pocket expenses
- No hidden deductibles
- One 800 number to call

***We'll Cover Any Appliance.  
Anywhere. Anytime.\****

You will be completely satisfied with our service protection or you may request your money back on the remaining value of your contract. No questions asked. It's that simple.

Protect your refrigerator, dishwasher, washer and dryer, range, TV, VCR and much more—**any brand!** Plus there's no extra charge for emergency service and low monthly financing is available. Even icemaker coverage and food spoilage protection is offered. You can rest easy, knowing that all your valuable household products are protected against expensive repairs.

Place your confidence in GE and call us in the U.S. toll-free at **800.626.2224** for more information.

\*All brands covered, up to 20 years old, in the continental U.S.

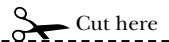

Please place in envelope and mail to:

***General Electric Company***  
**Warranty Registration Department**  
**P.O. Box 32150**  
**Louisville, KY 40232-2150**

# Consumer Product Ownership Registration

Dear Customer:

Thank you for purchasing our product and thank you for placing your confidence in us. We are proud to have you as a customer!

Follow these three steps to protect your new appliance investment:

# 1

Complete and mail your **Consumer Product Ownership Registration** today. Have the peace of mind of knowing we can contact you in the unlikely event of a safety modification.

# 2

After mailing the registration below, store this document in a safe place. It contains information you will need should you require service. Our service number is 800.GE.CARES (800.432.2737).

# 3

Read your Owner's Manual carefully. It will help you operate your new appliance properly.

Model Number

Serial Number



**Important: If you did not get a registration card with your product, detach and return the form below to ensure that your product is registered, or register online at [Hotpoint.com](http://Hotpoint.com).**

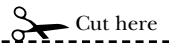

## Consumer Product Ownership Registration



Model Number

Serial Number



Mr.  Ms.  Mrs.  Miss

First Name

Last Name

Street Address

Apt. #

E-mail Address\*

City

State

Zip Code

Date Placed In Use Month

Day

Year

Phone Number  -  -

\* Please provide your e-mail address to receive, via e-mail, discounts, special offers and other important communications from GE Appliances (GEA).

Check here if you do not want to receive communications from GEA's carefully selected partners.



GE Appliances

**HOTPOINT**

General Electric Company  
Louisville, Kentucky  
GEAppliances.com

# Hotpoint Dishwasher Warranty.



All warranty service provided by our Factory Service Centers, or an authorized Customer Care<sup>®</sup> technician. To schedule service, on-line, 24 hours a day, visit us at [GEAppliances.com](http://GEAppliances.com), or call 800.GE.CARES (800.432.2737).

Staple your receipt here.  
Proof of the original purchase date is needed to obtain service under the warranty.

## For The Period Of: GE Will Replace:

### One Year

From the date of the original purchase

**Any part** of the dishwasher which fails due to a defect in materials or workmanship. During this **full one-year warranty**, GE will also provide, **free of charge**, all labor and in-home service to replace the defective part.

### Second Year (Only for models HDA2000, HDA3400, and HDA3700)

From the date of the original purchase

**Any part** of the **Water Distribution System** which fails due to a defect in materials or workmanship. Associated inlet and drain plumbing parts are not covered by this warranty. During this **second-year limited warranty**, you will be responsible for any labor or in-home service costs.

### Ten Years (Only for models HDA2000, HDA3400 and HDA3700)

From the date of the original purchase

**The PermaTuf<sup>®</sup> tub or door liner**, if it fails to contain water due to a defect in materials or workmanship. During this **full warranty**, GE will also provide, **free of charge**, all labor and in-home service to replace the defective part.

## What Is Not Covered:

- Service trips to your home to teach you how to use the product.
- Improper installation.
- Failure of the product if it is abused, misused, or used for other than the intended purpose or used commercially.
- Replacement of house fuses or resetting of circuit breakers.
- Damage to the product caused by accident, fire, floods or acts of God.
- Incidental or consequential damage caused by possible defects with this appliance.
- Cleaning or servicing of the air gap device in the drain line.

*This warranty is extended to the original purchaser and any succeeding owner for products purchased for home use within the USA. In Alaska, the warranty excludes the cost of shipping or service calls to your home.*

*Some states do not allow the exclusion or limitation of incidental or consequential damages. This warranty gives you specific legal rights, and you may also have other rights which vary from state to state. To know what your legal rights are, consult your local or state consumer affairs office or your state's Attorney General.*

**Warrantor: General Electric Company, Louisville, KY 40225**

## Consumer Support.

---



### Hotpoint Website

**Hotpoint.com**

Have a question or need assistance with your appliance? Try the Hotpoint Website 24 hours a day, any day of the year! You can also shop for more great Hotpoint products and take advantage of all of our on-line support services designed for your convenience.



### Schedule Service

**Hotpoint.com**

Expert Hotpoint repair service is only one step away from your door. Get on-line and schedule your service at your convenience 24 hours any day of the year! Or call 800.GE.CARES (800.432.2737) during normal business hours.



### Real Life Design Studio

**GEAppliances.com**

GE supports the Universal Design concept—products, services and environments that can be used by people of all ages, sizes and capabilities. We recognize the need to design for a wide range of physical and mental abilities and impairments. For details of GE's Universal Design applications, including kitchen design ideas for people with disabilities, check out our Website today. For the hearing impaired, please call 800.TDD.GEAC (800.833.4322).



### Extended Warranties

**GEAppliances.com**

Purchase a Hotpoint extended warranty and learn about special discounts that are available while your warranty is still in effect. You can purchase it on-line anytime, or call 800.626.2224 during normal business hours. Hotpoint Consumer Home Services will still be there after your warranty expires.

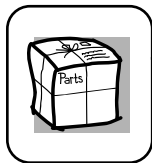

### Parts and Accessories

**Hotpoint.com**

Individuals qualified to service their own appliances can have parts or accessories sent directly to their homes (VISA, MasterCard and Discover cards are accepted). Order on-line today, 24 hours every day or by phone at 800.626.2002 during normal business hours.

**Instructions contained in this manual cover procedures to be performed by any user. Other servicing generally should be referred to qualified service personnel. Caution must be exercised, since improper servicing may cause unsafe operation.**

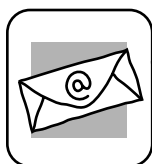

### Contact Us

**Hotpoint.com**

If you are not satisfied with the service you receive from Hotpoint, contact us on our Website with all the details including your phone number, or write to: General Manager, Customer Relations  
Hotpoint, Appliance Park  
Louisville, KY 40225



### Register Your Appliance

**Hotpoint.com**

Register your new appliance on-line—at your convenience! Timely product registration will allow for enhanced communication and prompt service under the terms of your warranty, should the need arise. You may also mail in the pre-printed registration card included in the packing material, or detach and use the form in this Owner's Manual.



Printed in the United States  
Printed on Recycled Paper