



Monogram®

ZIFI240PII – GE Monogram Fresh-Food Refrigerator Module (Custom panel required)

ZIFS240PSS – GE Monogram Fresh-Food Refrigerator Module (Stainless steel)

Dimensions and Specifications (in inches)

Installation Space

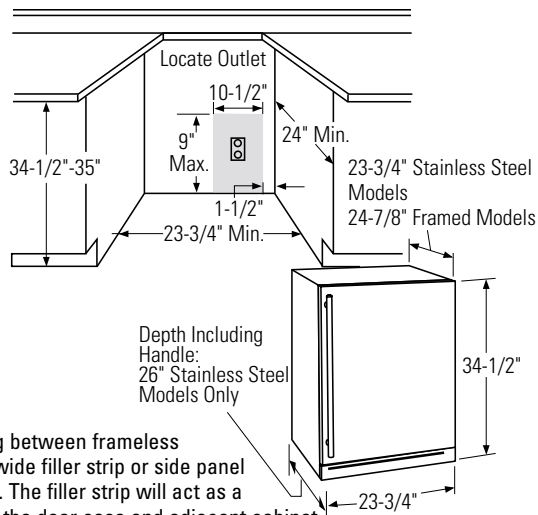

Note: If installing between frameless cabinets, a 1/2" wide filler strip or side panel may be required. The filler strip will act as a spacer between the door case and adjacent cabinet and will prevent interference with cabinet door swing. The width of the opening must include filler panels.

The cutout depth must be 24"

The cutout dimensions shown allow for a full door swing and access to the pull-out racks when installed as a built-in.

- The Fresh-Food Refrigerator can be free-standing.
- The stainless steel model ZIFS240PSS can be installed flush with standard cabinetry. ZIFI240PII with custom panel will project forward 1-3/4" of adjacent 24" deep base cabinets.
- **Note:** Door swing is not reversible.

Additional Specifications:

- A 120 volt 60Hz., 15 or 20 amp power supply is required. An individual property grounded branch circuit or circuit breaker is recommended. Install a properly grounded 3-prong electrical receptacle recessed into the back wall as shown. Electrical must be located on rear wall as shown. **Note:** GFI (ground fault interrupter) is not recommended.

Product Clearances

Models with a Custom Door Panel

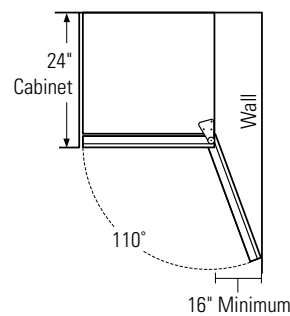

Stainless Steel Models

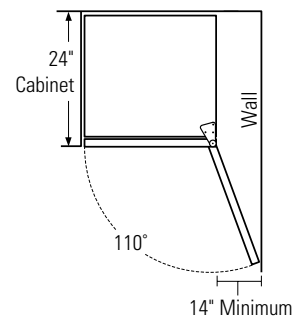

All models are factory set for a 110° door swing.

For a minimum 90° door swing:

- Allow 4" min. clearance to wall on the hinge side for Stainless Steel models.
- Allow 4-1/2" min. clearance to wall on the hinge side for models with a custom panel and custom handle.

For a full 110° door swing:

- Allow 14" min. clearance to wall on the hinge side for Stainless Steel models.
- Allow 16" min. clearance to wall on the hinge side for models with a custom panel and custom handle.



Listed by
Underwriters
Laboratories

For answers to your Monogram®, GE Profile™ or GE® appliance questions, visit our website at GEAppliances.com or call GE Answer Center® service, 800.626.2000.



Monogram®

ZIF1240PII – GE Monogram Fresh-Food Refrigerator Module (Custom panel required)

ZIFS240PSS – GE Monogram Fresh-Food Refrigerator Module (Stainless steel)

Dimensions and Specifications (in inches)

For a complete food storage center, install two Monogram refrigeration modules side-by-side.

Note: Reversible door swing on wine chillers/reserves and beverage centers only. See below for combination cutout dimensions.

Important Note: Products must operate from separate, properly grounded receptacles.

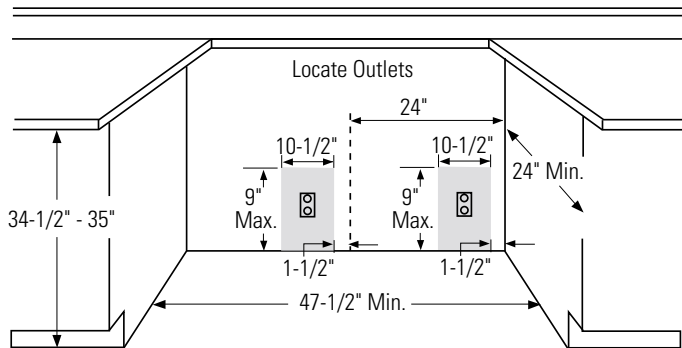

Note: Additional cutout width may be required for models with custom panels.

Grounding the Fresh-Food Refrigerator

IMPORTANT – (Please read carefully)

FOR PERSONAL SAFETY, THIS APPLIANCE MUST BE PROPERLY GROUNDED.

The power cord of this appliance is equipped with a 3-prong (grounding) plug which mates with a standard 3-prong (grounding) wall receptacle to minimize the possibility of electric shock hazard from this appliance.

Have the wall outlet and circuit checked by a qualified electrician to make sure the outlet is properly grounded.

When a standard 2-prong wall outlet is encountered, it is your personal responsibility and obligation to have it replaced with a properly grounded 3-prong wall out.

DO NOT, UNDER ANY CIRCUMSTANCES, CUT OR REMOVE THE THIRD (GROUND) PRONG FROM THE POWER CORD.

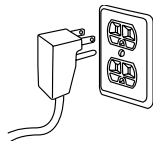

DO NOT USE AN ADAPTER PLUG TO CONNECT THE REFRIGERATOR TO A 2-PRONG OUTLET.

DO NOT USE AN EXTENSION CORD WITH THIS APPLIANCE.

Specification Created 3/04

120032

3/4" Overlay Panel Dimensions

Model ZIF1240PII requires customer-provided overlay door panel.

- The overlay panel must be secured to a 1/4" thick backer panel which slides into the trim. A .10" thick spacer panel must be placed between the custom and backer panel.
- A custom handle of your choice, supplied by your cabinet maker, must be installed on the overlay panel.

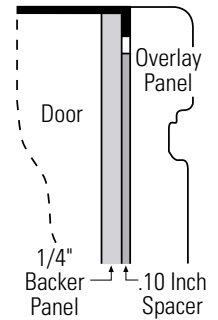

Use a 3/4" router bit to cut a notch into the **back** side of the assembled panel to allow for hinge clearance.

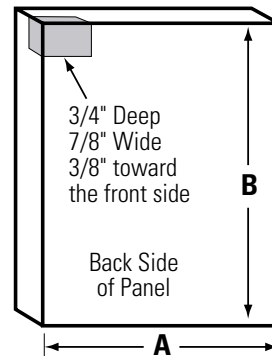

3/4" Overlay Panel Dimensions (in inches)

	A (Width)	B (Height)
1/4" Backer	23-3/16"	29-9/16"
0.10" Spacer	22-1/2"	29-1/16"
3/4" Overlay	23-5/8"	30"

NOTE: Max. assembled drawer panel weight is 25 lbs.

Assemble overlay panels with glue and screws.

- Center spacer panel on the backer panel, left to right and top to bottom. Secure the panels with glue.
- Center the spacer/backer panel on the overlay panel. Secure with glue and screws. Countersink screws into the backer panel.

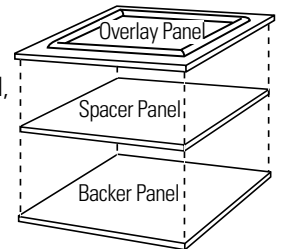

Listed by
Underwriters
Laboratories

For answers to your Monogram® GE Profile™ or GE® appliance questions, visit our website at GEAppliances.com or call GE Answer Center® service, 800.626.2000.



Monogram®

**ZIFI240PII – GE Monogram Fresh-Food Refrigerator Module
(Custom panel required)**

**ZIFS240PSS – GE Monogram Fresh-Food Refrigerator Module
(Stainless steel)**

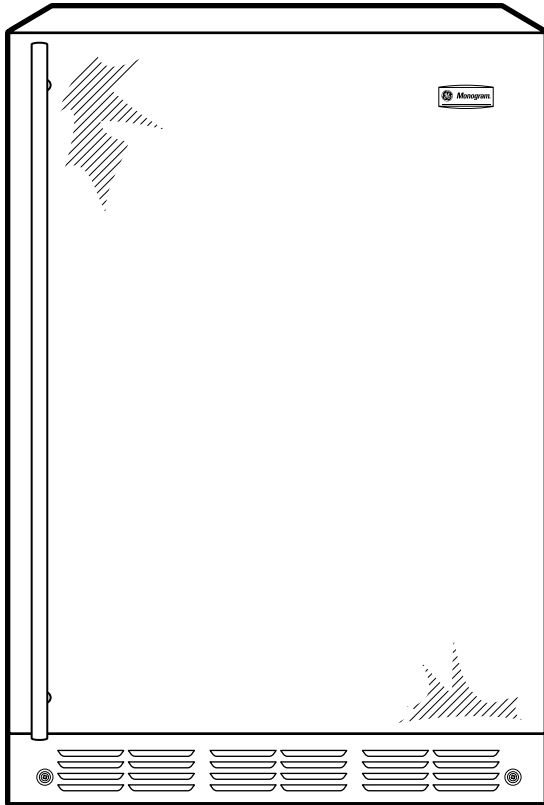

Features and Benefits

- Electronic adjustable temperature control – Offers a range of temperatures for precise chilling
- LED temperature display – Allows you to monitor the temperature at a glance
- Clear LEXAN® crisper on full-extension slides – Provides easy access to contents
- Removable spillproof glass shelves – Helps contain spills for ease of cleaning
- QuickSpace™ Shelf – Quickly slides out of the way to make room for tall items
- Custom panel and handle required – Customer must install a custom door panel and handle to complement their décor (ZIFI240PII only)
- Model ZIFS240PSS – Stainless steel
- Model ZIFI240PII – Custom panel and handle required



Specification Created 3/04

120032