



Self-Cleaning Gas Ranges

Safety Instructions ...2-7

Operating Instructions

Aluminum Foil13
 Clock and Timer15, 16
 Gas/Control Lockout25
 Lower Oven Drawer29
 Oven11-31
 Baking and Roasting13
 Broiling, Broiling Guide14
 Convection19-23
 Oven Control11
 Power Outage12
 Preheating13
 Probe18
 Racks12
 Sabbath Feature26, 27
 Self-Cleaning30, 31
 Special Features24, 25
 Thermostat28, 29
 Timed Baking and Roasting17
 Timed Convection Baking23
 Surface Cooking8-10
 Griddle10

Care and Cleaning

Burner Assembly32, 33
 Burner Grates34
 Control Panel and Knobs35
 Cooktop35
 Door Removal37
 Drawer38
 Griddle34
 Oven Bottom37
 Oven Light Replacement38
 Oven Vents35
 Racks37
 Self-Cleaning30, 31
 Stainless Steel Surfaces36

Installation

Instructions39-50
 Air Adjustment49
 Anti-Tip Device42, 50
 Assemble Surface Burners47
 Checking Burner Ignition48
 Connecting the Range to Gas43-45
 Dimensions and Clearances ...41
 Electrical Connections46, 47
 Leveling the Range49
 LP50

Troubleshooting

Tips51-54

Accessories57

Consumer Support

Consumer Support ...Back Cover
 Ownership Registration for Customers in Canada only55, 56
 Warranty for Customers in Canada59
 Warranty for Customers in the U.S.A.58

Owner's Manual & Installation Instructions

CGS980

Write the model and serial numbers here:

Model # _____

Serial # _____

You can find them on a label on the front of the range behind the lower oven drawer.

IMPORTANT SAFETY INFORMATION. READ ALL INSTRUCTIONS BEFORE USING.

⚠ WARNING!

For your safety, the information in this manual must be followed to minimize the risk of fire or explosion, electric shock, or to prevent property damage, personal injury, or loss of life.



⚠ WARNING: If the information in this manual is not followed exactly, a fire or explosion may result causing property damage, personal injury or death.

- Do not store or use gasoline or other flammable vapors and liquids in the vicinity of this or any other appliance.
- **WHAT TO DO IF YOU SMELL GAS**
 - Do not try to light any appliance.
 - Do not touch any electrical switch; do not use any phone in your building.
 - Immediately call your gas supplier from a neighbor's phone. Follow the gas supplier's instructions.
 - If you cannot reach your gas supplier, call the fire department.
- Installation and service must be performed by a qualified installer, service agency or the gas supplier.



ANTI-TIP DEVICE



⚠ WARNING

- All ranges can tip.
- BURNS or other SERIOUS INJURIES can result.
- INSTALL and CHECK the ANTI-TIP bracket following the instructions supplied with the bracket.



To reduce the risk of tipping the range, the range must be secured by a properly installed anti-tip bracket. See installation instructions shipped with the bracket for complete details before attempting to install.

To check if the bracket is installed and engaged properly, carefully tip the range forward. The bracket should stop the range within 4 inches. If it does not, the bracket must be reinstalled. If the range is pulled from the wall for any reason, always repeat this procedure to verify the range is properly secured by the anti-tip bracket.

For free-standing or slide-in ranges, never completely remove the leveling legs or the range will not be secured to the anti-tip device properly.

If you did not receive an anti-tip bracket with your purchase, call 1.800.626.8774 to receive one at no cost (in Canada, call 1.800.561.3344). For installation instructions of the bracket, visit GEAppliances.com (in Canada, GEAppliances.ca).

⚠ WARNING!



IMPORTANT SAFETY NOTICE

The California Safe Drinking Water and Toxic Enforcement Act requires the Governor of California to publish a list of substances known to the state to cause birth defects or other reproductive harm, and requires businesses to warn customers of potential exposure to such substances.

Gas appliances can cause minor exposure to four of these substances, namely benzene, carbon monoxide, formaldehyde and soot, caused primarily by the incomplete combustion of natural gas or LP fuels. Properly adjusted burners, indicated by a bluish rather than a yellow flame, will minimize incomplete combustion. Exposure to these substances can be minimized by venting with an open window or using a ventilation fan or hood.



SAFETY PRECAUTIONS

Have the installer show you the location of the range gas shut-off valve and how to shut it off if necessary.

- Have your range installed and properly grounded by a qualified installer, in accordance with the Installation Instructions. Any adjustment and service should be performed only by qualified gas range installers or service technicians.
- Do not attempt to repair or replace any part of your range unless it is specifically recommended in this manual. All other service should be referred to a qualified technician.
- Plug your range into a 120-volt grounded outlet only. Do not remove the round grounding prong from the plug. If in doubt about the grounding of the home electrical system, it is your personal responsibility and obligation to have an ungrounded outlet replaced with a properly grounded, three-prong outlet in accordance with the National Electrical Code. Do not use an extension cord with this appliance.

IMPORTANT SAFETY INFORMATION. READ ALL INSTRUCTIONS BEFORE USING.

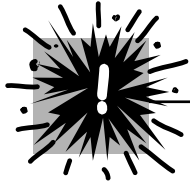

SAFETY PRECAUTIONS

- Locate the range out of kitchen traffic path and out of drafty locations to prevent poor air circulation.
- Be sure all packaging materials are removed from the range before operating it to prevent fire or smoke damage should the packaging material ignite.
- Be sure your range is correctly adjusted by a qualified service technician or installer for the type of gas (natural or LP) that is to be used. Your range can be converted for use with either type of gas. See the *Installation of the range* section.

⚠ WARNING: These adjustments must be made by a qualified service technician in accordance with the manufacturer's instructions and all codes and requirements of the authority having jurisdiction. Failure to follow these instructions could result in serious injury or property damage. The qualified agency performing this work assumes responsibility for the conversion.

- After prolonged use of a range, high floor temperatures may result and many floor coverings will not withstand this kind of use. Never install the range over vinyl tile or linoleum that cannot withstand such type of use. Never install it directly over interior kitchen carpeting.
- Do not leave children alone or unattended where a range is hot or in operation. They could be seriously burned.
- Do not allow anyone to climb, stand or hang on the oven door, lower oven drawer or cooktop. They could damage the range and even tip it over, causing severe personal injury.
- **⚠ CAUTION:** Items of interest to children should not be stored in cabinets above a range or on the backsplash of a range—children climbing on the range to reach items could be seriously injured.

⚠ WARNING: NEVER use this appliance as a space heater to heat or warm the room. Doing so may result in carbon monoxide poisoning and overheating of the oven.

- Never wear loose fitting or hanging garments while using the appliance. Be careful when reaching for items stored in cabinets over the range. Flammable material could be ignited if brought in contact with flame or hot oven surfaces and may cause severe burns.
 - Do not store flammable materials in an oven, a range drawer or near a cooktop.
 - Do not store or use combustible materials, gasoline or other flammable vapors and liquids in the vicinity of this or any other appliance.
 - Do not let cooking grease or other flammable materials accumulate in or near the range.
 - Do not use water on grease fires. Never pick up a flaming pan. Turn the controls off. Smother a flaming pan on a surface burner by covering the pan completely with a well-fitting lid, cookie sheet or flat tray. Use a multi-purpose dry chemical or foam-type fire extinguisher.
- Flaming grease outside a pan can be put out by covering it with baking soda or, if available, by using a multi-purpose dry chemical or foam-type fire extinguisher.
- Flame in the upper oven or lower oven drawer can be smothered completely by closing the oven door or drawer and turning the control to off or by using a multi-purpose dry chemical or foam-type fire extinguisher.
- Let the burner grates and other surfaces cool before touching them or leaving them where children can reach them.
 - Never block the vents (air openings) of the range. They provide the air inlet and outlet that are necessary for the range to operate properly with correct combustion. Air openings are located at the rear of the cooktop, at the top and bottom of the oven door, and at the bottom of the range under the lower oven drawer.
 - Large scratches or impacts to glass doors can lead to broken or shattered glass.

⚠️ WARNING!



SURFACE BURNERS

Use proper pan size—avoid pans that are unstable or easily tipped. Select cookware having flat bottoms large enough to cover burner grates. To avoid spillovers, make sure cookware is large enough to contain the food properly. This will both save cleaning time and prevent hazardous accumulations of food, since heavy spattering or spillovers left on range can ignite. Use pans with handles that can be easily grasped and remain cool.

- Always use the **LITE** position when igniting the top burners and make sure the burners have ignited.
- Never leave the surface burners unattended at high flame settings. Boilovers cause smoking and greasy spillovers that may catch on fire.
- Adjust the top burner flame size so it does not extend beyond the edge of the cookware. Excessive flame is hazardous.
- Use only dry pot holders— moist or damp pot holders on hot surfaces may result in burns from steam. Do not let pot holders come near open flames when lifting cookware. Do not use a towel or other bulky cloth in place of a pot holder.
- When using glass cookware, make sure it is designed for top-of-range cooking.
- To minimize the possibility of burns, ignition of flammable materials and spillage, turn cookware handles toward the side or back of the range without extending over adjacent burners.
- Carefully watch foods being fried at a high flame setting.
- Always heat fat slowly, and watch as it heats.
- Do not leave any items on the cooktop. The hot air from the vent may ignite flammable items and will increase pressure in closed containers, which may cause them to burst.
- If a combination of oils or fats will be used in frying, stir together before heating or as fats melt slowly.
- Use a deep fat thermometer whenever possible to prevent overheating fat beyond the smoking point.
- Use the least possible amount of fat for effective shallow or deep-fat frying. Filling the pan too full of fat can cause spillovers when food is added.
- Do not flame foods on the cooktop. If you do flame foods under the hood, turn the fan on.
- Do not use a wok on the cooking surface if the wok has a round metal ring that is placed over the burner grate to support the wok. This ring acts as a heat trap, which may damage the burner grate and burner head. Also, it may cause the burner to work improperly. This may cause a carbon monoxide level above that allowed by current standards, resulting in a health hazard.
- Foods for frying should be as dry as possible. Frost on frozen foods or moisture on fresh foods can cause hot fat to bubble up and over the sides of the pan.
- Never try to move a pan of hot fat, especially a deep fat fryer. Wait until the fat is cool.
- Do not leave plastic items on the cooktop—they may melt if left too close to the vent.
- Keep all plastics away from the surface burners.
- To avoid the possibility of a burn, always be certain that the controls for all burners are at the **OFF** position and all grates are cool before attempting to remove them.
- If range is located near a window, do not hang long curtains that could blow over the surface burners and create a fire hazard.
- If you smell gas, turn off the gas to the range and call a qualified service technician. Never use an open flame to locate a leak.
- Always turn the surface burner controls off before removing cookware.
- Do not lift the cooktop. Lifting the cooktop can lead to damage and improper operation of the range.
- When disabling Gas/Control Lockout, make sure the surface controls are set to the **OFF** position. This will preclude gas flow when the range is turned on

IMPORTANT SAFETY INFORMATION. READ ALL INSTRUCTIONS BEFORE USING.



LOWER OVEN DRAWER

- The purpose of the warm setting of the lower oven drawer is to hold hot cooked foods at serving temperature. Always start with hot food; cold food cannot be heated or cooked using the warm setting of the lower oven drawer.
- Do not use the drawer to dry newspapers. If overheated, they can catch on fire.
- Do not leave paper products, plastics, canned food or combustible materials in the drawer.
- Never leave jars or cans of fat drippings in or near your drawer.
- Do not warm food in the drawer for more than two hours.
- Never place, use or self-clean the lower oven drawer pan in the upper oven.
- **Do not touch the heating element or the interior surface of the drawer.** These surfaces may be hot enough to burn.
- **REMEMBER:** The inside surface of the drawer may be hot when the drawer is opened.
- Use care when opening the drawer. Open the drawer a crack and let hot air or steam escape before removing or replacing food. Hot air or steam which escapes can cause burns to hands, face and/or eyes.
- Do not use aluminum foil to line the lower oven drawer. Foil is an excellent heat insulator and will trap heat beneath it. This will upset the performance of the drawer and it could damage the interior finish.



COOK MEAT AND POULTRY THOROUGHLY...

Cook meat and poultry thoroughly—meat to at least an INTERNAL temperature of 160°F and poultry to at least an INTERNAL temperature of 180°F. Cooking to these temperatures usually protects against foodborne illness.



SELF-CLEANING THE UPPER OVEN

- Be sure to wipe off excess spillage before self-cleaning operation.
- Before self-cleaning the oven, remove any broiler pan, broiler grid, all cookware, probe and any aluminum foil.
- Never place, use or self-clean the lower oven drawer pan in the upper oven.
- The gray porcelain-coated oven racks may be cleaned in the oven during the self-clean cycle.
- Clean only parts listed in this Owner's Manual.
- Do not clean the door gasket. The door gasket is essential for a good seal. Care should be taken not to rub, damage or move the gasket.
- If the self-cleaning mode malfunctions, turn the oven off and disconnect the power supply. Have it serviced by a qualified technician.
- Do not use oven cleaners. No commercial oven cleaner or oven liner of any kind should be used in or around any part of the oven. Residue from oven cleaners will damage the inside of the oven when the self-clean cycle is used.



UPPER OVEN

Stand away from the range when opening the door of a hot oven. The hot air and steam that escape can cause burns to hands, face and eyes.

- Do not use the oven for a storage area. Items stored in the oven can ignite.
 - Keep the oven free from grease buildup.
 - Place the oven racks in the desired position while the oven is cool.
 - Pulling out the rack to the stop-lock is a convenience in lifting heavy foods. It is also a precaution against burns from touching hot surfaces of the door or oven walls. The lowest position is not designed to slide.
 - Do not heat unopened food containers. Pressure could build up and the container could burst, causing an injury.
- ▲ WARNING:** NEVER cover any slots, holes or passages in the oven bottom or cover an entire rack with materials such as aluminum foil. Doing so blocks air flow through the oven and may cause carbon monoxide poisoning. Aluminum foil linings may also trap heat, causing a fire hazard.
- Do not use aluminum foil anywhere in the oven except as described in this manual. Misuse could result in a fire hazard or damage to the range.
 - When using cooking or roasting bags in the oven, follow the manufacturer's directions.
 - Do not use your oven to dry newspapers. If overheated, they can catch fire.
 - Use only glass cookware that is recommended for use in gas ovens.
 - Always remove any broiler pan from range as soon as you finish broiling. Grease left in the pan can catch fire if oven is used without removing the grease from the broiler pan.
 - When broiling, if meat is too close to the flame, the fat may ignite. Trim excess fat to prevent excessive flare-ups.
 - Make sure any broiler pan is in place correctly to reduce the possibility of grease fires.
 - If you should have a grease fire in a broiler pan, press the **CLEAR/OFF** pad, and keep the oven door closed to contain fire until it burns out.
 - For safety and proper cooking performance, always bake and broil with the oven door closed.
 - Never place, use or self-clean the lower oven drawer pan in the upper oven.



**READ AND FOLLOW THIS SAFETY INFORMATION CAREFULLY.
SAVE THESE INSTRUCTIONS**

Using the gas surface burners.

Throughout this manual, features and appearance may vary from your model.

Before Lighting a Gas Burner

- Make sure all burners are in place.
- Make sure all grates on the range are properly placed before using any burner.
- If your range has the Gas/Control Lockout feature, make sure it is disabled before attempting to light the surface burners.

After Lighting a Gas Burner

- Do not operate the burner for an extended period of time without cookware on the grate. The finish on the grate may chip without cookware to absorb the heat.
- Be sure the burners and grates are cool before you place your hand, a pot holder, cleaning cloths or other materials on them.

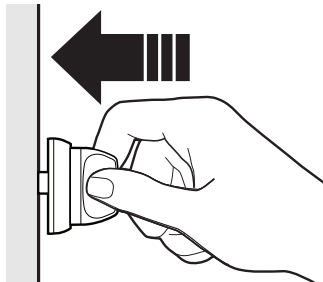

Push the control knob in and turn it to the **LITE** position.

How to Light a Gas Surface Burner

Make sure all the surface burners are placed in their respective positions.

Push the control knob in and turn it to the **LITE** position.

You will hear a little **clicking** noise—the sound of the electric spark igniting the burner.

Turn the knob to adjust the flame size. If the knob stays at **LITE**, it will continue to click.

When one burner is turned to **LITE**, all the burners spark. Do not attempt to disassemble or clean around any burner while another burner is on. An electric shock may result, which could cause you to knock over hot cookware.

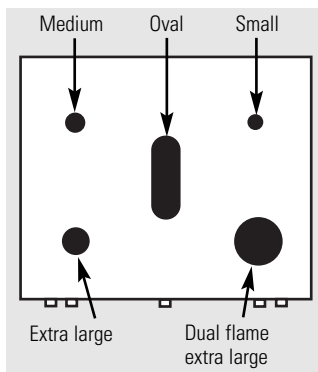

Sealed Gas Burners

Your gas range cooktop has five sealed gas burners. They offer convenience, cleanability and flexibility to be used in a wide range of cooking applications.

The smallest burner in the right rear position is the simmer burner. This burner can be turned down to **LO** for a very low simmer setting. It provides precise cooking performance for delicate foods such as sauces or foods that require low heat for a long cooking time.

The medium (left rear) and the extra large (left front) burners are the primary burners for most cooking. These general-purpose burners can be turned down from **HI** to **LO** to suit a wide range of cooking needs. The extra large (left front) burner also has a special **POWER BOIL™** setting designed to be used with cookware 10 inches or larger in diameter.

The dual flame extra large burner (right front) is the maximum output burner. Like the other four burners, it can be turned down from **HI** to **LO** for a wide range of cooking applications; however, this burner is designed to quickly bring large amounts of liquid to a boil. It has a special **POWER BOIL™** setting designed to be used with cookware 10 inches or larger in diameter.

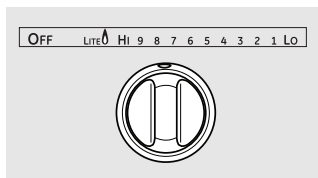

Small, medium and center burner graphics only.

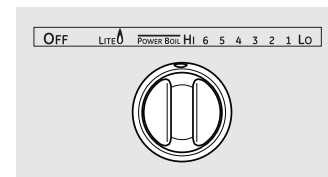

Extra large and dual flame extra large burners only.

The center oval burner is the largest in size and is for large oval pots/pans, round pots/pans 10" or greater in diameter or with the griddle.

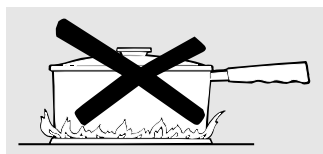

How to Select Flame Size

For safe handling of cookware, never let the flames extend up the sides of the cookware.

Watch the flame, not the knob, as you reduce heat. When fast heating is desired, the flame size on a gas burner should match the cookware you are using.

Flames larger than the bottom of the cookware will not result in faster heating of the cookware and could be hazardous.

Top-of-Range Cookware

Aluminum: Medium-weight cookware is recommended because it heats quickly and evenly. Most foods brown evenly in an aluminum skillet. Use saucepans with tight-fitting lids when cooking with minimum amounts of water.

Cast-Iron: If heated slowly, most skillets will give satisfactory results.

Enamelware: Under some conditions, the enamel of some cookware may melt. Follow cookware manufacturer's recommendations for cooking methods.

Glass: There are two types of glass cookware—those for oven use only and those for top-of-range cooking (saucepans, coffee and teapots). Glass conducts heat very slowly.

Heatproof Glass Ceramic: Can be used for either surface or oven cooking. It conducts heat very slowly and cools very slowly. Check cookware manufacturer's directions to be sure it can be used on gas ranges.

Stainless Steel: This metal alone has poor heating properties and is usually combined with copper, aluminum or other metals for improved heat distribution. Combination metal skillets usually work satisfactorily if they are used with medium heat as the manufacturer recommends.



Stove Top Grills

Do not use stove top grills on your sealed gas burners. If you use the stove top grill on the sealed gas burner, it will cause incomplete combustion and can result in exposure to carbon monoxide levels above allowable current standards.

This can be hazardous to your health.

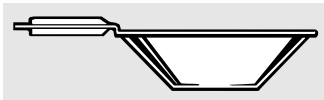

Use a flat-bottomed wok.

Wok This Way

We recommend that you use a 14-inch or smaller flat-bottomed wok. Make sure the wok bottom sits flat on the grate. They are available at your local retail store.

Only a flat-bottomed wok should be used.

Do not use a wok support ring. Placing the ring over the burner or grate may cause the burner to work improperly, resulting in carbon monoxide levels above allowable standards. This could be dangerous to your health.

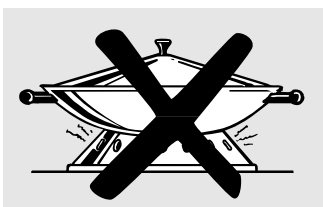

In Case of Power Failure

In case of a power failure, you can light the gas surface burners on your range with a match. Hold a lit match to the burner, then push in and turn the control knob to the **LITE** position. Use extreme caution when lighting burners this way.

Surface burners in use when an electrical power failure occurs will continue to operate normally.

NOTE: If Gas/Control Lockout is in use at the time of a power failure, the surface burners cannot be lit.

Using the griddle.

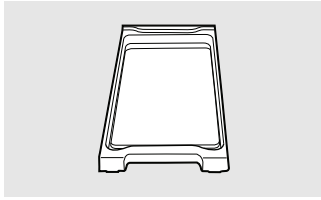

Your non-stick coated griddle provides an extra-large cooking surface for meats, pancakes, or other food usually prepared in a frying pan or skillet.

NOTE: Your griddle will discolor over time as it becomes seasoned with use.

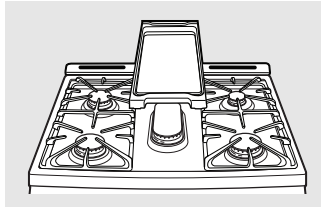

How to Insert the Griddle

CAUTION: Place and remove the griddle only when all grates and griddle are cool and all surface units are turned OFF.

NOTE: Do not clean the griddle in the self-cleaning oven.

The griddle can only be used with the center burner. To insert the griddle, remove the center grate and replace with the griddle.

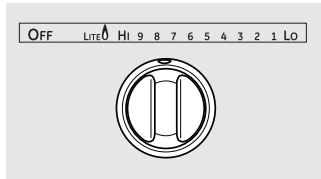

Using the Griddle

Most griddled foods require cooking on a preheated surface. Preheat griddle according to the guide below, then switch to the desired cook setting.

Type of Food	Preheat Conditions	Cook Setting
Warming Tortillas	none	3 (MED-LOW)
Pancakes	4 (MED) 10 min.	4 (MED)
Hamburgers	HI 5 min.	5 (MED) Sear on HI for 1 minute on each side
Fried Eggs	HI 5 min.	4 (MED)
Bacon	none	5 (MED)
Breakfast Sausage Links	HI 5 min.	5 (MED)
Hot Sandwiches (such as Grilled Cheese)	HI 4 min.	HI

NOTE: Griddle settings may need to be adjusted if the griddle is used for an extended time.

IMPORTANT NOTES:

- Avoid cooking extremely greasy foods and be careful of grease spill-over while cooking.
- Do not use oil on the griddle for extended lengths of time. Permanent staining and/or craze lines on the surface could result.
- Never place or store any items on the griddle, even when it is not in use. The griddle can become heated when using the surrounding burners.
- **Do not overheat the griddle.** Leaving the griddle burner on at HI for an extended amount of time without food can damage the non-stick coating.
- Avoid using metal utensils with sharp points or rough sharp edges which might damage the griddle surface.
- Do not cut foods on the griddle.

Using the upper oven controls.

(Throughout this manual, features and appearance may vary from your model.)

GEAppliances.com

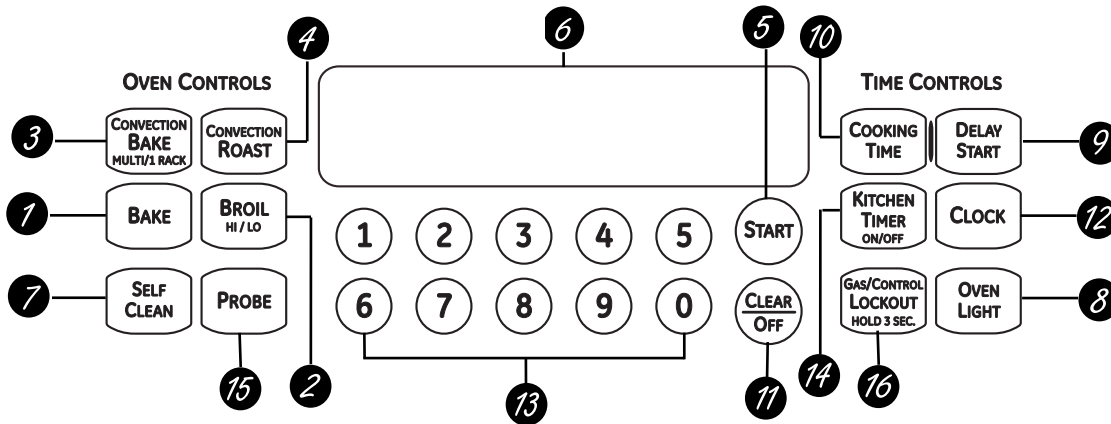

Features and appearance may vary.



Oven Control, Clock, Timer and Features

- 1** **BAKE Pad**
Touch to select the bake function.
- 2** **BROIL HI/LO Pad**
Touch to select the broil function.
- 3** **CONVECTION BAKE MULTI/1 RACK Pad**
Touch to select baking with the convection function.
- 4** **CONVECTION ROAST Pad**
Touch to select roasting with the convection function.
- 5** **START Pad**
Must be touched to start any cooking or cleaning function.
- 6** **Display**
Shows the time of day, oven temperature, whether the oven is in the bake, broil or self-cleaning mode, the times set for the timer or automatic oven operations, and if the range is locked.
- 7** **SELF-CLEAN Pad**
Touch to select self-cleaning function. See the *Using the self-cleaning oven* section.
- 8** **OVEN LIGHT Pad**
Touch to turn the oven light on or off.
- 9** **DELAY START Pad**
Use along with **COOKING TIME** or **SELF CLEAN** pads to set the oven to start and stop automatically at a time you set.
- 10** **COOKING TIME Pad**
Touch and then touch the number pads to set the amount of time you want your food to cook. The oven will shut off when the cooking time has run out.
- 11** **CLEAR/OFF Pad**
Touch to cancel **ALL** upper oven operations except the clock, timer and Gas/Control Lockout.
- 12** **CLOCK Pad**
Touch before setting the clock.
- 13** **Number Pads**
Use to set any function requiring numbers such as the time of day on the clock, the timer, the oven temperature, the internal food temperature, the start time and length of operation for timed baking and self-cleaning.
- 14** **KITCHEN TIMER ON/OFF Pad**
Touch to select the timer feature.
- 15** **PROBE Pad**
Touch when using the probe to cook food.
- 16** **GAS/CONTROL LOCKOUT Pad**
Touch and hold the **GAS/CONTROL LOCKOUT** pad for 3 seconds to lock/unlock the surface burners, oven burners and control panel so they cannot be activated.

If "F- and a number or letter" flash in the display and the oven control signals, this indicates a function error code. Touch the CLEAR/OFF pad. Allow the oven to cool for one hour. Put the oven back into operation. If the function error code repeats, disconnect the power to the oven and call for service.

If your oven was set for a timed oven operation and a power outage occurred, the clock and all programmed functions must be reset.

The time of day will flash in the display when there has been a power outage.

Safety Instructions

Operating Instructions

Installation Instructions

Troubleshooting Tips

Consumer Support

Using the upper oven.

To avoid possible burns, place the racks in the desired position before you turn the oven on.

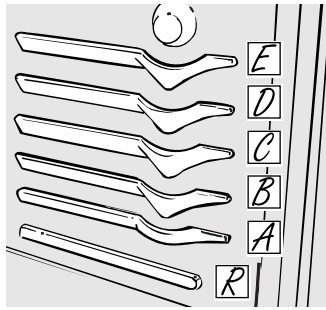

The oven has 5 rack positions.

It also has a special low rack position (R) for extra large items, such as a large turkey.

Before you begin...

The racks have stop-locks, so that when placed correctly on the rack supports (A through E), they will stop before coming completely out, and will not tilt.

When placing and removing cookware, pull the rack out to the bump on the rack support.

To remove a rack, pull it toward you, tilt the front end up and pull it out.

To replace, place the end of the rack (stop-locks) on the support, tilt up the front and push the rack in.

NOTE: The rack is not designed to slide out at the special low rack (R) position.

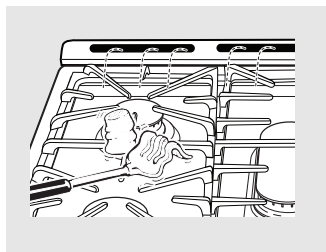

Plastic items on the cooktop may melt if left too close to the vent.

Vent appearance and location vary.

Upper Oven Vent

Your oven is vented through ducts at the rear of the range. Do not block these ducts when cooking in the oven—it is important that the flow of hot air from the oven and fresh air to the oven burner be uninterrupted. Avoid touching the vent openings or nearby surfaces during oven or broiler operation—they may become hot.

- Handles of pots and pans on the cooktop may become hot if left too close to the vent.
- Do not leave plastic or flammable items on the cooktop—they may melt or ignite if left too close to the vent.
- Do not leave closed containers on the cooktop. The pressure in closed containers may increase, which may cause them to burst.
- Metal items will become very hot if they are left on the cooktop, and could cause burns.

Power Outage

CAUTION: Do not make any attempt to operate the electric ignition oven during an electrical power failure.

The oven or broiler cannot be lit during a power failure. Gas will not flow unless the glow bar is hot.

If the oven is in use when a power failure occurs, the oven burner shuts off and cannot be re-lit until power is restored. This is because the flow of gas is automatically stopped and will not resume when power is restored until the glow bar has reached operating temperature.

Upper Oven Light

Touch the **OVEN LIGHT** pad to turn the light on or off.



The oven has a special low rack (R) position just above the oven bottom. Use it when extra cooking space is needed, for example, when cooking a large turkey. The rack is not designed to slide out at this position.

How to Set the Upper Oven for Baking or Roasting

Your oven is not designed for open-door cooking.

- 1 Touch the **BAKE** pad.
- 2 Touch the number pads to set the desired temperature.
- 3 Touch the **START** pad.

The word **ON** and **100°** will be displayed. As the oven heats up, the display will show the changing temperature. When the oven reaches the temperature you set, a tone will sound.

To change the oven temperature during BAKE cycle, press the **BAKE** pad and then the number pads to get the new temperature.

- 4 Check food for doneness at minimum time on recipe. Cook longer if necessary.
- 5 Touch the **CLEAR/OFF** pad when cooking is complete.

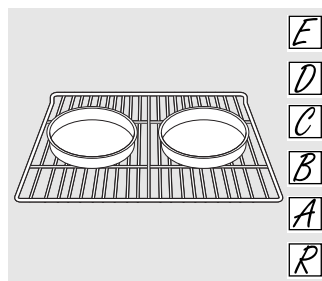

When baking on a single rack, use the rack position from the chart for your type of food. Baking results will be better if baking pans are centered in the oven as much as possible.

Preheating and Pan Placement

Preheat the oven if the recipe calls for it. To preheat, set the oven at the correct temperature. Preheating is necessary when convection baking and for good results when baking cakes, cookies, pastry and breads.

Baking results will be better if foods are centered in the oven as much as possible. Pans should not touch each other or the walls of the oven.

For best results when baking four cake layers at a time, use racks B and D. Place the lower pans at the back of the rack and the upper pans at the front of the rack as shown so that one pan is not directly above another leaving approximately 1-1/2" between pans, from the front, back and sides of the walls.

Type of Food	Rack Position
Pies – On cookie sheet	C
Angel food cake	A
Bundt or pound cakes	B
Biscuits, muffins, brownies, cookies, cupcakes, layer cakes, pies	C
Casseroles	C
Roasting – Small cuts of meat	A or B
Roasting – Turkey and large cuts of meat	R or A
4-Layer cakes	B & D

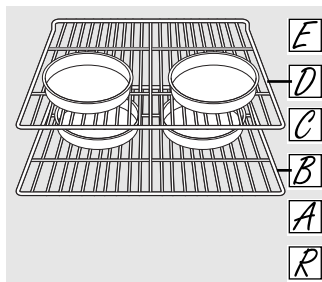

When baking four cake layers at a time, use racks B and D. Place the lower pans at the back of the rack and the upper pans to the front of the rack shown so that one pan is not directly above another.

Aluminum Foil

Do not use aluminum foil on the bottom of the oven.

Never entirely cover a rack with aluminum foil. This will disturb the heat circulation and result in poor baking.

A smaller sheet of foil may be used to catch a spillover by placing it on a lower rack several inches below the food.

Oven Moisture

As your oven heats up, the temperature change of the air in the oven may cause water droplets to form on the door glass. These droplets are harmless and will evaporate as the oven continues to heat up.

Using the upper oven.

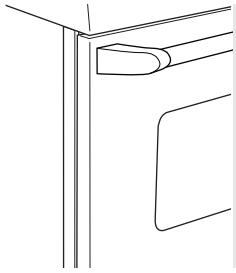

Close the door. **Always broil with the door closed.**

How to Set the Upper Oven for Broiling

- 1 Place the meat or fish on a broiler grid in a broiler pan.
- 2 Follow suggested rack positions in the *Broiling Guide*.
- 3 The oven door **must** be closed during broiling.
- 4 Touch the **BROIL HI/LO** pad once for **HI Broil**.

To change to **LO Broil**, touch the **BROIL HI/LO** pad again.

- 5 Touch the **START** pad.

NOTE: The display will always automatically remind you to close the door.

- 6 When broiling is finished, touch the **CLEAR/OFF** pad.

Serve the food immediately, and leave the pan outside the oven to cool during the meal for easiest cleaning.

Use **LO Broil** to cook foods such as poultry or thick cuts of meat thoroughly without over-browning them.

The size, weight, thickness, starting temperature and your preference of doneness will affect broiling times. This guide is based on meats at refrigerator temperature.

†The U.S. Department of Agriculture says "Rare beef is popular, but you should know that cooking it to only 140°F. means some food poisoning organisms may survive." (Source: *Safe Food Book, Your Kitchen Guide*, USDA Rev. June 1985.)

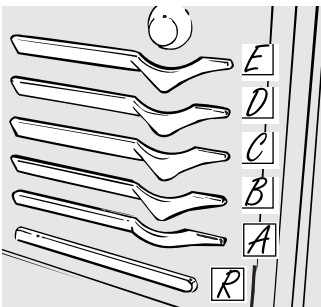

The oven has 5 rack positions.

Broiling Guide

Food	Quantity and/or Thickness	Rack* Position	First Side Time (min.)	Second Side Time (min.)	Comments
Bacon	1/2 lb. (about 8 thin slices)	C	4	3	Arrange in single layer.
Ground Beef Well Done	1 lb. (4 patties) 1/2 to 3/4" thick	C	10	7-10	Space evenly. Up to 8 patties take about the same time.
Beef Steaks					
Rare†	1" thick	C	9	7	Steaks less than 1" thick cook through before browning. Pan frying is recommended. Slash fat.
Medium	1 to 1½ lbs.	C	12	5-6	
Well Done		C	13	8-9	
Rare†	1½" thick	C	10	6-7	
Medium	2 to 2½ lbs.	C	12-15	10-12	
Well Done		C	25	16-18	
Chicken					
	1 whole 2 to 2½ lbs., split lengthwise 4 bone-in breasts	B	30-35	15-20	Brush each side with melted butter. Broil skin-side-down first.
		B	25-30	10-15	
Lobster Tails	2-4 6 to 8 oz. each	C	13-16	Do not turn over.	Cut through back of shell. Spread open. Brush with melted butter before broiling and after half of broiling time.
Fish Fillets	1/4 to 1/2" thick	D	6	6	Handle and turn very carefully. Brush with lemon butter before and during cooking, if desired. Preheat broiler to increase browning.
Ham Slices (precooked)					
	1" thick	C	8	8	
	1/2" thick	D	6	6	
Pork Chops Well Done	2 (1½" thick) 2 (1" thick) about 1 lb.	D D	10 15	8 8	Slash fat.
Lamb Chops Medium	2 (1" thick) about 10 to 12 oz.	D	8	4-7	Slash fat.
Well Done		D	10	10	
Medium	2 (1½" thick) about 1 lb.	D	10	4-6	
Well Done		D	17	12-14	

*See illustration for description of rack positions.

Using the clock and timer.

Not all features are on all models.



Make sure the clock is set to the correct time of day.

To Set the Clock

The clock must be set to the correct time of day for the automatic oven timing functions to work properly. The time of day cannot be changed during a timed baking or self-cleaning cycle.

- 1 Touch the **CLOCK** pad to set.
- 2 Touch the number pads.

Touch the number pads the same way you read them. For example, to set 12:34, touch the number pads **1, 2, 3** and **4** in that order.

If number pads are not touched within one minute after you touch the **CLOCK** pad, the display reverts to the original setting. If this happens, touch the **CLOCK** pad and reenter the time of day.

- 3 Touch the **START** pad until the time of day shows in the display. This enters the time and starts the clock.

*To check the time of day when the display is showing other information, simply touch the **CLOCK** pad. The time of day shows until another pad is touched.*

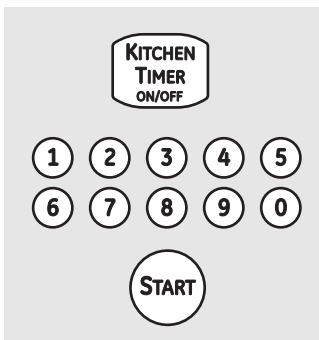

The timer is a minute timer only.
The **CLEAR/OFF** pad does not affect the timer.

To Set the Timer

The timer does not control oven operations. The maximum setting on the timer is 9 hours and 59 minutes.

- 1 Touch the **KITCHEN TIMER ON/OFF** pad.
- 2 Touch the number pads until the amount of time you want shows in the display. The maximum time that can be entered in minutes is 59. Times more than 59 minutes should be changed to hours and minutes. For example, to enter 90 minutes as 1 hour 30 minutes, touch **1, 3** and **0** in that order.

*If you make a mistake, press the **KITCHEN TIMER ON/OFF** pad and begin again.*

- 3 Touch the **START** pad. After pressing the **START** pad, **SET** disappears; this tells you the time is counting down, although the display does not change until one minute has passed.

- 4 When the timer reaches **:00**, the control will beep 3 times followed by one beep every 6 seconds until the **KITCHEN TIMER ON/OFF** pad is touched.

The 6 second tone can be canceled by following the steps in the Special features of your oven control section under Tones at the End of a Timed Cycle.

Using the clock and timer.

To Reset the Timer

If the display is still showing the time remaining, you may change it by touching the **KITCHEN TIMER ON/OFF** pad, then touch the number pads until the time you want appears in the display.

If the remaining time is not in the display (clock, delay start or cooking time are in the display), recall the remaining time by touching the **KITCHEN TIMER ON/OFF** pad and then touching the number pads to enter the new time you want.

To Cancel the Timer

Touch the **KITCHEN TIMER ON/OFF** pad twice.

Power Outage

If a flashing time is in the display, you have experienced a power failure. Reset the clock.

Touch the **CLOCK** pad to reset. Enter the correct time of day by touching the appropriate number pads. Touch the **START** pad.

Using the timed baking and roasting features. (upper oven only) GEAppliances.com

NOTE: Foods that spoil easily—such as milk, eggs, fish, stuffings, poultry and pork—should not be allowed to sit for more than 1 hour before or after cooking. Room temperature promotes the growth of harmful bacteria. Be sure that the oven light is off because heat from the bulb will speed harmful bacteria growth.

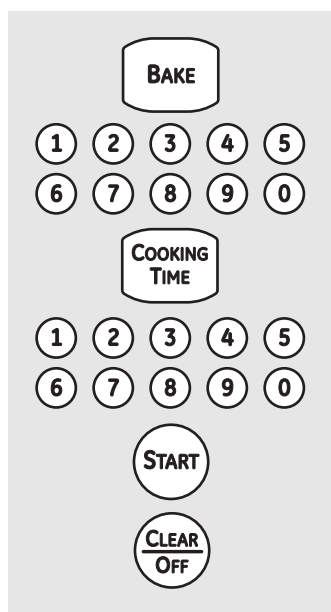

How to Set an Immediate Start and Automatic Stop

The upper oven will turn on immediately and cook for a selected length of time. At the end of the cooking time, the oven will turn off automatically.

- 1 Touch the **BAKE** pad.
- 2 Touch the number pads to set the desired oven temperature.
- 3 Touch the **COOKING TIME** pad.

NOTE: If your recipe requires preheating, you may need to add additional time to the length of the cooking time.

- 4 Touch the number pads to set the desired length of cooking time. The minimum cooking time you can set is 1 minute.

The oven temperature that you set and the cooking time that you entered will be in the display.

- 5 Touch the **START** pad.

The oven will turn **ON**, and the display will show the cooking time countdown and the changing temperature starting at 100°F. (The temperature display will start to change once the oven temperature reaches 100°F.) When the oven reaches the temperature you set, 3 beeps will sound.

The oven will continue to cook for the set amount of time, then turn off automatically.

After the oven turns off, the end-of-cycle tone will sound.

- 6 Touch the **CLEAR/OFF** pad to clear the display if necessary. Remove the food from the oven. Remember, even though the oven turns off automatically, food left in the oven will continue cooking after the oven turns off.

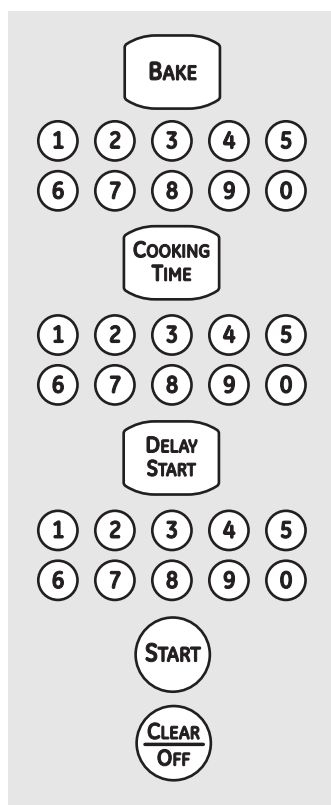

How to Set a Delayed Start and Automatic Stop

The upper oven will turn on at the time of day you set, cook for a specific length of time and then turn off automatically.

Make sure the clock shows the correct time of day.

- 1 Touch the **BAKE** pad.
- 2 Touch the number pads to set the desired oven temperature.
- 3 Touch the **COOKING TIME** pad.

NOTE: If your recipe requires preheating, you may need to add additional time to the length of the cooking time.

- 4 Touch the number pads to set the desired length of cooking time. The minimum cooking time you can set is 1 minute.

The oven temperature that you set and the cooking time that you entered will be in the display.

- 5 Touch the **DELAY START** pad.
- 6 Touch the number pads to set the time of day you want the oven to turn on and start cooking.
- 7 Touch the **START** pad.

NOTE: An attention tone will sound if you are using timed baking and do not touch the **START** pad.

NOTE: If you would like to check the times you have set, touch the **DELAY START** pad to check the start time you have set or touch the **COOKING TIME** pad to check the length of cooking time you have set.

When the oven turns **ON** at the time of day you set, the display will show the cooking time countdown and the changing temperature starting at 100°F. (The temperature display will start to change once the oven temperature reaches 100°F.) When the oven reaches the temperature you set, beeps will sound.

The oven will continue to cook for the set amount of time, then turn off automatically.

After the oven turns off, the end-of-cycle tone will sound.

- 8 Touch the **CLEAR/OFF** pad to clear the display if necessary. Remove the food from the oven. Remember, even though the oven turns off automatically, food left in the oven will continue cooking after the oven turns off.

Using the probe.

For many foods, especially roasts and poultry, internal food temperature is the best test for doneness. The temperature probe takes the guesswork out of cooking foods to the exact doneness you want.

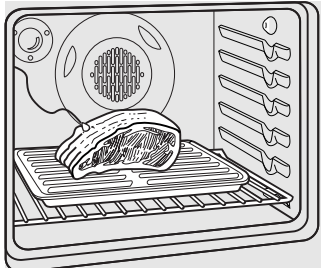

The temperature probe has a skewer-like probe at one end and a plug at the other end that goes into the outlet in the oven.

Use of probes other than the one provided with this product may result in damage to the probe.

Use the handles of the probe and plug when inserting and removing them from the food and outlet.

- To avoid damaging your probe, do not use tongs to pull on the cable when removing it.
- To avoid breaking the probe, make sure food is completely defrosted before inserting.
- To prevent possible burns, do not unplug the probe from the outlet until the oven has cooled.

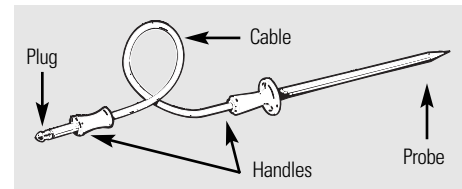

- Never leave your probe inside the oven during a self-cleaning cycle.
- Do not store the probe in the oven.

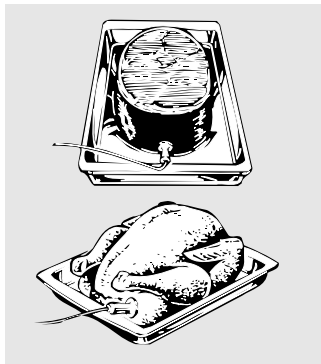

After preparing the meat and placing it on a trivet or on a broiler pan grid, follow these directions for proper probe placement.

Insert the probe completely into the meat. It should not touch the bone, fat or gristle.

For roasts with no bone, insert the probe into the meatiest part of the roast. For bone-in ham or lamb, insert the probe into the center of the lowest large muscle.

Insert the probe into the center of dishes such as meat loaf or casseroles.

Insert the probe into the meatiest part of the inner thigh from below and parallel to the leg of a whole turkey.

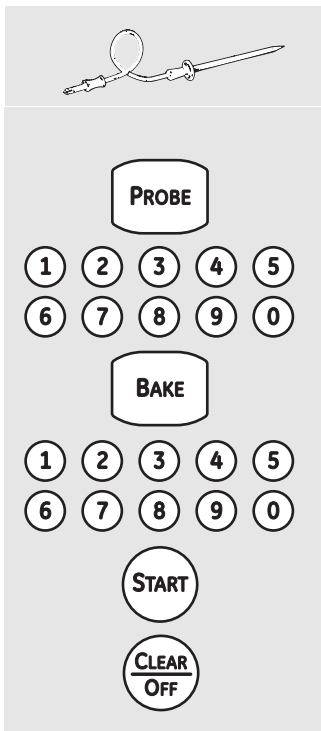

How to Set the Upper Oven For Cooking When Using the Probe

- 1 Insert the probe into the food.
- 2 Plug the probe into the outlet in the oven. Make sure it's pushed all the way in. Close the oven door.
- 3 Touch the **PROBE** pad.
- 4 Touch the number pads to set the desired internal food or meat temperature between 100°F and 200°F.
- 5 Touch the **BAKE** pad.
- 6 Touch the number pads to set the desired oven temperature.
- 7 Touch the **START** pad.

The display will flash if the probe is inserted into the outlet and you have not set a probe temperature and touched the **START** pad.

The display will show **LO** until the internal temperature of the food reaches 100°F; then the changing internal temperature will be shown.

- 8 When the internal temperature of the food reaches the number you have set, the probe and the oven turn off and the oven control signals. To stop the signal, touch the **CLEAR/OFF** pad. Use hot pads to remove the probe from the food. Do not use tongs to pull on it—they might damage it.

To change the oven temperature during probe cooking, touch the **BAKE** pad and then the number pads to set the new temperature.

- If the probe is removed from the food before the final temperature is reached, a tone will sound and the display will flash until the probe is removed from the oven.
- You can use the timer even though you cannot use timed oven operations while using the probe.

Using the convection oven.

The convection oven fan shuts off when the oven door is opened. DO NOT leave the door open for long periods of time while using convection cooking.

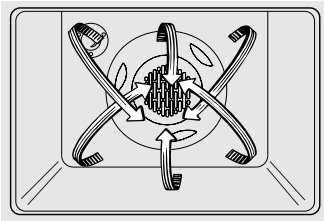

In a convection oven, a fan circulates hot air over, under and around the food. This circulating hot air is evenly distributed throughout the oven cavity. As a result, foods are evenly cooked and browned—often in less time than with regular heat.

NOTE: To maximize cooking evenness, the fan is designed to rotate in both directions with a pause in between. This is normal.

To help you understand the difference between convection bake and roast and traditional bake and roast, here are some general guidelines.

Convection Bake

- Preheat the oven. See the Using the Oven—Preheating and Pan Placement section.
- Ideal for foods cooked on multiple racks.
- Good for large quantities of baked foods.
- Good results with cookies, biscuits, brownies, cupcakes, cream puffs, sweet rolls, angel food cake and bread.

The convection fan circulates the heated air evenly over and around the food.

Convection Roast

- Good for large tender cuts of meat, uncovered.

The convection fan circulates the heated air evenly over and around the food. Meat and poultry are browned on all sides as if they were cooked on a rotisserie. Heated air will be circulated over, under and around the food being roasted. The heated air seals in juices quickly for a moist and tender product while, at the same time, creating a rich golden brown exterior.

Roasts or poultry should be cooked on rack position (A).

When you are convection roasting, it is important that you use a broiler pan and grid for best convection roasting results. The pan is used to catch grease spills and the grid is used to prevent grease spatters.

- Place the rack in rack position (A).

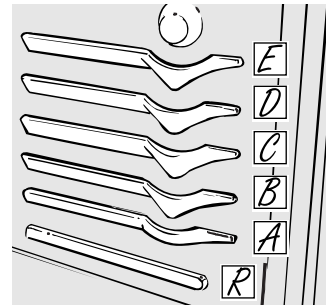

Using the convection oven.

Cookware for Convection Cooking

Before using your convection oven, check to see if your cookware leaves room for air circulation in the oven. If you are baking with several pans, leave space between them. Also, be sure the pans do not touch each other or the walls of the oven.

Paper and Plastic

Heat-resistant paper and plastic containers that are recommended for use in regular ovens can be used in convection ovens. Plastic cookware that is heat-resistant to temperatures of 400°F can also be used, when oven is below 400°F.

Metal and Glass

Any type of cookware will work in your convection oven. However, metal pans heat the fastest and are recommended for convection baking.

■ *Darkened or matte-finished pans will bake faster than shiny pans.*

■ *Glass or ceramic pans cook more slowly.*

When baking cookies, you will get the best results if you use a flat cookie sheet instead of a pan with low sides.

For recipes like oven-baked chicken, use a pan with low sides. Hot air cannot circulate well around food in a pan with high sides.

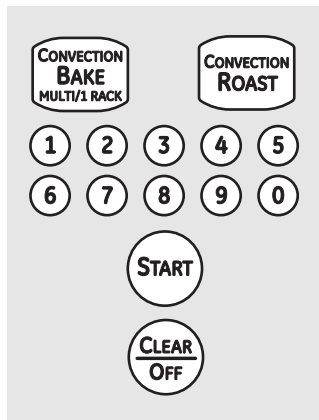

How to Set the Upper Oven for Convection Baking or Roasting

- 1 Touch the **CONVECTION BAKE MULTI/1 RACK** pad once for multi-rack convection baking. This mode is used for cooking food items on more than one rack (i.e., 2, 3 or more racks) at the same time in convection bake. See the *Multi-Rack Baking* section for more information. Touch the **CONVECTION BAKE MULTI/1 RACK** pad twice for one rack convection baking. This mode is used for cooking food items on only one rack in convection bake.

Touch the **CONVECTION ROAST** pad for convection roasting.

- 2 Touch the number pads to set the desired oven temperature.
- 3 Touch the **START** pad.

To change the oven temperature, touch the **CONVECTION BAKE MULTI/1 RACK** or **CONVECTION ROAST** pad and then the number pads to set the new temperature.

When the oven starts to heat, the changing temperature, starting at 100°F, will be displayed. When the oven reaches the temperature you set, 3 beeps will sound.

- 4 Touch the **CLEAR/OFF** pad when finished.

NOTE: You will hear a fan while cooking with convection. The fan will stop when the door is opened but the heat will not turn off.

The fan will not start until the preheat temperature is reached.

NOTE: When convection baking, the oven temperature will be 25°F (14°C) lower than the set temperature. See *Auto Recipe™ Conversion in the Special Features section for more information. When convection roasting, oven temperature will not auto convert.*

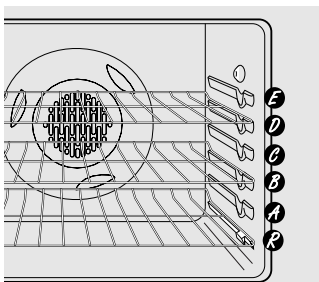

When convection baking with only 1 rack, follow the rack positions recommended in the Using the Oven section.

Multi-Rack Baking

The number of racks provided depends on your model.

Because heated air is circulated evenly throughout the oven, foods can be baked with excellent results using multiple racks.

Multi-rack baking may increase cook times slightly for some foods but the overall result is time saved. Cookies, muffins, biscuits and other quick breads give very good results with multi-rack baking.

To cook food on more than one rack in convection bake, use **CONVECTION BAKE MULTI**.

When baking larger foods on 3 racks, place one rack in the 2nd (A) position, one on the 4th (C) position and the third rack in the 6th (E) position.

When baking cookies, place the racks in the 3rd (B), 4th (C) and 6th (E) positions.

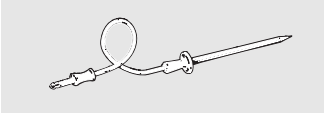

For best results when roasting large turkeys and roasts, we recommend using the probe included in the convection oven.

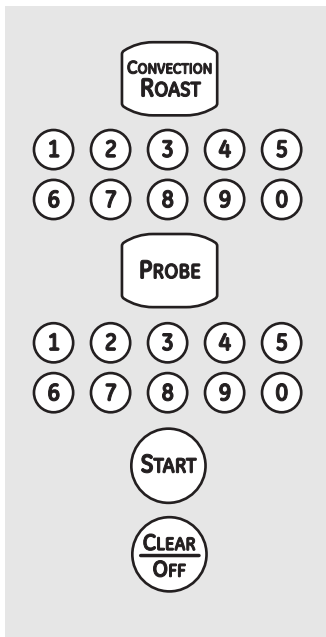

How to Set the Upper Oven for Convection Roasting when Using the Probe

The display will flash **PROBE** and the oven control will signal if the probe is inserted into the outlet, and you have not set a probe temperature and touched the **START** pad.

- 1 Place the rack in the rack position (A). Insert the probe completely into the food.
- 2 Plug the probe into the outlet in the oven. Make sure it is pushed all the way in. Close the oven door.
- 3 Touch the **CONVECTION ROAST** pad.
- 4 Touch the number pads to set the desired oven temperature.
- 5 Touch the **PROBE** pad.
- 6 Touch the number pads to set the desired internal food temperature.

To change the oven temperature during the Convection Roast cycle, touch the **CONVECTION ROAST** pad and then touch the number pads to set the new desired temperature.

- 7 Touch the **START** pad.

When the oven starts to heat, the word **LO** will be in the display.

After the internal temperature of the food reaches 100°F, the changing internal temperature will be shown in the display.

- 8 When the internal temperature of the food reaches the number you have set, the probe and the oven turn off and the oven control signals. To stop the signal, touch the **CLEAR/OFF** pad. Use hot pads to remove the probe from the food. Do not use tongs to pull on it—they might damage it.

CAUTION: To prevent possible burns, do not unplug the probe from the oven outlet until the oven has cooled. Do not store the probe in the oven.

NOTE:

- If the probe is removed from the food before the final temperature is reached, a tone will sound and the display will flash until the probe is removed from the oven.
- You will hear a fan while cooking with this feature. The fan will stop when the door is opened but the heat will not turn off.
- You can use the timer even though you cannot use timed oven operations while using the probe.

Using the convection oven.

Convection Roasting Guide

Meats		Minutes/Lb.	Oven Temp.	Internal Temp.	
Beef	Rib (3 to 5 lbs.)	Rare†	20–24	325°F	140°F
		Medium	24–28	325°F	160°F
		Well	28–32	325°F	170°F
	Boneless Rib, Top Sirloin	Rare†	20–24	325°F	140°F
		Medium	24–28	325°F	160°F
		Well	28–32	325°F	170°F
	Beef Tenderloin	Rare†	10–14	325°F	140°F
		Medium	14–18	325°F	160°F
	Pot Roast (2½ to 3 lbs.) chuck, rump		35–45	300°F	170°F
Pork	Bone-in (3 to 5 lbs.)		23–27	325°F	170°F
	Boneless (3 to 5 lbs.)		23–27	325°F	170°F
	Pork Chops (½ to 1" thick)	2 chops	30–35 total	325°F	170°F
		4 chops	35–40 total	325°F	170°F
6 chops		40–45 total	325°F	170°F	
Ham	Canned (3 lbs. fully cooked)		14–18	325°F	140°F
	Butt (5 lbs. fully cooked)		14–18	325°F	140°F
	Shank (5 lbs. fully cooked)		14–18	325°F	140°F
Lamb	Bone-in (3 to 5 lbs.)	Medium	17–20	325°F	160°F
		Well	20–24	325°F	170°F
	Boneless (3 to 5 lbs.)	Medium	17–20	325°F	160°F
		Well	20–24	325°F	170°F
Seafood	Fish, whole (3 to 5 lbs.)		30–40 total	400°F	
	Lobster Tails (6 to 8 oz. each)		20–25 total	350°F	
Poultry	Whole Chicken (2½ to 3½ lbs.)		24–26	350°F	180°–185°F
	Cornish Hens Unstuffed (1 to 1½ lbs.)		50–55 total	350°F	180°–185°F
	Cornish Hens Stuffed (1 to 1½ lbs.)		55–60 total	350°F	180°–185°F
	Duckling (4 to 5 lbs.)		24–26	325°F	180°–185°F
	Turkey, whole*	Unstuffed (10 to 16 lbs.)		8–11	325°F
Unstuffed (18 to 24 lbs.)			7–10	325°F	180°–185°F
Turkey Breast (4 to 6 lbs.)			16–19	325°F	170°F

* Stuffed birds generally require 30–45 minutes additional roasting time. Shield legs and breast with foil to prevent overbrowning and drying of skin.

† The U.S. Department of Agriculture says "Rare beef is popular, but you should know that cooking it to only 140°F means some food poisoning organisms may survive." (Source: *Safe Food Book. Your Kitchen Guide.* USDA Rev. June 1985.)

Using the timed convection baking features.

You will hear a fan while cooking with this feature. The fan will stop when the door is opened but the heat will not turn off.

NOTE: Foods that spoil easily—such as milk, eggs, fish, stuffings, poultry and pork—should not be allowed to sit for more than 1 hour before or after cooking. Room temperature promotes the growth of harmful bacteria. Be sure that the oven light is off because heat from the bulb will speed harmful bacteria growth.

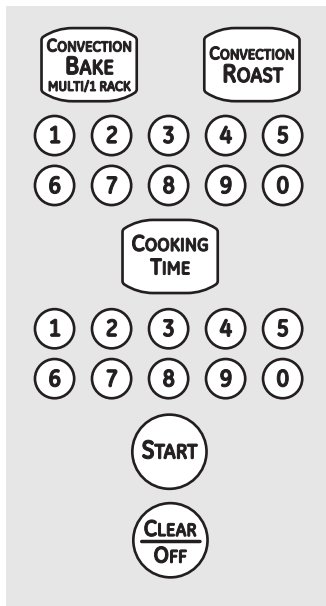

How to Set an Immediate Start and Automatic Stop

The upper oven will turn on immediately and cook for a selected length of time. At the end of the cooking time, the oven will turn off automatically.

- 1 Touch the **CONVECTION BAKE MULTI/1 RACK** pad once for multi-rack convection baking. This mode is used for cooking food items on more than one rack (i.e., 2, 3 or more racks) at the same time in convection bake. See the *Multi-Rack Baking* section for more information. Touch the **CONVECTION BAKE MULTI/1 RACK** pad twice for one rack convection baking. This mode is used for cooking food items on only one rack in convection bake.

Touch the **CONVECTION ROAST** pad for convection roasting.

- 2 Touch the number pads to set the desired oven temperature.
- 3 Touch the **COOKING TIME** pad.

NOTE: If your recipe requires preheating, you may need to add additional time to the length of the cooking time.

- 4 Touch the number pads to set the desired length of cooking time. The minimum cooking time you can set is 1 minute.

The oven temperature that you set and the cooking time that you entered will be in the display.

- 5 Touch the **START** pad.

The oven will turn **ON**, and the display will show the cooking time countdown and the changing temperature starting at 100°F. (The temperature display will start to change once oven temperature reaches 100°F.) When the oven reaches the temperature you set, 3 beeps will sound.

The oven will continue to cook for the set amount of time, then turn off automatically.

After the oven turns off, the end-of-cycle tone will sound.

- 6 Touch the **CLEAR/OFF** pad to clear the display if necessary. Remove the food from the oven. Remember, even though the oven turns off automatically, food left in the oven will continue cooking after the oven turns off.

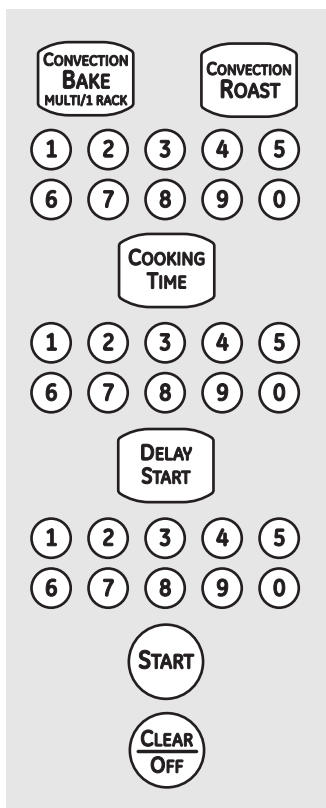

How to Set a Delayed Start and Automatic Stop

The upper oven will turn on at time of day you set, cook for a specific length of time and then turn off automatically.

Make sure the clock shows correct time of day.

- 1 Touch the **CONVECTION BAKE MULTI/1 RACK** pad once for multi-rack convection baking. This mode is used for cooking food items on more than one rack (i.e., 2, 3 or more racks) at the same time in convection bake. See the *Multi-Rack Baking* section for more information. Touch the **CONVECTION BAKE MULTI/1 RACK** pad twice for one rack convection baking. This mode is used for cooking food items on only one rack in convection bake.

Touch the **CONVECTION ROAST** pad for convection roasting.

- 2 Touch the number pads to set the desired oven temperature.
- 3 Touch the **COOKING TIME** pad.

NOTE: If your recipe requires preheating, you may need to add additional time to the length of the cooking time.

- 4 Touch the number pads to set the desired length of cooking time. The minimum cooking time you can set is 1 minute.

The oven temperature that you set and the cooking time that you entered will be in the display.

- 5 Touch the **DELAY START** pad.

- 6 Touch the number pads to set time of day you want oven to turn on and start cooking.

- 7 Touch the **START** pad.

NOTE: If you would like to check the times you have set, touch the **DELAY START** pad to check the start time you have set or touch the **COOKING TIME** pad to check the length of cooking time you have set.

When the oven turns **ON** at the time of day you set, the display will show the cooking time countdown and the changing temperature starting at 100°F. (The temperature display will start to change once the oven temperature reaches 100°F.) When the oven reaches the temperature you set, 3 beeps will sound.

The oven will continue to cook for the set amount of time, then turn off automatically.

After the oven turns off, the end-of-cycle tone will sound.

- 8 Touch the **CLEAR/OFF** pad to clear the display if necessary. Remove the food from the oven. Remember, even though the oven turns off automatically, food left in the oven will continue cooking after the oven turns off.

Special features of your upper oven control.

Your new touch pad control has additional features that you may choose to use. The following are the features and how you may activate them.

The special feature modes can only be activated while the display is showing the time of day. They remain in the control's memory until the steps are repeated.

When the display shows your choice, touch the **START** pad. The special features will remain in memory after a power failure.

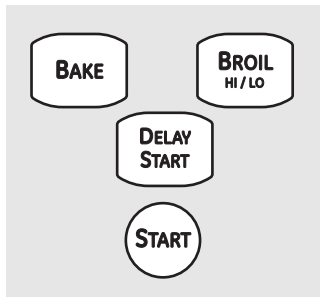

12-Hour Shut-Off

With this feature, should you forget and leave the oven on, the control will automatically turn off the oven after 12 hours during baking functions or after 3 hours during a broil function.

If you wish to turn **OFF** this feature, follow the steps below.

- 1 Touch the **BAKE** and **BROIL HI/LO** pads at the same time for 3 seconds until the display shows **SF**.

- 2 Touch the **DELAY START** pad. The display will show **12 shdn** (12-hour shut-off). Touch the **DELAY START** pad again and the display will show **no shdn** (no shut-off).

- 3 Touch the **START** pad to activate the no shut-off and leave the control set in this special features mode.

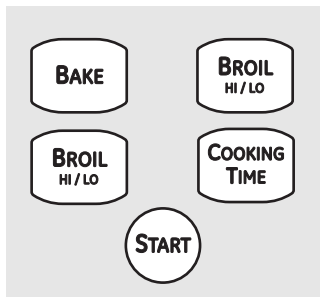

Fahrenheit or Celsius Temperature Selection

Your oven control is set to use the Fahrenheit temperature selections but you may change this to use the Celsius selections.

- 1 Touch the **BAKE** and **BROIL HI/LO** pads at the same time for 3 seconds until the display shows **SF**.

- 2 Touch the **BROIL HI/LO** and **COOKING TIME** pads at the same time. The display will show **F** (Fahrenheit).

- 3 Touch the **BROIL HI/LO** and **COOKING TIME** pads again at the same time. The display will show **C** (Celsius).

- 4 Touch the **START** pad.

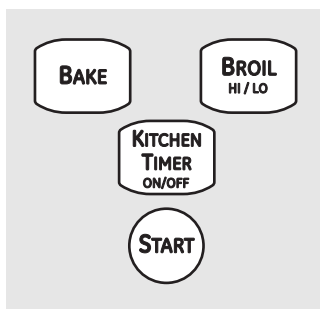

Tones at the End of a Timed Cycle

At the end of a timed cycle, 3 short beeps will sound followed by one beep every 6 seconds until the **CLEAR/OFF** pad is touched. This continual 6-second beep may be canceled.

To cancel the 6-second beep:

- 1 Touch the **BAKE** and **BROIL HI/LO** pads at the same time for 3 seconds until the display shows **SF**.

- 2 Touch the **KITCHEN TIMER ON/OFF** pad. The display shows **CON BEEP** (continual beep) and **BEEP**. Touch the **KITCHEN TIMER ON/OFF** pad again. The display shows **BEEP**. (This cancels the one beep every 6 seconds.)

- 3 Touch the **START** pad.



Gas/Control Lockout (on some models)

Your control will allow you to lock out the surface burners, oven burners and control panel so they cannot be activated.

To lock/unlock the controls:

- 1 Turn all surface burners off.
- 2 Touch and hold the **GAS/CONTROL LOCKOUT** pad for 3 seconds until the display shows **LOC**.
- 3 To unlock the control, touch and hold the **GAS/CONTROL LOCKOUT** pad for 3 seconds until **LOC** disappears from the display.

When this feature is on and the touch pads are touched, the control will beep and the display will show **LOC**.

- The control lock-out mode affects all controls. No controls will work when this feature is activated.
- The adjustment will be retained in memory after a power failure.

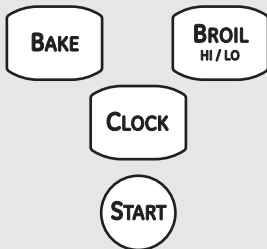

12-Hour, 24-Hour or Clock Blackout

Your control is set to use a 12-hour clock.

If you would prefer to have a 24-hour military time clock or black out the clock display, follow the steps below.

- 1 Touch the **BAKE** and **BROIL HI/LO** pads at the same time for 3 seconds until the display shows **SF**.
- 2 Touch the **CLOCK** pad once. The display will show **12 hr**. If this is the choice you want, touch the **START** pad.

Touch the **CLOCK** pad again to change to the 24-hour military time clock. The display will show **24 hr**. If this is the choice you want, touch the **START** pad.

Touch the **CLOCK** pad again to black out the clock display. The display will show **OFF**. If this is the choice you want, touch the **START** pad.

NOTE: If the clock is in the black-out mode, you will not be able to use the Delay Start function.

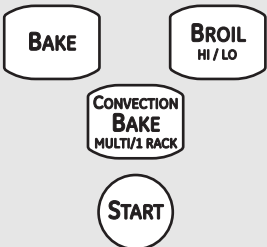

Auto Recipe™ Conversion

You can use your favorite recipes in the convection oven.

When using **CONVECTION BAKE**, the oven will automatically convert the oven temperature from regular baking to Convection Bake temperatures.

The display will show the actual converted (reduced) temperature. For example, if you enter a regular recipe temperature of 350°F (177°C) and touch the **START** pad, the display will show **CON** and the converted temperature of 325°F (163°C).

NOTE: This feature only converts cooking temperatures, not cooking times. When convection roasting, the oven temperature will not auto convert.

To turn off this feature:

- 1 Touch the **BAKE** and **BROIL HI/LO** pads at the same time for 3 seconds until the display shows **SF**.
- 2 Touch the **CONVECTION BAKE MULTI/1 RACK** pad. The display will show **CON ON**. Touch the **CONVECTION BAKE MULTI/1 RACK** pad again. The display will show **CON OFF**.
- 3 Touch the **START** pad.

To turn on this feature, repeat steps 1–3 above but touch the **START** pad when **CON ON** is in the display.

- Use pan size recommended in the recipe.
- Some package instructions for frozen casseroles, main dishes or baked goods have been developed using commercial convection ovens. For best results in this oven, preheat the oven and use the temperature, for regular baking, on the package.

Using the Sabbath Feature.

(Designed for use on the Jewish Sabbath and Holidays)

The Sabbath feature can be used for baking/roasting in the upper oven only. It cannot be used for convection, broiling, self-cleaning or Delay Start cooking.

NOTE: The oven light comes on automatically when the door is opened and goes off when the door is closed. The bulb may be removed. See the Oven Light Replacement section.

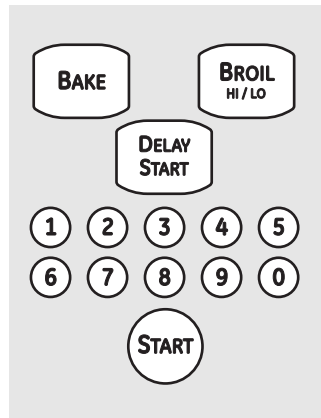

When the display shows \supset the oven is set in Sabbath. When the display shows $\supset \subset$ the oven is baking/roasting.

How to Set for Regular Baking/Roasting

Make sure the clock shows the correct time of day and the oven is off.

- 1 Press and hold **both** the **BAKE** and **BROIL HI/LO** pads, **at the same time**, until the display shows **SF**.
- 2 Tap the **DELAY START** pad until **SAb bAtH** appears in the display.
- 3 Touch the **START** pad and \supset will appear in the display.
- 4 Touch the **BAKE** pad. No signal will be given.
- 5 Using the number pads, enter the desired temperature between 170° and 550°. No signal or temperature will be given.

- 6 Touch the **START** pad.
- 7 After a random delay period of approximately 30 seconds to 1 minute, $\supset \subset$ will appear in the display indicating that the oven is baking/roasting. If $\supset \subset$ doesn't appear in the display, start again at Step 4.

To adjust the oven temperature, touch the **BAKE** pad, enter the new temperature using the number pads, and touch the **START** pad.

NOTE: The **CLEAR/OFF** and **COOKING TIME** pads are active during the Sabbath feature.

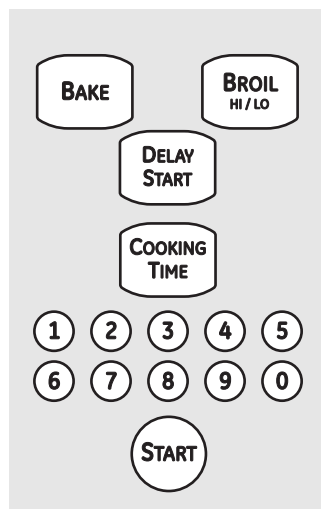

When the display shows \supset the oven is set in Sabbath. When the display shows $\supset \subset$ the oven is baking/roasting.

How to Set for Timed Baking/Roasting—Immediate Start and Automatic Stop

Make sure the clock shows the correct time of day and the oven is off.

- 1 Press and hold **both** the **BAKE** and **BROIL HI/LO** pads, **at the same time**, until the display shows **SF**.
- 2 Tap the **DELAY START** pad until **SAb bAtH** appears in the display.
- 3 Touch the **START** pad and \supset will appear in the display.
- 4 Touch the **COOKING TIME** pad.
- 5 Touch the number pads to set the desired length of cooking time between 1 minute and 9 hours and 99 minutes. The cooking time that you entered will be displayed.
- 6 Touch the **START** pad.
- 7 Touch the **BAKE** pad. No signal will be given.

- 8 Using the number pads, enter the desired temperature. No signal or temperature will be given.
- 9 Touch the **START** pad.
- 10 After a random delay period of approximately 30 seconds to 1 minute, $\supset \subset$ will appear in the display indicating that the oven is baking/roasting. If $\supset \subset$ doesn't appear in the display, start again at Step 7.

To adjust the oven temperature, touch the **BAKE** pad, enter the new temperature using the number pads, and touch the **START** pad.

When cooking is finished, the display will change from $\supset \subset$ to \supset and **0:00** will appear, indicating that the oven has turned **OFF** but is still set in Sabbath. Remove the cooked food.

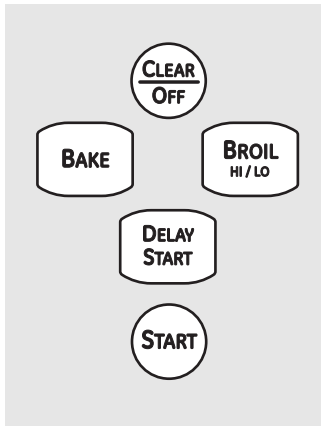

How to Exit the Sabbath Feature

- 1 Touch the **CLEAR/OFF** pad.
- 2 If the oven is cooking, wait for a random delay period of approximately 30 seconds to 1 minute, until only \Rightarrow is in the display.
- 3 Press and hold **both** the **BAKE** and **BROIL HI/LO** pads, **at the same time**, until the display shows **SF**.
- 4 Tap the **DELAY START** pad until **12 shdn** or **no shdn** appears in the display. **12 shdn** indicates that the oven will automatically turn off after 12 hours. **no shdn** indicates that the oven will not automatically turn off.
- 5 Touch the **START** pad.

NOTE: If a power outage occurred while the oven was in Sabbath, the oven will automatically turn off and stay off even when the power returns. The oven control must be reset.

Adjust the upper oven thermostat—Do it yourself!

You may find that your new oven cooks differently than the one it replaced. Use your new oven for a few weeks to become more familiar with it. If you still think your new oven is too hot or too cold, you can adjust the thermostat yourself.

Do not use thermometers, such as those found in grocery stores, to check the temperature setting of your oven. These thermometers may vary 20–40 degrees.

NOTE: This adjustment will not affect the broiling or the self-cleaning temperatures. The adjustment will be retained in memory after a power failure.

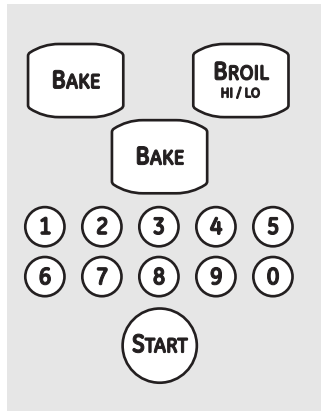

To Adjust the Thermostat

1 Touch the **BAKE** and **BROIL HI/LO** pads at the same time for 3 seconds until the display shows **SF**.

2 Touch the **BAKE** pad. A two digit number shows in the display.

Touch **BAKE** once to decrease (-) the oven temperature, or twice to increase (+).

3 The oven temperature can be adjusted up as much as 35°F. or down as much as 35°F. Touch the number pads the same way you read them. For example, to change the oven temperature 15°F, touch **1** and **5**.

4 When you have made the adjustment, touch the **START** pad to go back to the time of day display. Use your oven as you would normally.

NOTE: The thermostat adjustment for Baking will also affect Convection Baking or Convection Roasting.

The type of margarine will affect baking performance!

Most recipes for baking have been developed using high fat products such as butter or margarine (80% fat). If you decrease the fat, the recipe may not give the same results as with a higher fat product.

Recipe failure can result if cakes, pies, pastries, cookies or candies are made with low fat spreads. The lower the fat content of a spread product, the more noticeable these differences become.

Federal standards require products labeled "margarine" to contain at least 80% fat by weight. Low fat spreads, on the other hand, contain less fat and more water. The high moisture content of these spreads affects the texture and flavor of baked goods. For best results with your old favorite recipes, use margarine, butter or stick spreads containing at least 70% vegetable oil.

Using the lower oven drawer.

The lower oven drawer may be used to bake foods using the same times and temperatures as a standard oven. Foods ideal for baking in the lower oven drawer include pizza, frozen foods, casseroles, biscuits, rolls and many desserts.

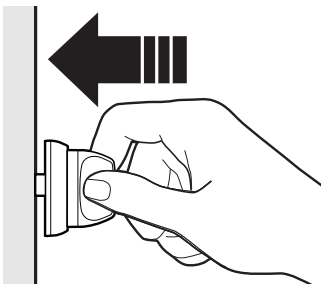
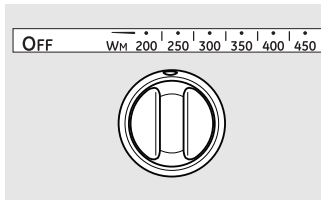

Push in and turn the lower oven drawer knob to any desired setting.

To Use the Lower Oven Drawer

- 1 Push in and turn the lower oven drawer knob to any desired setting.
- 2 Allow the lower oven drawer to preheat.
 - The ON signal light is located on the upper right side of the knob and glows when the knob is in the ON position. It remains ON until the knob is moved to the OFF position.
 - The "Heating" signal light is located below the ON signal light and glows when the heating elements are active. Preheat is complete after the "Heating" signal has turned off for the first time each use.

NOTES:

- Always use the included drawer rack when using the lower oven drawer.
- The lower oven drawer cannot be used during a self-clean cycle of the upper oven.
- Do not put food, foil or cookware directly on the bottom of the lower oven drawer. Always use the included drawer rack.
- If foods require a cover, use only foil or lids able to withstand baking temperatures. Do not use plastic.
- Maximum height of foods that can be placed in the lower oven drawer is 4 .
- Do not put liquid or water in the lower oven drawer.
- Never place plastics, paper, canned foods or combustible material in the lower oven drawer.

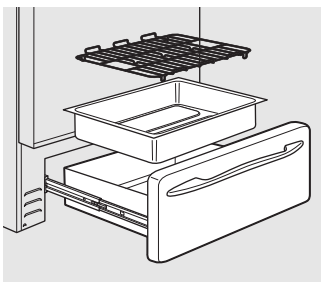

The lower oven drawer uses less energy than the upper oven. Allow the following approximate times for preheating:

Desired Lower Oven Temperature	Preheat Time
WARM	10 minutes
350° F	20 minutes
425° F	30 minutes

Adjust the oven thermostat—Do it yourself!

You may find that your new oven cooks differently than the one it replaced. Use your new oven for a few weeks to become more familiar with it. If you still think your new oven is too hot or too cold, you can adjust the thermostat yourself.

Do not use thermometers, such as those found in grocery stores, to check the temperature setting of your oven. These thermometers may vary 20–40 degrees.

NOTE: This adjustment will not affect the broiling temperatures.

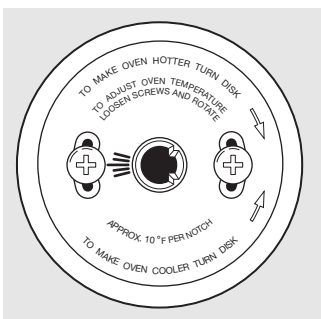

Back of Lower Oven Knob
(Appearance may vary.)

- 1 Pull the **OVEN CONTROL** knob off the range and look at the back side. To make an adjustment, loosen (approximately one turn), but do not completely remove, the two screws on the back of the knob.
- 2 With the back of the knob facing you, hold the outer edge of the knob with one hand and turn the front of the knob with the other hand.
 - To raise the oven temperature, move the top screw toward the right. You'll hear a click for each notch you move the knob.
 - To lower the temperature, move the top screw toward the left.

Each click will change the oven temperature approximately 10°F. (Range is ± 60°F. from the arrow.) We suggest that you make the adjustment one click from the original setting and check oven performance before making any additional adjustments.

- 3 After the adjustment is made, retighten screws so they are snug, but be careful not to overtighten.
- 4 Re-install knob on range and check performance.

Using the self-cleaning upper oven.

The oven door must be closed and all controls set correctly for the cycle to work properly.

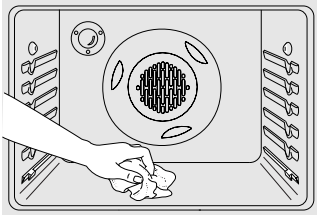

Wipe up heavy soil on the oven bottom.

Before a Clean Cycle

For the first self-clean cycle, we recommend venting your kitchen with an open window or using a ventilation fan or hood.

Remove any broiler pan, broiler grid, all cookware, probe and any aluminum foil from the oven—they cannot withstand the high cleaning temperatures.

NOTE:

- The gray porcelain-coated oven racks may be left in the oven during the self-clean cycle.

Soil on the front frame of the range and outside the gasket on the door will need to be cleaned by hand. Clean these areas with hot water, soap-filled scouring pads or cleansers such as Soft Scrub®. Rinse well with clean water and dry.

Do not clean the gasket. The fiberglass material of the oven door gasket cannot withstand abrasion. It is essential for the gasket to remain intact. If you notice it becoming worn or frayed, replace it.

Wipe up any heavy spillovers on the oven bottom.

Make sure the oven light bulb cover is in place and the oven light is off.

IMPORTANT: The health of some birds is extremely sensitive to the fumes given off during the self-cleaning cycle of any range. Move birds to another well ventilated room.

NOTE: Use caution when opening the upper oven after the self-clean cycle has ended. The oven may still be hot.

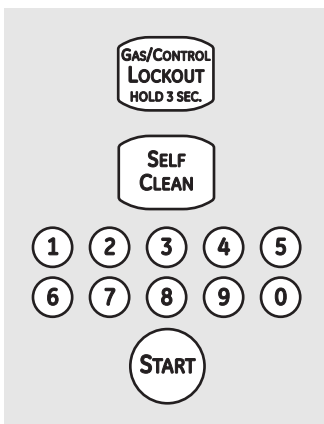

How to Set the Upper Oven for Cleaning

- 1 Turn all surface burners off.
NOTE: The surface burners will not function during self-clean cycle.
- 2 Touch the **SELF CLEAN** pad.
- 3 Using the number pads, enter the desired clean time, if a time other than 4 hours is needed.

Clean cycle time is normally 4 hours. You can change the clean time to any time between 3 hours and 5 hours, depending on how dirty your oven is.

- 4 Touch the **START** pad.

The door and control will lock automatically. The display will show the clean time remaining. It will not be possible to open the oven door until the temperature drops below the lock temperature and the **LOCKED DOOR** light goes off.

The oven shuts off automatically when the clean cycle is complete.

- 5 When the **LOCKED DOOR** light is off, the door will unlock automatically.

- The words **LOCK DOOR** will flash and the oven control will signal if you set the clean cycle and forget to close the oven door.
- To stop a clean cycle, touch the **CLEAR/OFF** pad. When the **LOCKED DOOR** light goes off indicating the oven has cooled below the locking temperature, you may open the door.
- Do not use the lower oven drawer during a self-clean cycle.
- The words **ERR** and **TURN SURFACE BURNERS OFF** will flash and the control will signal if you set the clean cycle and forget to turn the surface burners off.

The oven door must be closed and all controls set correctly for the cycle to work properly.

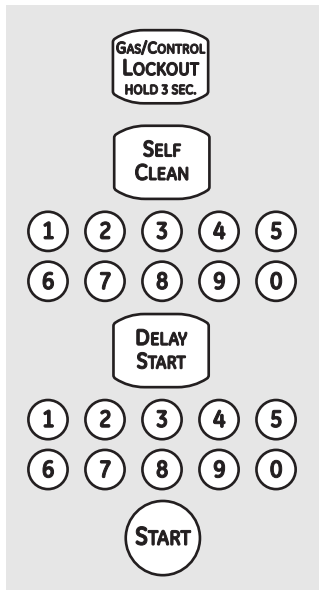

How to Delay the Start of Cleaning

Make sure the clock shows the correct time of day.

- 1 Touch and hold the **GAS/CONTROL LOCKOUT** pad for 3 seconds to turn it off.

NOTE: The surface burners must be turned off prior to the self-clean start time.

- 2 Touch the **SELF CLEAN** pad.
- 3 Using the number pads, enter the desired clean time.
- 4 Touch the **DELAY START** pad. The earliest start time you can set will appear in the display.
- 5 Using the number pads, enter the time of day you want the clean cycle to start.
- 6 Touch the **START** pad.

The door locks automatically. The display will show the start time. It will not be possible to open the oven door until the temperature drops below the lock temperature and the **LOCKED DOOR** light goes off.

The oven shuts off automatically when the clean cycle is complete.

- 7 When the **LOCKED DOOR** light is off, the door will unlock automatically.
 - The words **LOCK DOOR** will flash and the oven control will signal if you set the clean cycle and forget to close the oven door.
 - To stop a clean cycle, touch the **CLEAR/OFF** pad. When the **LOCKED DOOR** light goes off indicating the oven has cooled below the locking temperature, you may open the door.

After a Clean Cycle

You may notice some white ash in the oven. Wipe it up with a damp cloth after the oven cools.

If white spots remain, remove them with a soap-filled scouring pad and rinse thoroughly with a vinegar and water mixture.

These deposits are usually a salt residue that cannot be removed by the clean cycle.

If the oven is not clean after one clean cycle, repeat the cycle.

- You cannot set the oven for cooking until the oven is cool enough for the door to unlock.
- While the oven is self-cleaning, you can touch the **CLOCK** pad to display the time of day. To return to the clean countdown, touch the **COOKING TIME** pad.
- If the racks become hard to slide, apply a small amount of vegetable oil or cooking oil to a paper towel and wipe the edges of the oven racks with the paper towel.

Care and cleaning of the range.

Be sure electrical power is off and all surfaces are cool before cleaning any part of the range.

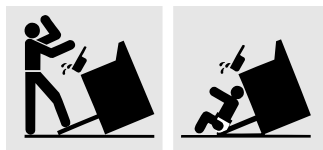

⚠ WARNING: If your range is removed for cleaning, servicing or any reason, be sure the anti-tip device is re-engaged properly when the range is replaced. Failure to take this precaution could result in tipping of the range and cause injury.

Front right burner

Turn all controls **OFF** before removing the burner parts.

The round side burner caps and burner heads can be lifted off, making them easy to clean. The electrodes are not removable.

The oval center burner head and cap assembly can be lifted off, making it easy to clean. The burner electrode is not removable.

Make sure the hole in the burner head is positioned over the electrode and that the burner head is fully inserted inside the burner base. A small gap between the base and head is normal.

Sealed Burner Assemblies

Turn all controls **OFF** before removing the burner parts.

The round side burner caps and burner heads can be lifted off, making them easy to clean. The electrodes are not removable.

The oval center burner head and cap assembly can be lifted off, making it easy to clean. The burner electrode is not removable.

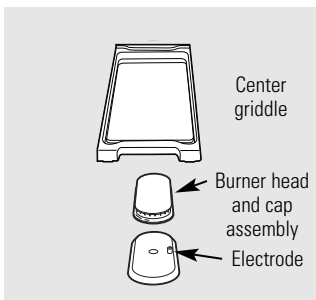

⚠ CAUTION: Do not operate the cooktop without all burner parts and grates in place.

The electrode of the spark igniter is exposed when the burner head is removed. When one burner is turned to **LITE**, all the burners spark. Do not attempt to disassemble or clean around any burner while another burner is on. An electric shock may result, which could cause you to knock over hot cookware.

Front left burner, back right burner and back left burner

Use a sewing needle or twist-tie to unplug the small hole in the burner head.

Make sure the slot in the burner head is positioned over the electrode.

Burner Caps and Heads

Before removing the burner caps and heads, remember their size and location. Replace them in the same location after cleaning.

NOTE: Do not use steel wool or scouring powders to clean the burner parts.

Burner caps



Lift off when cool. Wash burner caps in hot, soapy water and rinse with clean water. You may scour with a plastic scouring pad to remove burned-on food particles.

Burner Heads and Oval (Center) Burner Head/Cap Assembly

The burner heads and the oval burner head/cap assembly are removable. Simply lift them off the range for cleaning.

For proper ignition, make sure the small hole in the section that fits over the electrode is kept open. A sewing needle or wire twist-tie works well to unclog it.

The slits in the burner heads must be kept clean at all times for an even, unhampered flame.

Clogged or dirty burner ports or electrodes will not allow the burner to operate properly.

Any spill on or around an electrode must be carefully cleaned. Take care to not hit an electrode with anything hard or it could be damaged.

Clean the burner heads routinely, especially after bad spillovers, which could clog the openings. Lift off when cool. To remove burned-on food, soak the burner heads in a solution of mild liquid detergent and hot water for 20–30 minutes. For more stubborn stains, use a toothbrush.

After cleaning

Before putting the burner caps, heads and oval head/cap assembly back, shake out excess water and then dry them thoroughly by setting in a warm oven for 30 minutes.

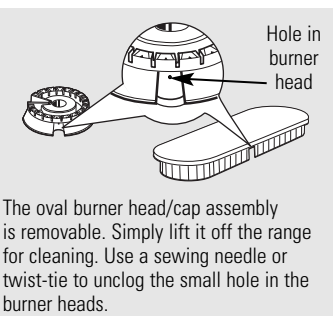
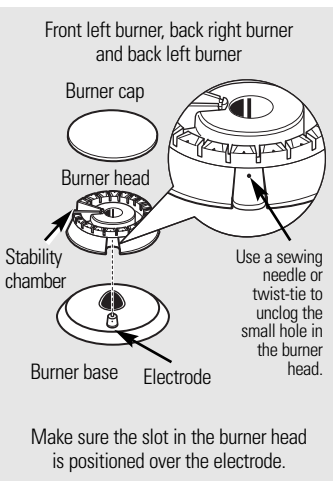
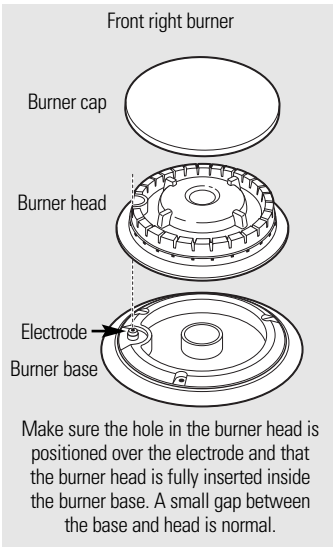

Replacement

Burner Heads

Replace burner heads over the electrodes on the cooktop, in the correct locations according to their size. There is one small, one medium, one extra large and one dual flame extra large burner head.

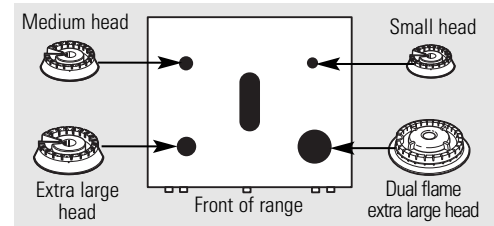

Make sure the slot (on front left, back right and back left heads) and the hole (front right head) in the burner head is positioned over the electrode.

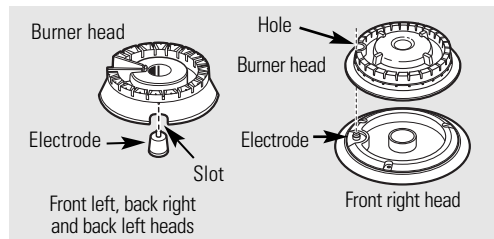

Oval (Center) Burner Head/Cap Assembly

Replace the oval (center) head/cap assembly over the electrode on the cooktop.

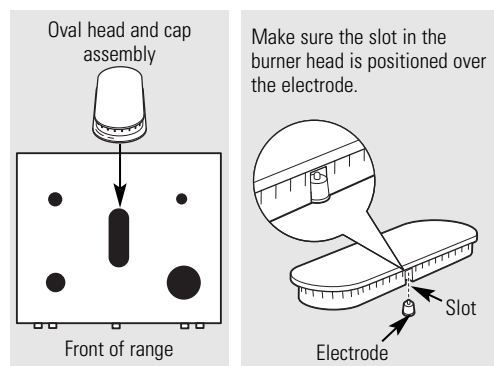

Caps

Replace the matching size caps onto the burner bases or heads.

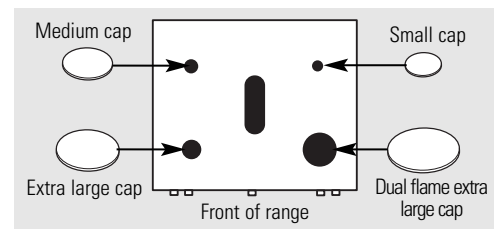

Make sure that the heads and caps are replaced in the correct locations.

Care and cleaning of the range.

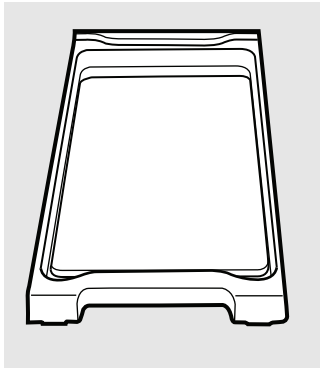

Griddle

NOTES:

- The griddle is to be used over the center burner only.
- Do not clean the griddle in a self-cleaning oven.
- Do not clean the griddle in a dishwasher.
- Wash with hot, soapy water after each use while using a sponge or dishcloth.
- If oil or food residue is left on the griddle, further cooking will harden the residue and cause sticking over time. In this case, use a non-abrasive cleanser such as Bon Ami® or one of the soft scrub cleansers. Apply with a sponge, Scrunge® or other cleaning pad labeled safe for non-stick pans
- Use only plastic, nylon or wooden utensils or SilverStone® kitchen tools to prevent marring of the coating.

- Never use knives or cut food on the griddle. Wash with hot, soapy water after each use. Store carefully to prevent scratching.

Griddle Precautions:

- If something has spilled under the griddle, it should be cleaned up as soon as possible to prevent "baked on" food soil.
- Do not allow grease to accumulate under the griddle as it can be a fire hazard. Clean under the griddle as soon as it is cool. Clean with hot soapy water.
- Do not place your griddle in the microwave.
- Always turn off all surface burners before removing the griddle. Use caution when handling a hot griddle.

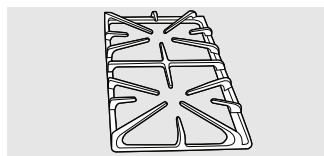

Appearance may vary.

The grates may be cleaned in a dishwasher.

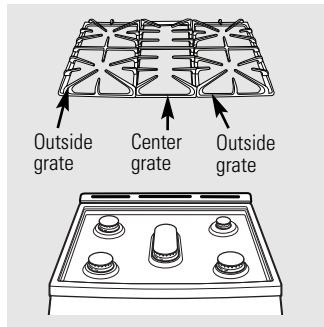

Burner Grates

Your range has three professional-style double grates. These grates are position-specific. For maximum stability, these grates should only be used in their proper positions. For convenience, the undersides of the side grates are marked "OUTSIDE." Make sure the front portion of both grates is in front. The center grate can be interchanged front to back.

If white spots remain, remove them with a soap-filled scouring pad and rinse thoroughly with a vinegar and water mixture. These deposits are usually a salt residue that cannot be removed by the clean cycle.

Cleaning Grates—Soap and Water

Lift grates out when cool. Grates should be washed regularly and, of course, after spills. Wash them in hot, soapy water and rinse with clean water. When replacing the grates, be sure they are positioned securely over the burners. Replace the grates so that straight lines are formed with the center ribs of all three grates.

Cleaning Grates—Dishwasher

The grates may be cleaned in the dishwasher. Remove any burnt-on food particles that you can prior to placing the grates in the dishwasher. Place them on the lowest rack of the dishwasher and run on a "heavy duty" cycle.

Do not operate a burner for an extended period of time without cookware on the grate. The finish on the grate may chip without cookware to absorb the heat.

Although the grates are durable, they will gradually lose their shine, regardless of the best care you can give them. This is due to their continual exposure to high temperatures and abrasion by the cookware.

Cleaning Grates—Self-Clean Oven

To get rid of burned-on food, you may use the self-clean cycle of your range. Remove any burnt-on food particles that you can prior to placing the grates in the oven. Place the gray porcelain-coated racks in positions "R", "B" and "D".

NOTE: Do not clean the griddle in the self-cleaning oven.

Place one grate each on the oven racks from side to side. Follow the instructions for how to set the upper oven for cleaning.

NOTE: Use caution when removing the grates from the oven after the self-clean cycle has ended. The grates may still be hot.

For heavily-soiled grates, you may notice some white ash on the grate. Wipe it off with a damp cloth after the grate cools.

Support Bumpers

If one or more of the circular silicone grate support bumpers in the cooktop are missing or damaged, replacement parts can be obtained by calling 1.800.GE.CARES.

To insert the new bumpers, simply insert the cone shaped end and push down while gently twisting or rocking the bumper.

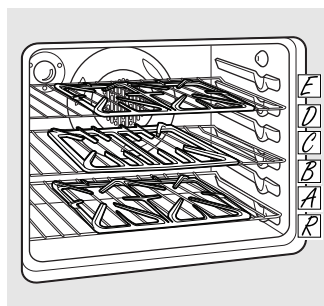

The oven has 5 rack positions. Place the gray porcelain-coated racks in positions "R", "B" and "D" for self-cleaning the grates. Place one grate each on the oven racks from side to side.

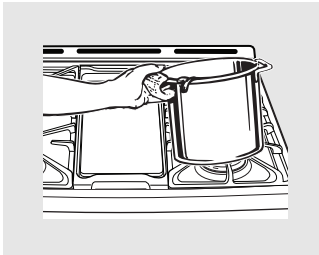

Cooktop Surface

To avoid damaging the stainless steel surface of the cooktop and to prevent it from becoming dull, clean up spills right away. Foods with a lot of acid (tomatoes, sauerkraut, fruit juices, etc.) or foods with high sugar content could cause a dull spot if allowed to set.

When the surface has cooled, wash and rinse. For other spills such as fat splatterings, etc., wash with soap and water once the surface has cooled. Then rinse and polish with a dry cloth.

NOTE: Do not store flammable materials in an oven, drawer or near the cooktop. Do not store or use combustible materials, gasoline or other flammable vapors and liquids in the vicinity of this or any other appliance.

NOTE: Do not lift the cooktop. Lifting the cooktop can lead to damage and improper operation of the range.

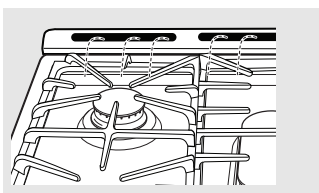

Oven Air Vents

Never block the vents (air openings) of the range. They provide the air inlet and outlet that are necessary for the range to operate properly with correct combustion.

Air openings are located at the rear of the cooktop, at the top and bottom of the oven door, and at the bottom of the range, under the lower cooking drawer.

Vent appearance and location vary.



Upper Control Panel

See the *Gas/Control Lockout* information in the *Special features of your oven control* section in this manual.

Remove heavier soil with warm soapy water. Do not use abrasives of any kind.

Clean up splatters with a damp cloth.

Unlock the touch pads after cleaning.

You may also use a glass cleaner.

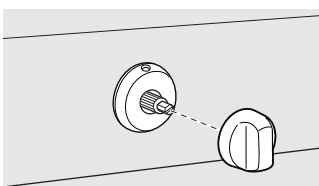

Surface burner knob

Lower Control Panel (Front Manifold Panel) and Knobs

It's a good idea to wipe the control panel after each use of the oven. Use a damp cloth to clean or rinse. For cleaning, use mild soap and water or a 50/50 solution of vinegar and water. For rinsing, use clean water. Polish dry with a soft cloth.

Make sure the knobs are in the **OFF** positions and pull them straight off the stems for cleaning.

Do not use abrasive cleansers, strong liquid cleaners, plastic scouring pads or oven cleaners on the control panel—they will damage the finish.

The knobs can be cleaned in a dishwasher or they may also be washed with soap and water. Make sure the insides of the knobs are dry before replacing.

Do not try to bend knobs by pulling them up or down or by hanging a towel or other such loads. This can damage the gas valve shaft.

Replace the knobs in the **OFF** position to ensure proper placement.

The control knobs may be removed for easier cleaning.

Metal parts can be cleaned with soap and water. Do not use steel wool, abrasives, ammonia, acids or commercial oven cleaners. Dry with a soft cloth.

NOTE: The lower oven drawer control knob is not interchangeable with the surface burner knobs. Be sure to reinstall the lower oven drawer knob to the original location. The lower oven drawer knob may be identified by the increasing numbers from "W_M" to "450."

Care and cleaning of the range.

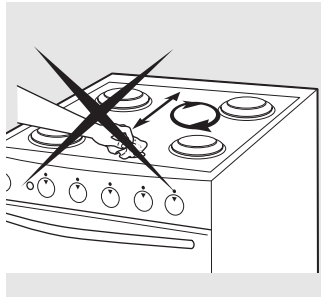
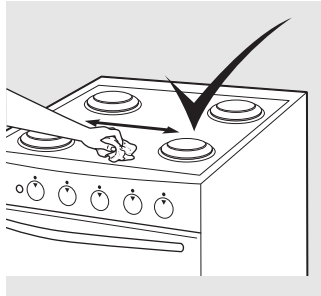

Stainless Steel Surfaces (on some models)

Protecting

STAINLESS STEEL has a reputation for withstanding tough abuse for years. This is a key reason why it is so popular with the food service industry.

However, stainless steel appliances can have surface imperfections, discolorations or blemishes that consumers with a critical eye notice and find unattractive in the home. These discolorations or blemishes can be caused by something as simple as leaving fingerprint smudges on the stainless steel surface overnight.

For stainless steel appliances where blemishes are prone to show on the surface, we recommend APPLYING A COAT OF CERAMA BRYTE® Stainless Steel Cleaning Polish & Conditioner (purchased separately—follow instructions).

This will help you to maintain the brightness and appearance of your stainless steel appliance.

Cleaning

Do not use a steel wool pad; it will scratch the surface.

- In order to avoid any discolorations and/or grease stains, we recommend cleaning and removing any spills, spots and grease from the range after use.
- It is important to use a soft cloth or paper towel every time the range is cleaned to avoid any scratches.

Read carefully the instructions on the back of the Brightener (included with your range) for better results.

Cleaning Instructions:

- 1 Remove grates.
- 2 Wash using warm, soapy water:
 - Wet soft cloth or paper towel (avoid using excessive water).
 - Wipe the surface in the direction of the grain (following the steel lines).
 - Rinse and wring out a soft cloth or paper towel and dry the range.
- 3 Apply a degreaser that does not contain sodium hydroxide or Stainless Steel Cleaner (follow instructions).

- 4 Apply Cerama Bryte® Stainless Steel Brightener (follow instructions).
- 5 Repeat steps 2–4 as many times as needed.
- 6 Put grates back in place.

Follow these instructions for any Stainless Steel surface on your range.

DO NOT USE the following products for cleaning the Cooktop or Stainless Steel parts:

- Caustic Lye (Sodium Hydroxide) or cleaners containing this chemical
- Hard or Steel Wool Pads
- Abrasive Materials or Chemicals

To inquire about purchasing stainless steel appliance cleaner or polish, or to find the location of a dealer nearest you, please call our toll-free number:

National Parts Center 800.626.2002 (U.S.)
800.661.1616 (Canada)

GEAppliances.com (U.S.)

www.GEAppliances.ca (Canada)

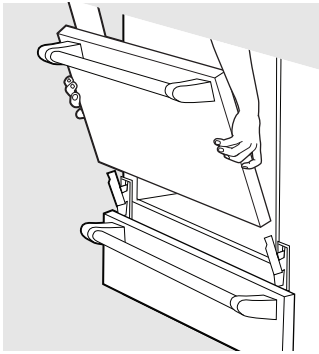

Lift the door straight up and off the hinges.

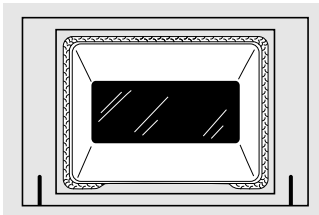

The gasket is designed with a gap at the bottom to allow for proper air circulation.

Do not rub or clean the door gasket—it has an extremely low resistance to abrasion.

If you notice the gasket becoming worn, frayed or damaged in any way or if it has become displaced on the door, you should have it replaced.

Lift-Off Oven Door

The oven door is removable, but it is heavy. You may need help removing and replacing the door.

To remove the door, open it a few inches to the special stop position that will hold the door open. Grasp firmly on each side and lift the door straight up and off the hinges.

NOTE: Be careful not to place hands between the hinge and the oven door frame as the hinge could snap back and pinch fingers.

To replace the door, make sure the hinges are in the special stop position. Position the slots in the bottom of the door squarely over the hinges. Then lower the door slowly and evenly over both hinges at the same time. If the hinges snap back against the oven frame, pull them back out.

To clean the inside of the door:

- Do not allow excess water to run into any holes or slots in the door.
- Because the area inside the gasket is cleaned during the self clean cycle, you do not need to clean this by hand. Any soap left on the liner causes additional stains when the oven is heated.

- The area outside the gasket can be cleaned with a soap-filled plastic scouring pad.

To clean the outside of the door:

- Use soap and water to thoroughly clean the top, sides and front of the oven door. Rinse well. You may also use a glass cleaner to clean the glass on the outside of the door.
- Spillage of marinades, fruit juices, tomato sauces and basting materials containing acids may cause discoloration and should be wiped up immediately. When the surface is cool, clean and rinse.
- Do not use oven cleaners, cleansing powders or harsh abrasives on the outside of the door.

Oven Bottom

The oven bottom has a porcelain enamel finish. To make cleaning easier, protect the oven bottom from excessive spillovers by placing a cookie sheet on the rack below the rack you are cooking on. This is particularly important when baking a fruit pie or other foods with a high acid content. Hot fruit fillings or other foods that are highly acidic (such as tomatoes, sauerkraut and sauces with vinegar or lemon juice) may cause pitting and damage to the porcelain enamel surface and should be wiped up immediately.

We don't recommend using aluminum foil on the oven bottom. It can affect air flow if the holes are blocked and it can concentrate heat at the bottom of the oven, resulting in poor baking performance.

To clean up spillovers, use soap and water, an abrasive cleaner or soap-filled scouring pad. Rinse well to remove any soap before self-cleaning.

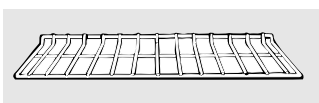

Oven Racks and Drawer Racks

The gray porcelain-coated racks may be cleaned in the oven during the self-clean cycle.

They may also be cleaned by using an abrasive cleanser. After cleaning, rinse the racks with clean water and dry with a clean cloth. If the racks ever become hard to slide, wipe the rack edges or oven rack supports with vegetable oil.

Care and cleaning of the range.

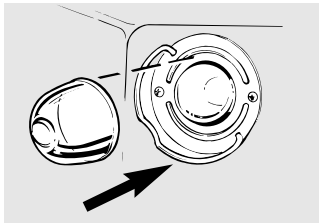

Wire cover holder.

Oven Light Replacement

CAUTION: Before replacing your oven light bulb, disconnect the electrical power to the range at the main fuse or circuit breaker panel. Be sure to let the light cover and bulb cool completely.

The oven light bulb is covered with a removable glass cover that is held in place with a bail-shaped wire. Remove the oven door, if desired, to reach cover easily.

To remove:

- 1 Hold a hand under the cover so it doesn't fall when released. With fingers of the same hand, firmly push back the wire cover holder. Lift off the cover.

Do not remove any screws to remove the cover.

- 2 Do not touch hot bulb with a wet cloth. Replace bulb with a 40-watt household appliance bulb.

To replace cover:

- 1 Place it into the groove of the light receptacle. Pull the wire forward to the center of the cover until it snaps into place. When in place, the wire holds the cover firmly. Be certain the wire is in the depression in the center of the cover.
- 2 Connect electrical power to the range.

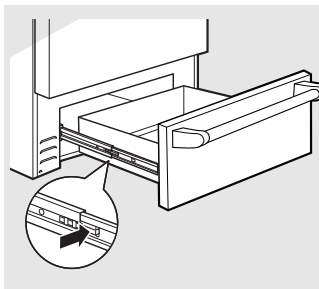

Removable Lower Oven Drawer

NOTE: Before performing any adjustments, cleaning or service, disconnect the range electrical power supply at the household distribution panel by removing the fuse or switching off the circuit breaker. Make sure drawer heating element is cool.

Most cleaning can be done with the drawer in place. However, the drawer may be removed if further cleaning is needed. Use soap and warm water to thoroughly clean.

To remove the drawer:

- 1 Pull the drawer straight out until it stops.
- 2 Press the tabs on both sides in while pulling the drawer forward and free.

To replace the drawer:

- 1 Place the left drawer rail around the inner left rail guide and slide it in slightly to hook it.
- 2 Place the right drawer rail around the inner right rail guide and slide it in slightly to hook it.
- 3 Slide the drawer all the way in.

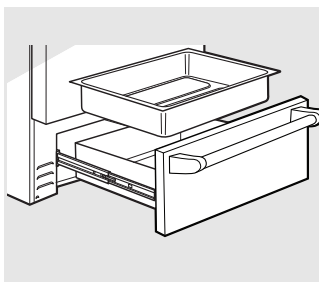
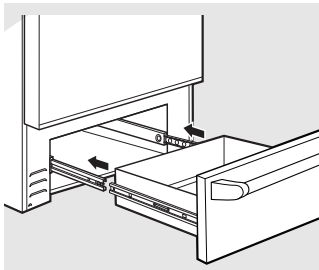

Removable Lower Oven Drawer Pan

NOTE: Before performing any adjustments, cleaning or service, disconnect the range electrical power supply at the household distribution panel by removing the fuse or switching off the circuit breaker. Make sure drawer heating element is cool.

NOTE: Allow lower oven drawer to cool before removing pan.

NOTE: Wipe spills promptly after each use.

- Never place, use or self-clean the lower oven drawer pan in the upper oven.
- Lower oven drawer has a removable pan for easy cleaning. Clean with hot soapy water and a sponge or dish towel. Dry with a clean cloth. An oven cleaner, such as Easy-Off®, may also be used. Be sure to follow the directions on the oven cleaner. Replace the pan in the lower oven drawer.

Installation Instructions

Range

? Questions? Call 800.GE.CARES (800.432.2737) or visit our Website at: GEAppliances.com
In Canada, call 1.800.561.3344 or visit www.GEAppliances.ca

In the Commonwealth of Massachusetts

- This product must be installed by a licensed plumber or gas fitter.
- When using ball type gas shut-off valves, they shall be the T-handle type.
- A flexible gas connector, when used, must not exceed 3 feet.

BEFORE YOU BEGIN

Read these instructions completely and carefully. Installation of this range must conform with local codes, or in the absence of local codes, with the National Fuel Gas Code, ANSI Z223.1/NFPA.54, latest edition. In Canada, installation must conform with the current Natural Gas Installation Code, CAN/CGA-B149.1 or the current Propane Installation Code, CAN/CGA-B149.2, and with local codes where applicable. This range has been design-certified by CSA International according to ANSI Z21.1, latest edition and Canadian Gas Association according to CAN/CGA-1.1 latest edition.

As with any appliance using gas and generating heat, there are certain safety precautions you should follow. You will find these precautions in the *Important Safety Information* section in the front of this manual. Read them carefully.

- **IMPORTANT** – Save these instructions for local electrical inspector's use.
- **IMPORTANT** – Observe all governing codes and ordinances.
- **Note to Installer** – Leave these instructions with the appliance after installation is completed.
- **Note to Consumer** – Keep this Owner's Manual and Installation Instructions for future reference.
- **Note** – This appliance must be properly grounded.
- **Servicer** – The electrical diagram is in an envelope attached to the back of the range.
- **Skill level** – Installation of this appliance requires basic mechanical skills.
- Proper installation is the responsibility of the installer.
- Product failure due to improper installation is not covered under the Warranty.

FOR YOUR SAFETY

Do not store or use combustible materials, gasoline or other flammable vapors and liquids in the vicinity of this or any other appliance.

If you smell gas:

- 1 Open windows.
- 2 Don't touch electrical switches.
- 3 Extinguish any open flame.
- 4 Immediately call your gas supplier.

TOOLS YOU WILL NEED



Phillips screwdriver



Flat-blade screwdriver



Pencil and ruler

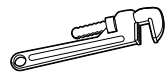

Pipe wrenches (2)
(one for backup)



Open-end or
adjustable wrench



Level



Drill, awl or nail

MATERIALS YOU MAY NEED

- Gas line shut-off valve
- Pipe joint sealant or UL-approved pipe thread tape with Teflon* that resists action of natural and LP gases
- Flexible metal appliance connector (1/2" I.D.)
A 5-foot length is recommended for ease of installation but other lengths are acceptable. Never use an old connector when installing a new range.
- Flare union adapter for connection to gas supply line (3/4" or 1/2" NPT x 1/2" I.D.)
- Flare union adapter for connection to pressure regulator on range (1/2" NPT x 1/2" I.D.)
- Liquid leak detector or soapy water.
- Lag bolt or 1/2" O.D. sleeve anchor (for concrete floors only).

*Teflon: Registered trademark of DuPont

Installation Instructions

⚠ WARNING! **INSTALLATION SAFETY INSTRUCTIONS**

Read these instructions completely and carefully. Improper installation, adjustment, alteration, service or maintenance can cause injury or property damage. Refer to this manual. For assistance or additional information, consult a qualified installer, service agency, manufacturer (dealer) or the gas supplier.

Never reuse old flexible connectors. The use of old flexible connectors can cause gas leaks and personal injury. Always use **NEW** flexible connectors when installing a gas appliance.

IMPORTANT – Remove all packing material and literature from oven before connecting gas and electrical supply to range.

⚠ CAUTION – Do not attempt to operate the oven of this range during a power failure (Electric Ignition models only).

- Have your range installed by a qualified installer.
- Your range must be electrically grounded in accordance with local codes or, in the absence of local codes, in accordance with the National Electrical Code (ANSI/NFPA 70, latest edition). In Canada, electrical grounding must be in accordance with the current CSA C22.1 Canadian Electrical Code Part 1 and/or local codes. See *Electrical Connections* in this section.
- Before installing your range on linoleum or any other synthetic floor covering, make sure the floor covering can withstand 180°F without shrinking, warping or discoloring. Do not install the range over carpeting unless a sheet of 1/4" thick plywood or similar insulator is placed between the range and carpeting.
- Make sure the wall coverings around the range can withstand heat generated by the range up to 200°F.

- Avoid placing cabinets above the range. To reduce the hazard caused by reaching over the open flames of operating burners, install a ventilation hood over the range that projects forward at least 5" beyond the front of the cabinets.

- The ventilating hood must be constructed of sheet metal not less than 0.0122" thick. Install above the cooktop with a clearance of not less than 1/4" between the hood and the underside of the combustible material or metal cabinet. The hood must be at least as wide as the appliance and centered over the appliance. Clearance between the cooking surface and the ventilation hood surface **MUST NEVER BE LESS THAN 24 INCHES.**

EXCEPTION: Installation of a listed microwave oven or cooking appliance over the cooktop shall conform to the installation instructions packed with that appliance.

- If cabinets are placed above the range, allow a minimum clearance of 30" between the cooking surface and the bottom of unprotected cabinets.
- If a 30" clearance between cooking surface and overhead combustible material or metal cabinets cannot be maintained, protect the underside of the cabinets above the cooktop with not less than 1/4" insulating millboard covered with sheet metal not less than 0.0122" thick. Clearance between the cooking surface and protected cabinets **MUST NEVER BE LESS THAN 24 INCHES.**
- The vertical distance from the plane of the cooking surface to the bottom of adjacent overhead cabinets extending closer than 1" to the plane of the range sides must not be less than 18". (See the *Dimensions and Clearances* illustration in this section.)
- **⚠ CAUTION** – Items of interest to children should not be stored in cabinets above a range or on the backsplash of a range—children climbing on the range to reach items could be seriously injured.

Installation Instructions

DIMENSIONS AND CLEARANCES

Provide adequate clearances between the range and adjacent combustible surfaces. These dimensions must be met for safe use of your range. The location of the electrical outlet and pipe opening (see Gas Pipe and Electric Outlet Locations) may be adjusted to meet specific requirements.

The range may be placed with 0" clearance (flush) at the back wall.

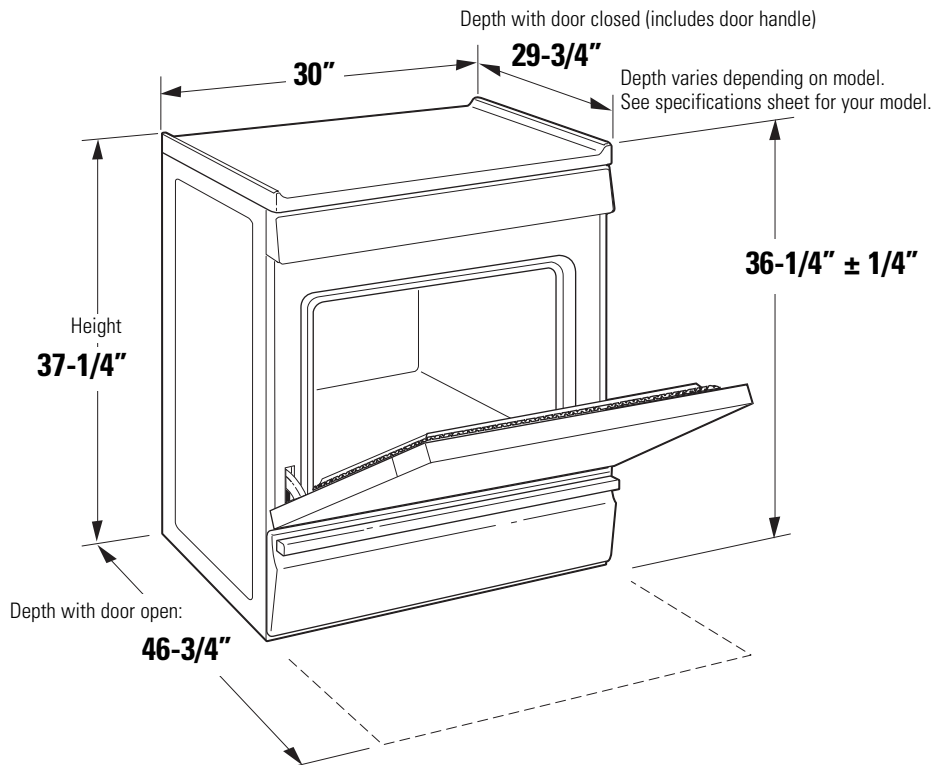
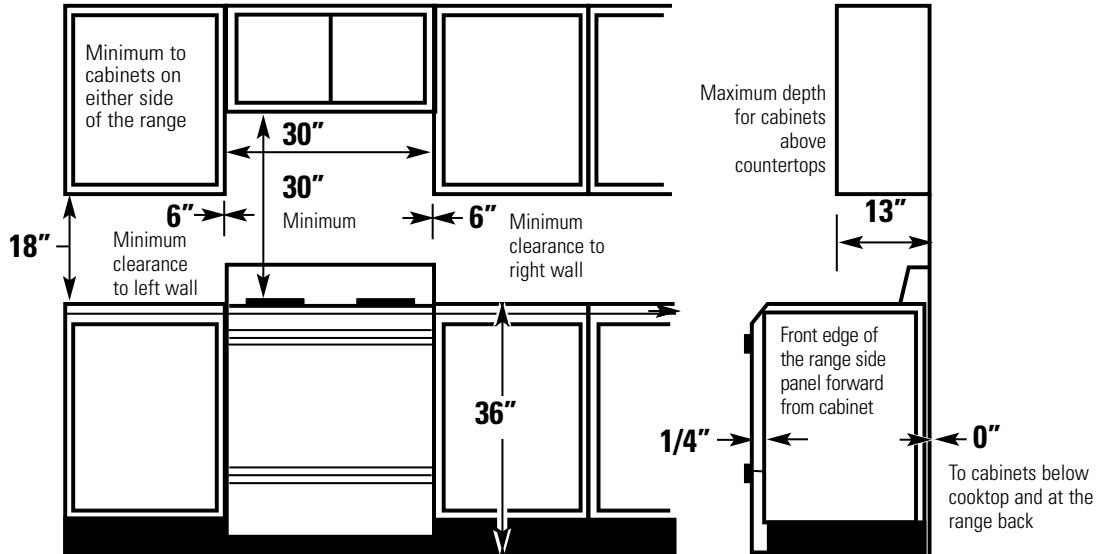

Installation Instructions

⚠ WARNING! **ANTI-TIP DEVICE**

	⚠ WARNING <ul style="list-style-type: none">• All ranges can tip.• BURNS or other SERIOUS INJURIES can result.• INSTALL and CHECK the ANTI-TIP bracket following the instructions supplied with the bracket.
---	---

To reduce the risk of tipping the range, the range must be secured by a properly installed anti-tip bracket. See installation instructions shipped with the bracket for complete details before attempting to install.

To check if the bracket is installed and engaged properly, carefully tip the range forward. The bracket should stop the range within 4 inches. If it does not, the bracket must be reinstalled. If the range is pulled from the wall for any reason, always repeat this procedure to verify the range is properly secured by the anti-tip bracket.

For free standing or slide in ranges, never completely remove the leveling legs or the range will not be secured to the anti-tip device properly.

If you did not receive an anti-tip bracket with your purchase, call 1.800.626.8774 to receive one at no cost (In Canada, call 1.800.561.3344). For installation instructions of the bracket, visit: GEAppliances.com (In Canada, GEAppliances.ca)

LOCATION

Do not locate the range where it may be subject to strong drafts. Any openings in the floor or wall behind the range should be sealed. Make sure the openings around the base of the range that supply fresh air for combustion and ventilation are not obstructed by carpeting or woodwork.

Your range, like many other household items, is heavy and can settle into soft floor coverings such as cushioned vinyl or carpeting. Use care when moving the range on this type of flooring. It is recommended that the following simple and inexpensive instructions be followed to protect your floor.

The range should be installed on a sheet of plywood (or similar material). When the floor covering ends at the front of the range, the area that the range will rest on should be built up with plywood to the same level or higher than the floor covering.

This will allow the range to be moved for cleaning or servicing. Also, make sure your floor covering will withstand 180°F. (See the *Installation Safety Instructions* section.)

Make sure the wall coverings around your range can withstand the heat generated (up to 200°F) by the range. (See the *Installation Safety Instructions* section.)

IMPORTANT!

Remove all tape and packaging. Make sure the burners are properly seated and level.

Take the accessory pack out of the oven and/or drawer.

Check to be sure that no range parts have come loose during shipping.

Installation Instructions

1 PROVIDE ADEQUATE GAS SUPPLY

Your range is designed to operate at a pressure of 5" of water column on natural gas or, if designed for LP gas (propane or butane), 10" of water column.

Make sure you are supplying your range with the type of gas for which it is designed.

This range is convertible for use on natural or propane gas. If you decide to use this range on LP gas, conversion must be made by a qualified LP installer before attempting to operate the range on that gas.

For proper operation, the pressure of natural gas supplied to the regulator must be between 5" and 13" of water column.

For LP gas, the pressure supplied must be between 10" and 13" of water column.

When checking for proper operation of the regulator, the inlet pressure must be at least 1" greater than the operating (manifold) pressure as given above.

The pressure regulator located at the inlet of the range manifold must remain in the supply line regardless of whether natural or LP gas is being used.

A flexible metal appliance connector used to connect the range to the gas supply line should have an I.D. of 1/2" and be 5 feet in length for ease of installation. In Canada, flexible connectors must be single wall metal connectors no longer than 6 feet in length.

2 CONNECT THE RANGE TO GAS

Shut off the main gas supply valve before disconnecting the old range and leave it off until the new hook-up has been completed. Don't forget to relight the pilot on other gas appliances when you turn the gas back on.

Because hard piping restricts movement of the range, the use of a CSA International-certified flexible metal appliance connector is recommended unless local codes require a hard-piped connection.

Never use an old connector when installing a new range. If the hard piping method is used, you must carefully align the pipe; the range cannot be moved after the connection is made.

To prevent gas leaks, put pipe joint compound on, or wrap pipe thread tape with Teflon* around, all male (external) pipe threads.

A. Install a manual gas line shut-off valve in the gas line in an easily accessed location outside of the range. Make sure everyone operating the range knows where and how to shut off the gas supply to the range.

B. Install male 1/2" flare union adapter to the 1/2" NPT internal thread at inlet of regulator. Use a backup wrench on the regulator fitting to avoid damage.

When installing the range from the front, remove the 90° elbow for easier installation.

C. Install male 1/2" or 3/4" flare union adapter to the NPT internal thread of the manual shut-off valve, taking care to back-up the shut-off valve to keep it from turning.

D. Connect flexible metal appliance connector to the adapter on the range. Position range to permit connection at the shut-off valve.

E. When all connections have been made, make sure all range controls are in the off position and turn on the main gas supply valve. Use a liquid leak detector at all joints and connections to check for leaks in the system.

⚠ WARNING: DO NOT USE A FLAME TO CHECK FOR GAS LEAKS.

When using test pressures greater than 1/2 psig to pressure test the gas supply system of the residence, disconnect the range and individual shut-off valve from the gas supply piping. When using test pressures of 1/2 psig or less to test the gas supply system, simply isolate the range from the gas supply system by closing the individual shut-off valve.

*Teflon: Registered trademark of DuPont

Installation Instructions

GAS PIPE AND ELECTRICAL OUTLET LOCATIONS

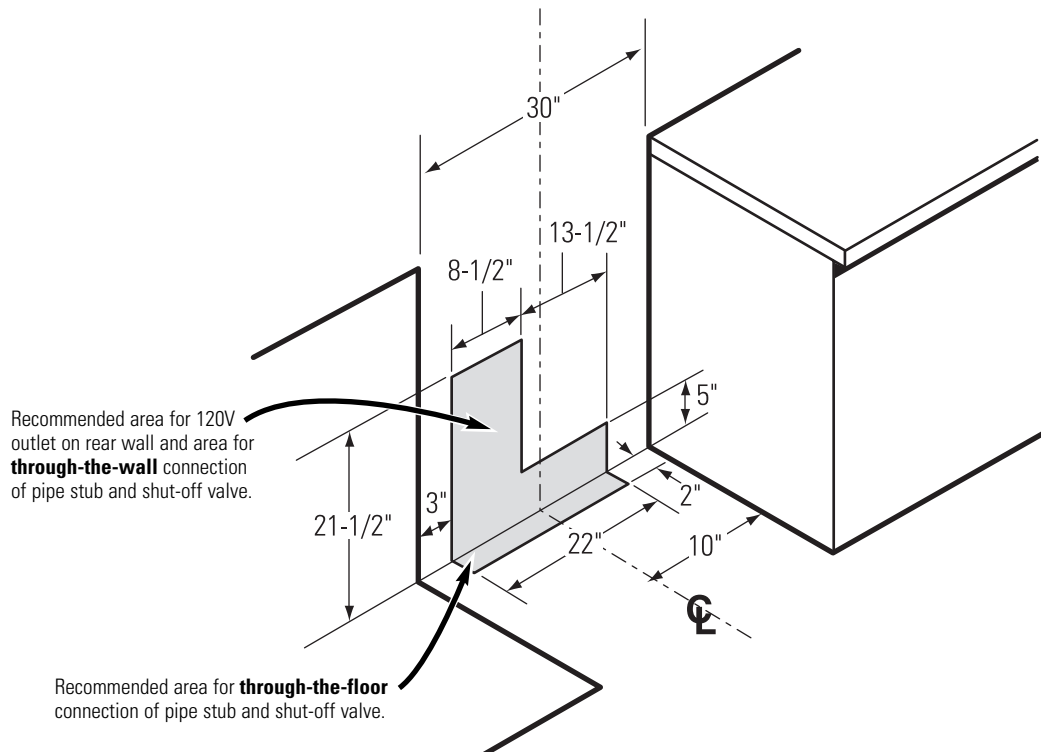

Installation Instructions

FLEXIBLE CONNECTOR HOOKUP

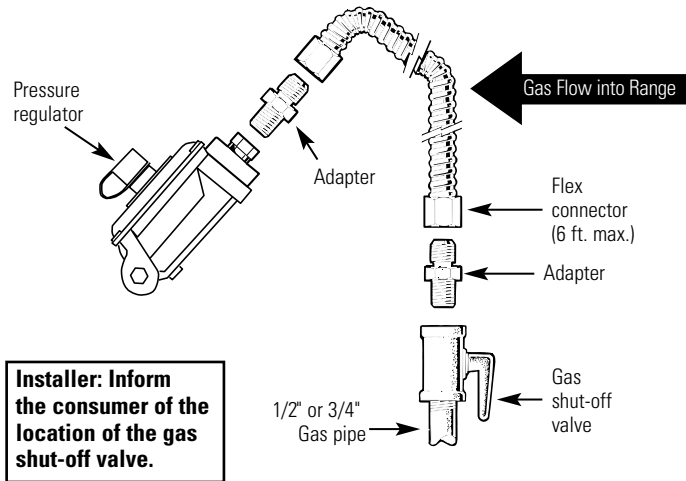

RIGID PIPE HOOKUP OPTIONS

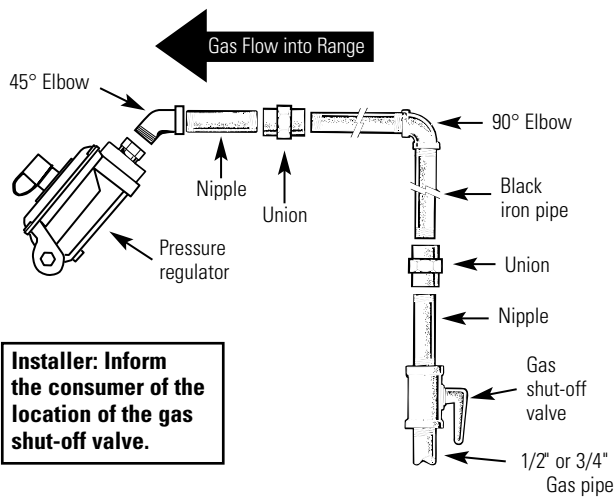

Alternate Hookup

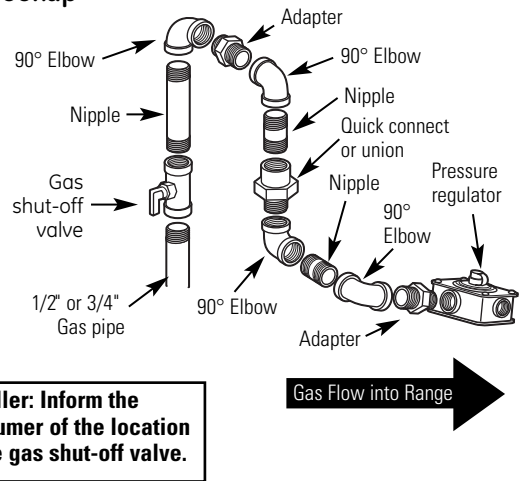

Installation Instructions

3 ELECTRICAL CONNECTIONS

Electrical Requirements

120-volt, 60 Hertz, properly grounded dedicated circuit protected by a 15-amp or 20-amp circuit breaker or time delay fuse.

Extension Cord Cautions

Because of potential safety hazards associated with certain conditions, we strongly recommend against the use of an extension cord. However, if you still elect to use an extension cord, it is absolutely necessary that it be a UL-listed, 3-wire grounding-type appliance extension cord and that the current carrying rating of the cord in amperes be equivalent to, or greater than, the circuit rating.

Grounding

IMPORTANT—(Please read carefully)

FOR PERSONAL SAFETY, THIS APPLIANCE MUST BE PROPERLY GROUNDED.

Preferred Method

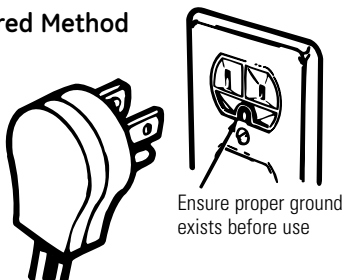

The power cord of this appliance is equipped with a three-prong (grounding) plug which mates with a standard three-prong grounding wall receptacle to minimize the possibility of electric shock hazard from this appliance.

The customer should have the wall receptacle and circuit checked by a qualified electrician to make sure the receptacle is properly grounded.

Where a standard two-prong wall receptacle is encountered, it is the personal responsibility and obligation of the customer to have it replaced with a properly grounded three-prong wall receptacle.

DO NOT, UNDER ANY CIRCUMSTANCES, CUT OR REMOVE THE THIRD (GROUND) PRONG FROM THE POWER CORD.

A word about GFCI's – GFCI's are not required or recommended for gas range receptacles.

Ground Fault Circuit Interrupters (GFCI's) are devices that sense leakage of current in a circuit and automatically switch off power when a threshold leakage level is detected. These devices must be manually reset by the consumer. The National Electrical Code requires the use of GFCI's in kitchen receptacles installed to serve countertop surfaces. Performance of the range will not be affected if operated on a GFCI-protected circuit but occasional nuisance tripping of the GFCI breaker is possible.

3 ELECTRICAL CONNECTIONS (CONT.)

A. Usage Situations where Appliance Power Cord will be Disconnected Infrequently.

An adapter may be used only on a 15-amp circuit. Do not use an adapter on a 20-amp circuit. Where local codes permit, a **TEMPORARY CONNECTION** may be made to a properly grounded two-prong wall receptacle by the use of a UL-listed adapter, available at most hardware stores. The larger slot in the adapter must be aligned with the larger slot in the wall receptacle to provide proper polarity in the connection of the power cord.

Temporary Method

(Adapter plugs not permitted in Canada)

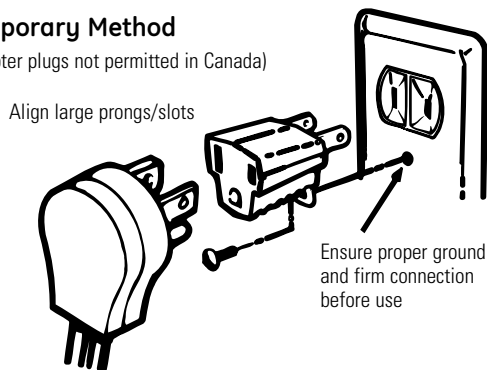

CAUTION: Attaching the adapter ground terminal to the wall receptacle cover screw does not ground the appliance unless the cover screw is metal, and not insulated, and the wall receptacle is grounded through the house wiring. The customer should have the circuit checked by a qualified electrician to make sure the receptacle is properly grounded.

When disconnecting the power cord from the adapter, always hold the adapter with one hand. If this is not done, the adapter ground terminal is very likely to break with repeated use. Should this happen, **DO NOT USE** the appliance until a proper ground has again been established.

Installation Instructions

3 ELECTRICAL CONNECTIONS (CONT.)

B. Usage Situations where Appliance Power Cord will be Disconnected Frequently.

Do not use an adapter plug in these situations because disconnecting of the power cord places undue strain on the adapter and leads to eventual failure of the adapter ground terminal. The customer should have the two-prong wall receptacle replaced with a three-prong (grounding) receptacle by a qualified electrician before using the appliance.

The installation of appliances designed for mobile home installation must conform with the Manufactured Home Construction and Safety Standard, Title 24 CFR, Part 3280 (formerly the Federal Standard for Mobile Home Construction and Safety, Title 24, HUD, Part 280) or, when such standard is not applicable, the Standard for Manufactured Home Installations, latest edition (Manufactured Home Sites, Communities and Set-Ups), ANSI A225.1, latest edition, or with local codes. In Canada, mobile home installation must be in accordance with the current CAN/CSA Z240/MH Mobile Home Installation Code.

Electric Disconnect

- Locate disconnect plug on the range back.
- Pinch sides of connector and pull out of range back.

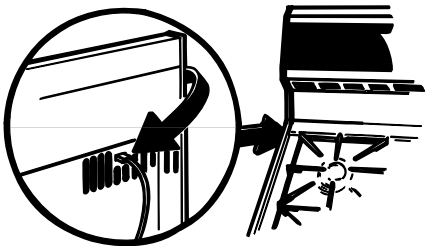

4 SEAL THE OPENINGS

Seal any openings in the wall behind the range and in the floor under the range when hookups are completed.

5 ASSEMBLE SURFACE BURNERS

A Burner Heads

Place burner heads over the electrodes on the cooktop, in the correct locations according to their size. There is one small, one medium, one extra large and one dual flame extra large burner head.

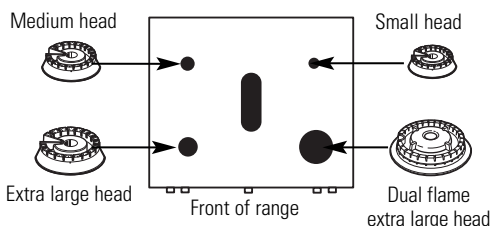

5 ASSEMBLE SURFACE BURNERS (CONT.)

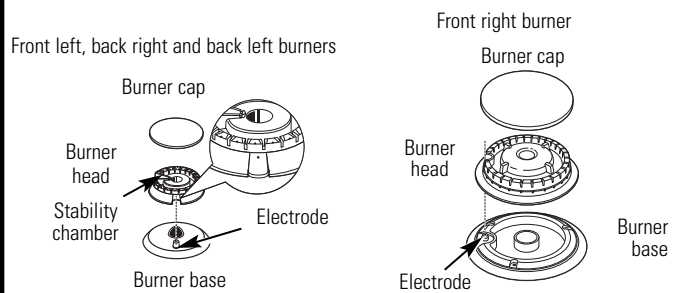

Make sure the slot in the burner head is positioned over the electrode.

Make sure the hole in the burner head assembly is positioned over the electrode and that the burner head is fully inserted inside the burner base. A small gap between the base and head is normal.

B Oval (Center) Burner Head/Cap Assembly

Place the oval (center) head/cap assembly over the electrode on the cooktop.

Oval head and cap assembly

Make sure the slot in the burner head is positioned over the electrode.

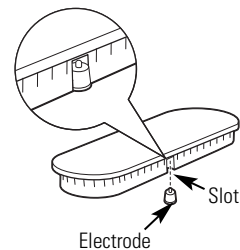
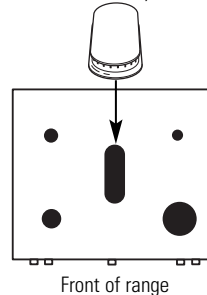

C Caps

Place the matching size caps onto the burner bases or heads.

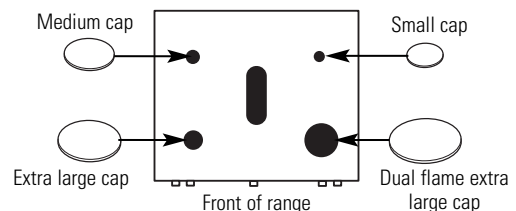

Make sure that the heads and caps are replaced in the correct locations.

D Grates

Place the side and center grates on the cooktop. These grates are position specific. The undersides of the side grates are marked "OUTSIDE." The center grate can be interchanged front to back.

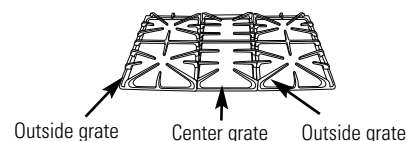

CAUTION: Do not operate the burner without all burner parts in place.

Installation Instructions

6 CHECK IGNITION OF SURFACE BURNERS

Operation of all cooktop and oven burners should be checked after the range and gas supply lines have been carefully checked for leaks.

Electric Ignition Models

Select a top burner knob and simultaneously push in and turn to **LITE** position. You will hear a **clicking** sound indicating proper operation of the spark module. Once the air has been purged from the supply lines, burners should light within 4 seconds. After burner lights, rotate knob out of the **LITE** position. Try each burner in succession until all burners have been checked.

Quality of Flames

The combustion quality of burner flames needs to be determined visually.



(A) Yellow flames—
Call for service



(B) Yellow tips on
outer cones—
Normal for LP gas



(C) Soft blue
flames—Normal
for natural gas

If burner flames look like (A), call for service. Normal burner flames should look like (B) or (C), depending on the type of gas you use.

With LP gas, some yellow tipping on outer cones is normal.

7 CHECK IGNITION OF OVEN BURNER

The oven is designed to operate quietly and automatically. To operate the oven, press the **BAKE** pad and then press the number pads until **350°** appears in the display. Touch the **START** pad. After 30-90 seconds, the oven burner will ignite and burn until the set temperature is reached. The oven burner will continue to cycle on and off as necessary to maintain the oven at the temperature indicated by the display.

To check ignition of the broil burner, touch the **BROIL HI/LO** pad and then the **START** pad. After 30-90 seconds, the broil burner will ignite.

Electric ignition models require electrical power to operate. In case of a power outage, the oven burners on these models cannot be lit manually with a match. Gas will not flow unless the glow bar is hot.

If the oven is in use when a power outage occurs, the burner will shut off and cannot be re-lit until power is restored.

Installation Instructions

8 ADJUST BROIL AND OVEN BURNER AIR ADJUSTMENT SHUTTERS IF NECESSARY

Air adjustment shutters for the top and bottom burners regulate the flow of air to the flames.

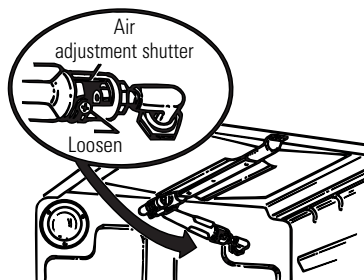

The air adjustment shutter for the top (broil) burner is in the center of the rear wall of the oven.

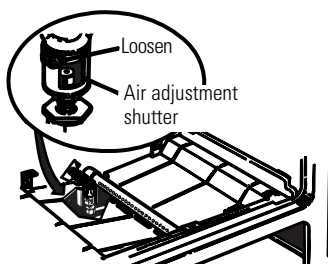

The shutter for the bottom (oven) burner is near the back wall behind the drawer. Remove the drawer. See the *Care and cleaning of the range* section.

To adjust the flow of air to either burner, loosen the Phillips head screw and rotate the shutter toward open or closed position as needed.

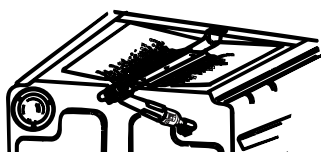

The flames for the top (broil) burner should be steady with approximately 1 blue cones and should not extend out over the edges of the burner baffle.

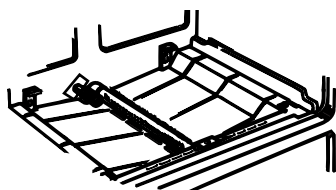

To determine if the bottom burner flames are burning properly, remove the oven bottom. Flames should have approximately 1 blue cones and, if range is supplied with natural gas, should burn with no yellow tipping. (With most LP gas, small yellow tips at the end of outer cones are normal.) Flames should not lift off burner ports. If lifting is observed, gradually reduce air shutter opening until flames are stabilized.

8 ADJUST BROIL AND OVEN BURNER AIR ADJUSTMENT SHUTTERS IF NECESSARY (CONT.)

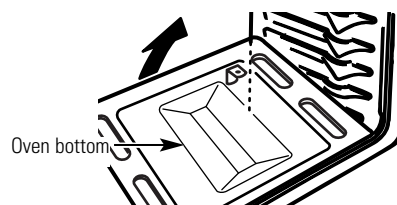

To remove the oven bottom:

- Remove the screws holding down rear of the oven bottom.
- Grasp the oven bottom at finger slots on each side.
- Lift the rear of the oven bottom enough to clear the lip of the range frame, push it back, and then pull it up and out.

9 LEVELING THE RANGE

- Install the oven racks in the oven and position the range where it will be installed.

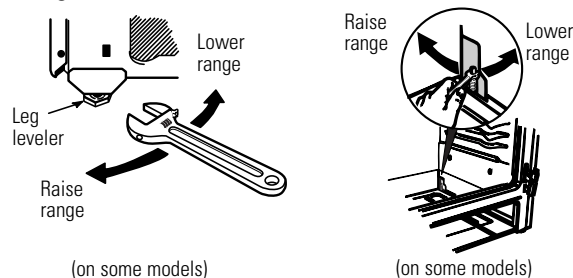

- Check for levelness by placing a spirit level or a cup, partially filled with water, on one of the oven racks. If using a spirit level, take two readings—with the level placed diagonally first in one direction and then the other.
- Remove the drawer. See the *Care and cleaning of the range* section. The front leveling legs can be adjusted from the bottom and the rear legs can be adjusted from the top or the bottom.
- Use an open-end or adjustable wrench to adjust the leveling legs until the range is level.
- After the range is level, slide the range away from the wall so that the Anti-Tip device can be installed.

Installation Instructions

10 INSTALLING THE ANTI-TIP DEVICE

⚠ WARNING!

- Range must be secured with an approved Anti-Tip device.
- Unless properly installed, the range could be tipped by you or a child standing, sitting or leaning on an open door.
- After installing the Anti-Tip device, verify that it is in place by carefully attempting to tilt the range forward.
- This range has been designed to meet all recognized industry tip standards for all normal conditions.
- The use of this device does not preclude tipping of the range when not properly installed.
- If the Anti-Tip Device supplied with the range does not fit this application, use the Anti-Tip Device WB02K10254.

- A. Mark the wall where the **RIGHT EDGE** of the range is to be located. Be sure to allow for the countertop overhang if you intend to install the range next to cabinets.

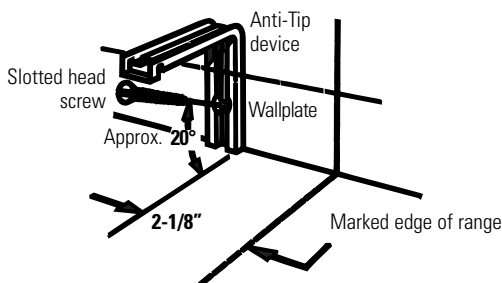

- B. Locate the outside edge of the device $2\frac{1}{8}$ " toward the center of the range from the marked edge of the range.
- C. Using the device as a template, mark the position of the hole for the screw.
- D. For wood construction, drill a pilot hole at an angle of 20 degrees from the horizontal. A nail or awl may be used if a drill is not available.

Mount the Anti-Tip device with the screw provided.

For cement or concrete construction, you will need a $\frac{1}{4}$ " x $1\frac{1}{2}$ " lag bolt and a $\frac{1}{2}$ " O.D. sleeve anchor, which are not provided. Drill the recommended size hole for the hardware.

10 INSTALLING THE ANTI-TIP DEVICE (CONT.)

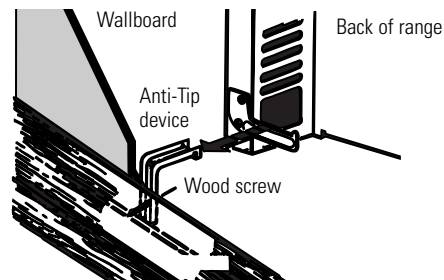

Install the sleeve anchor into the drilled hole and then install the lag bolt through the device. The bolts must be properly tightened as recommended for the hardware.

- E. Slide the range against the wall, and check for proper installation by grasping the front edge of the cooktop and carefully attempting to tilt the range forward. The bracket should stop the range within 4 inches. If it does not, the bracket must be reinstalled.

WHEN ALL HOOKUPS ARE COMPLETED

Make sure all controls are left in the off position. Make sure the flow of combustion and ventilation air to the range is unobstructed.

CONVERTING TO LP GAS (or converting back to natural gas from LP)

This range leaves the factory set for use with natural gas. If you want to convert to LP gas, the conversion must be performed by a qualified LP gas installer.

The conversion instructions and LP orifices can be found attached to the range next to the pressure regulator.

Keep these instructions and the orifices in case you want to convert back to natural gas.



Troubleshooting Tips
 Save time and money! Review the charts on the following pages first and you may not need to call for service.

Problem	Possible Causes	What To Do
Top burners do not light or do not burn evenly. (The front right burner is designed to have slightly smaller flames between the 6 and 9 o'clock positions. This is normal.)	Plug on range is not completely inserted in the electrical outlet.	<ul style="list-style-type: none"> Make sure electrical plug is plugged into a live, properly grounded outlet.
	Burner slits on the side of the burner may be clogged.	<ul style="list-style-type: none"> Remove the burners and clean them. Check the electrode area for burned-on food or grease. See the <i>Care and cleaning of the range</i> section.
	Improper burner assembly.	<ul style="list-style-type: none"> Make sure the burner parts are installed correctly. See the <i>Care and cleaning of the range</i> section.
Burner flames very large or yellow	Improper air to gas ratio.	<ul style="list-style-type: none"> If range is connected to LP gas, contact the person who installed your range or made the conversion.
Surface burners light but oven does not	The oven gas shut-off valve may have accidentally been moved during cleaning or moving.	<ul style="list-style-type: none"> To check the oven gas shut-off valve, remove the drawer (see the <i>Care and cleaning of the range</i> section). Remove the rear access panel by unscrewing the thumb screws in the upper left and right corners. Look for the gas shut-off lever at the back of the range.
Control signals after entering cooking time or start time	You forgot to enter a bake temperature or cleaning time.	<ul style="list-style-type: none"> Touch the BAKE pad and desired temperature or the SELF CLEAN pad and desired clean time.
Food does not bake or roast properly in the upper oven	Oven controls improperly set.	<ul style="list-style-type: none"> See the <i>Using the upper oven</i> section.
	Rack position is incorrect.	<ul style="list-style-type: none"> See the <i>Using the upper oven</i> section.
	Incorrect cookware or cookware of improper size being used.	<ul style="list-style-type: none"> See the <i>Using the upper oven</i> section.
	Oven thermostat needs adjustment.	<ul style="list-style-type: none"> See the <i>Adjust the upper oven thermostat—Do it yourself!</i> section.
	Clock not set correctly.	<ul style="list-style-type: none"> See the <i>Using the clock and timer</i> section.
	Aluminum foil used improperly in the oven.	<ul style="list-style-type: none"> See the <i>Care and cleaning of the range</i> section.
	Oven bottom not securely seated in position.	<ul style="list-style-type: none"> See the <i>Installation of the range</i> section.
Burners do not light	Gas/Control Lockout feature is activated.	<ul style="list-style-type: none"> Allow the range to cool down and touch and hold the GAS/CONTROL LOCKOUT pad (on some models) for 3 seconds until LOC disappears from the display.
	Plug on range is not completely inserted in the electrical outlet.	<ul style="list-style-type: none"> Make sure electrical plug is plugged into a live, properly grounded outlet.
	Gas supply not connected or turned on.	<ul style="list-style-type: none"> See the Installation Instructions that came with your range.
	A fuse in your home may be blown or circuit breaker tripped.	<ul style="list-style-type: none"> Replace the fuse or reset the circuit breaker.
	Burner parts not replaced correctly.	<ul style="list-style-type: none"> See the <i>Care and cleaning of the range</i> section.

Before you call for service...



Troubleshooting Tips

Problem	Possible Causes	What To Do
<i>Gas/Control Lockout or Control Lockout feature is activated</i>		<ul style="list-style-type: none"> If LOC appears in the display, the range control is locked. Turn this feature off to use the range. See the <i>Gas/Control Lockout</i> section.
<i>"Close Door" scrolls in the display when BROIL is set</i>	The display will always automatically remind you to close the door.	<ul style="list-style-type: none"> This is a normal reminder to close the door when broiling.
<i>Food does not broil properly in the upper oven</i>	Oven controls improperly set.	<ul style="list-style-type: none"> Make sure you touch the BROIL HI/LO pad.
	Oven door not closed.	<ul style="list-style-type: none"> See the <i>Using the upper oven</i> section.
	Improper rack position being used.	<ul style="list-style-type: none"> See the <i>Broiling Guide</i>.
	Food being cooked in a hot pan.	<ul style="list-style-type: none"> For best results, use a pan designed for broiling. Make sure it is cool.
	Cookware not suited for broiling.	<ul style="list-style-type: none"> For best results, use a pan designed for broiling.
<i>Upper oven temperature too hot or too cold</i>	Oven thermostat needs adjustment.	<ul style="list-style-type: none"> See the <i>Adjust the upper oven thermostat—Do it yourself!</i> section.
<i>Clock and timer do not work</i>	Plug on range is not completely inserted in the electrical outlet.	<ul style="list-style-type: none"> Make sure electrical plug is plugged into a live, properly grounded outlet.
	A fuse in your home may be blown or the circuit breaker tripped.	<ul style="list-style-type: none"> Replace the fuse or reset the circuit breaker.
	Oven controls improperly set.	<ul style="list-style-type: none"> See the <i>Using the clock and timer</i> section.
<i>Upper oven light does not work</i>	Light bulb is loose or defective.	<ul style="list-style-type: none"> Tighten or replace the bulb.
	Plug on range is not completely inserted in the electrical outlet.	<ul style="list-style-type: none"> Make sure electrical plug is plugged into a live, properly grounded outlet.
<i>Upper oven will not self-clean</i>	The oven temperature is too high to set a self-clean operation.	<ul style="list-style-type: none"> Allow the range to cool to room temperature and reset the controls.
	Oven controls improperly set.	<ul style="list-style-type: none"> See the <i>Using the self-cleaning upper oven</i> section.
<i>"Crackling" or "popping" sound</i>	This is the sound of the metal heating and cooling during both the cooking and cleaning functions.	<ul style="list-style-type: none"> This is normal.

Problem	Possible Causes	What To Do
Excessive smoking	Excessive soil.	<ul style="list-style-type: none"> • Touch the CLEAR/OFF pad. Open the windows to rid the room of smoke. Wait until the LOCKED DOOR light goes off. Wipe up the excess soil and reset the clean cycle.
Oven door will not open after a clean cycle	Oven too hot.	<ul style="list-style-type: none"> • Allow the oven to cool below locking temperature.
Oven not clean after a clean cycle	Oven controls not properly set.	<ul style="list-style-type: none"> • See the <i>Using the self-cleaning upper oven</i> section.
	Oven was heavily soiled.	<ul style="list-style-type: none"> • Clean up heavy spillovers before starting the clean cycle. Heavily soiled ovens may need to self-clean again or for a longer period of time.
"LOCK DOOR" flashes in the display	The self-clean cycle has been selected but the door is not closed.	<ul style="list-style-type: none"> • Close the oven door.
LOCKED DOOR light is on when you want to cook	The oven door is locked because the temperature inside the oven has not dropped below the locking temperature.	<ul style="list-style-type: none"> • Touch the CLEAR/OFF pad. Allow the oven to cool.
"F—and a number or letter" flash in the display	You have a function error code.	<ul style="list-style-type: none"> • Touch the CLEAR/OFF pad. Allow the oven to cool for one hour. Put the oven back into operation.
	If the function code repeats.	<ul style="list-style-type: none"> • Disconnect all power to the range for 5 minutes and then reconnect power. If the function error code repeats, call for service.
Oven racks are difficult to slide	The gray porcelain-coated racks were improperly cleaned.	<ul style="list-style-type: none"> • Apply a small amount of vegetable oil to a paper towel and wipe the edges of the oven racks with the paper towel. Do not spray with Pam® or other lubricant sprays.
"Probe" appears in the display	This is reminding you to enter a probe temperature after plugging in the probe.	<ul style="list-style-type: none"> • Enter a probe temperature.
LOC appears in the display	The Gas/Control Lockout feature is activated.	<ul style="list-style-type: none"> • Be sure the surface burner controls are turned OFF. Turn this feature off to use the range. See the <i>Gas/Control Lockout</i> section.

Safety Instructions

Operating Instructions

Installation Instructions

Troubleshooting Tips

Consumer Support

Before you call for service...



Troubleshooting Tips

Problem	Possible Causes	What To Do
Display goes blank	A fuse in your home may be blown or the circuit breaker tripped.	<ul style="list-style-type: none"> Replace the fuse or reset the circuit breaker.
	The clock is in the black-out mode.	<ul style="list-style-type: none"> See the <i>Special features of your oven control</i> section.
Display flashes	Power failure.	<ul style="list-style-type: none"> Reset the clock.
Unable to get the display to show "SF"	Oven control pads were not pressed properly.	<ul style="list-style-type: none"> The BAKE and BROIL HI/LO pads must be touched at the same time and held for 3 seconds.
Power outage, clock flashes	Power outage or surge.	<ul style="list-style-type: none"> Reset the clock. If the oven was in use, you must reset it by touching the CLEAR/OFF pad, setting the clock and resetting any cooking function.
"Burning" or "oily" odor emitting from the vent	This is normal in a new oven and will disappear in time.	<ul style="list-style-type: none"> To speed the process, set a self-clean cycle for a minimum of 3 hours. See the <i>Using the self-cleaning oven</i> section.
Strong odor	An odor from the insulation around the inside of the oven is normal for the first few times the oven is used.	<ul style="list-style-type: none"> This is temporary.
Fan noise	The convection fan may turn on and off automatically.	<ul style="list-style-type: none"> This is normal. To maximize cooking evenness, the fan is designed to operate in both directions with a pause in between.
Convection fan not working	Preheat temperature not reached.	<ul style="list-style-type: none"> Fan will start automatically once the preheat temperature is reached.
Drawer does not slide smoothly or drags	The drawer is out of alignment.	<ul style="list-style-type: none"> Fully extend the drawer and push it all the way in. See the <i>Care and cleaning of the range</i> section.
	Drawer is over-loaded or load is unbalanced.	<ul style="list-style-type: none"> Reduce weight. Redistribute drawer contents.
Lower oven drawer will not work	A fuse in your home may be blown or the circuit breaker tripped.	<ul style="list-style-type: none"> Replace the fuse or reset the circuit breaker.
	The oven is self-cleaning.	<ul style="list-style-type: none"> Wait for the self-clean cycle to finish and the oven to cool.
	Controls improperly set.	<ul style="list-style-type: none"> See the <i>Lower oven drawer</i> section.
Excessive condensation in the drawer	Liquid in drawer.	<ul style="list-style-type: none"> Remove liquid.
	Uncovered foods.	<ul style="list-style-type: none"> Cover food with lid or aluminum foil.
	Temperature setting too high.	<ul style="list-style-type: none"> Reduce temperature setting.
Food dries out in the lower oven drawer	Moisture escaping.	<ul style="list-style-type: none"> Cover food with lid or aluminum foil.
	Drawer not fully closed.	<ul style="list-style-type: none"> Push drawer in until latch engages.

Please place in envelope and mail to:
Veuillez mettre dans une enveloppe et envoyez à :

**OWNERSHIP REGISTRATION
P.O. BOX 1780
MISSISSAUGA, ONTARIO
L4Y 4G1**

(FOR CANADIAN CONSUMERS ONLY)



For Canadian
Customers



Pour les
Consommateurs
Canadiens

CUT ALONG THIS LINE AND RETURN CARD—THANKS

OWNERSHIP REGISTRATION CERTIFICATE – FICHE D'INSCRIPTION DU PROPRIÉTAIRE			
Please register your product to enable us to contact you in the remote event a safety notice is issued for this product and to allow for efficient communication under the terms of your warranty, should the need arise.		Veuillez enregistrer votre produit afin de nous permettre de communiquer avec vous si jamais un avis de sécurité concernant ce produit était émis et de communiquer facilement avec vous en vertu de votre garantie, si le besoin s'en fait sentir.	
REGISTER ON-LINE:	www.geappliances.ca	MAIL TO:	P.O. BOX 1780, MISSISSAUGA
ENREGISTREMENT SUR INTERNET À:	www.electromenagersqe.ca	POSTER À:	ONTARIO, L4Y 4G1
<input type="checkbox"/> MR./M <input type="checkbox"/> MISS/MLE.	<input type="checkbox"/> MRS./MME. <input type="checkbox"/> MS.	FIRST NAME / PRÉNOM	LAST NAME / NOM
STREET NO / N° RUE	STREET NAME / RUE	APT. NO / APP. / RR#	
CITY / VILLE		PROVINCE	POSTAL CODE / POSTAL
AREA CODE / IND. RÉG.	TELEPHONE	E-MAIL	
DID YOU PURCHASE A SERVICE CONTRACT FOR THIS APPLIANCE? AVEZ-VOUS ACHETÉ UN CONTRAT DE SERVICE POUR CET APPAREIL ?		YES / OUI <input type="checkbox"/> NO / NON <input type="checkbox"/>	IF YES / SI OUI: EXPIRATION Y/A M D/J
NAME OF SELLING DEALER / NOM DU MARCHAND		MODEL / MODÈLE	
INSTALLATION DATE / DATE D'INSTALLATION Y/A M D/J	CORRESPONDENCE CORRESPONDANCE	<input type="checkbox"/> ENGLISH <input type="checkbox"/> FRANÇAIS	SERIAL / SÉRIE
<input type="checkbox"/> I do not wish to receive any promotional offers regarding this product. <input type="checkbox"/> Je ne désire pas recevoir d'offres promotionnelles concernant ce produit.			



Looking For Something More?

You can find these accessories and many more at **GEAppliances.com** (U.S.) or **www.GEAppliances.ca** (Canada), or call **800.626.2002** (U.S.) or **800.661.1616** (Canada) (during normal business hours). Have your model number ready.

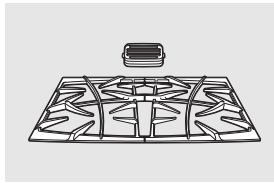

Grates

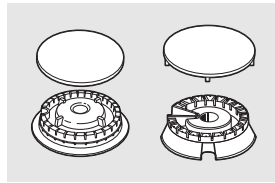

Surface Burner Heads and Caps

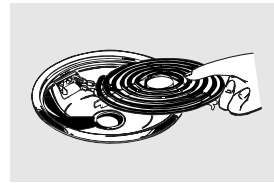

Surface Elements and Drip Pans

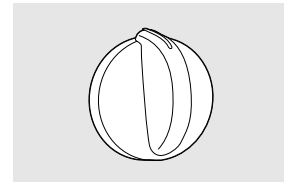

Knobs

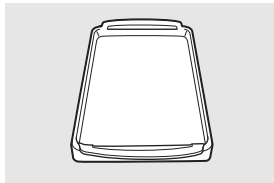

Griddle

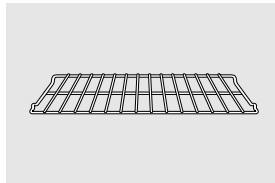

Oven Racks

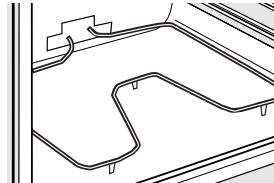

Oven Elements

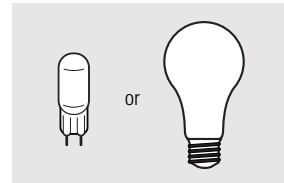

Light Bulbs

Experience these other great products to keep your kitchen looking great!



Ceramic Cooktop Cleaning Kit: Includes cleaner, scraper and pad

WX10X117GCS



Ceramic Cooktop Cleaning Wipes

WX10X305



Stainless Steel Appliance Polish Wipes

WX10X10001



Stainless Steel Appliance Cleaner

PM10X311

Get the most out of your Broiler Pan! (Not for use with Broiler Drawer models.)

Use your pan and grid cover to broil hamburgers, seafood, steaks, vegetables, bacon, chops and so much more! The pan below catches the excess fats and oils.

- Genuine GE Part
- Easy To Clean
- One-Year Warranty

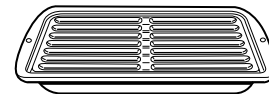

Limited Time Offer! Free Shipping!

When you order your broiler pan **within 30 days** of purchasing your GE cooking product.

	Small	Large*	XL**
U.S. Part #	WB48X10055	WB48X10056	WB48X10057
Canada Part #	222D2097G001	222D2097G002	N/A
Dimensions	8-3/4" W x 1-1/4" H x 13-1/2" D	12-3/4" W x 1-1/4" H x 16-1/2" D	17" W x 1-1/4" H x 19-1/4" D
Price	US\$10.50[†]	US\$14.50[†]	US\$16.75[†]

[†] Plus applicable state sales tax (PST/HST and GST)

* The large (standard) broil pan does not fit in 20"/24" ranges.

** The XL pan does not fit in 24" wall ovens, 27" drop-ins or 20"/24" ranges.

To place your order, call **800.626.2002** (U.S.), **800.661.1616** (Canada) or mail this form to:

In the U.S.: GE Parts, P.O. Box 221027, Memphis, TN 38122-1027. **In Canada:** GE Parts, 1 Factory Lane, Moncton, N.B. E1C 9M3



Broiler Pan Order Form

Quantity _____ Part Number _____

Model Number _____ Serial Number _____ Brand _____ Date of Purchase _____

First Name _____ Last Name _____

Address _____

City _____ State _____ Zip Code _____

Phone _____ E-Mail _____

Credit Card Check Money Order

Visa MasterCard Discover AmEx Credit Card # _____

Exp. Date: Month _____ Year _____ Signature: _____

GE Gas Range Warranty. (For customers in the United States)



All warranty service provided by our Factory Service Centers or an authorized Customer Care® technician. To schedule service, visit us on-line at GEAppliances.com, or call 800.GE.CARES (800.432.2737). Please have serial number and model number available when calling for service.

Staple your receipt here.
Proof of the original purchase date is needed to obtain service under the warranty.

For The Period Of: GE Will Replace:

One Year

From the date of the original purchase

Any part of the range which fails due to a defect in materials or workmanship. During this **limited one-year warranty**, GE will also provide, **free of charge**, all labor and in-home service to replace the defective part.

What GE Will Not Cover:

- Service trips to your home to teach you how to use the product.
- Improper installation, delivery or maintenance.
- Failure of the product if it is abused, misused, or used for other than the intended purpose or used commercially.
- Replacement of house fuses or resetting of circuit breakers.
- Damage to the product caused by accident, fire, floods or acts of God.
- Incidental or consequential damage caused by possible defects with this appliance.
- Damage caused after delivery.
- Product not accessible to provide required service.

EXCLUSION OF IMPLIED WARRANTIES—Your sole and exclusive remedy is product repair as provided in this Limited Warranty. Any implied warranties, including the implied warranties of merchantability or fitness for a particular purpose, are limited to one year or the shortest period allowed by law.

This warranty is extended to the original purchaser and any succeeding owner for products purchased for home use within the USA. If the product is located in an area where service by a GE Authorized Servicer is not available, you may be responsible for a trip charge or you may be required to bring the product to an Authorized GE Service Location for service. In Alaska, the warranty excludes the cost of shipping or service calls to your home.

Some states do not allow the exclusion or limitation of incidental or consequential damages. This warranty gives you specific legal rights, and you may also have other rights which vary from state to state. To know what your legal rights are, consult your local or state consumer affairs office or your state's Attorney General.

Warrantor: General Electric Company. Louisville, KY 40225

GE Gas Range Warranty. (For customers in Canada)



All warranty service provided by our Factory Service Centres or an authorized Customer Care® technician. To schedule service, visit us on-line at www.geappliances.ca, or call 1.800.561.3344. Please have serial number and model number available when calling for service.

Staple your receipt here. Proof of the original purchase date is needed to obtain service under the warranty.

For The Period Of: **Mabe Will Replace:**

One Year
From the date of the original purchase

Any part of the range which fails due to a defect in materials or workmanship. During this **limited one-year warranty**, Mabe will also provide, **free of charge**, all labor and in-home service to replace the defective part.

What Mabe Will Not Cover:

- Service trips to your home to teach you how to use the product.
- Improper installation, delivery or maintenance.
- Failure of the product if it is abused, misused, or used for other than the intended purpose or used commercially.
- Replacement of house fuses or resetting of circuit breakers.
- Damage to the product caused by accident, fire, floods or acts of God.
- Incidental or consequential damage caused by possible defects with this appliance.
- Damage caused after delivery.
- Product not accessible to provide required service.

EXCLUSION OF IMPLIED WARRANTIES—Your sole and exclusive remedy is product repair as provided in this Limited Warranty. Any implied warranties, including the implied warranties of merchantability or fitness for a particular purpose, are limited to one year or the shortest period allowed by law.

This warranty is extended to the original purchaser and any succeeding owner for products purchased in Canada for home use within Canada. In-home warranty service will be provided in areas where it is available and deemed reasonable by Mabe to provide.

Some provinces do not allow the exclusion or limitation of incidental or consequential damages, so the above exclusion may not apply to you. This warranty gives you specific legal rights, and you may also have other rights which vary from province to province. To know what your legal rights are in your province, consult your local or provincial consumer affairs office.

**Warrantor: Mabe Canada Inc.,
Burlington, Ontario**

Safety Instructions

Operating Instructions

Installation Instructions

Troubleshooting Tips

Consumer Support

Consumer Support.



GE Appliances Website

In the U.S.: **GEAppliances.com**

Have a question or need assistance with your appliance? Try the GE Appliances Website any day of the year! For greater convenience and faster service, you can now download Owner's Manuals, order parts or even schedule service on-line. **In Canada: www.GEAppliances.ca**



Schedule Service

In the U.S.: **GEAppliances.com**

Expert GE repair service is only one step away from your door. Get on-line and schedule your service at your convenience any day of the year! Or call 800.GE.CARES (800.432.2737) during normal business hours.

In Canada, call 1.800.561.3344

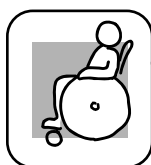

Real Life Design Studio

In the U.S.: **GEAppliances.com**

GE supports the Universal Design concept—products, services and environments that can be used by people of all ages, sizes and capabilities. We recognize the need to design for a wide range of physical and mental abilities and impairments. For details of GE's Universal Design applications, including kitchen design ideas for people with disabilities, check out our Website today. For the hearing impaired, please call 800.TDD.GEAC (800.833.4322).

In Canada, contact: Manager, Consumer Relations, Mabe Canada Inc.
Suite 310, 1 Factory Lane
Moncton, N.B. E1C 9M3



Extended Warranties

In the U.S.: **GEAppliances.com**

Purchase a GE extended warranty and learn about special discounts that are available while your warranty is still in effect. You can purchase it on-line anytime, or call 800.626.2224 during normal business hours. GE Consumer Home Services will still be there after your warranty expires. **In Canada, call 1.888.261.2133**

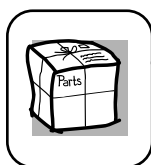

Parts and Accessories

In the U.S.: **GEAppliances.com**

Individuals qualified to service their own appliances can have parts or accessories sent directly to their homes (VISA, MasterCard and Discover cards are accepted). Order on-line today, 24 hours every day or by phone at 800.626.2002 during normal business hours.

Instructions contained in this manual cover procedures to be performed by any user. Other servicing generally should be referred to qualified service personnel. Caution must be exercised, since improper servicing may cause unsafe operation.

Customers **in Canada** should consult the yellow pages for the nearest Mabe service center, or call 1.800.661.1616.

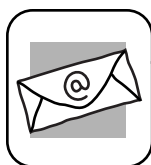

Contact Us

In the U.S.: **GEAppliances.com**

If you are not satisfied with the service you receive from GE, contact us on our Website with all the details including your phone number, or write to:

General Manager, Customer Relations
GE Appliances, Appliance Park
Louisville, KY 40225

In Canada: www.GEAppliances.ca, or write to: Director, Consumer Relations, Mabe Canada Inc.
Suite 310, 1 Factory Lane
Moncton, N.B. E1C 9M3



Register Your Appliance

In the U.S.: **GEAppliances.com**

Register your new appliance on-line—at your convenience! Timely product registration will allow for enhanced communication and prompt service under the terms of your warranty, should the need arise. You may also mail in the pre-printed registration card included in the packing material. **In Canada: www.GEAppliances.ca**