

# 20" and 24" Compact Electric Ranges

**GE Quality Product**

**Owner's Manual and  
Installation Instructions**

RA620

RA624

*Safety Instructions* . . . . . 2-4

***Operating Instructions***

Oven . . . . . 6-9  
Surface Units . . . . . 5

***Care and Cleaning***

Broiler Pan and Grid . . . . . 11  
Cooktop . . . . . 10  
Knobs . . . . . 12  
Oven Door . . . . . 11  
Oven Heating Elements . . . . . 11  
Oven Interior . . . . . 12  
Painted Surfaces . . . . . 12  
Shelves . . . . . 10  
Surface Units and Drip Pans . . . 10

***Installation Instructions***

Anti-Tip Bracket . . . . . 13, 19  
Dimensions and Clearances . . . 14  
Electrical Connections . . . . 15-18  
Flooring . . . . . 14  
Leveling . . . . . 19  
Preparation . . . . . 14  
Tools You Will Need . . . . . 14

***Troubleshooting Tips*** . . . . . 20

***Consumer Support***

Consumer Support . . . Back Cover  
Product Registration . . . . . 21, 22  
Warranty . . . . . 23

**Write the model and serial  
numbers here:**

**Model #** \_\_\_\_\_

**Serial #** \_\_\_\_\_

You can find them on a label  
behind the bottom kick panel.

# IMPORTANT SAFETY INFORMATION. READ ALL INSTRUCTIONS BEFORE USING.

## **⚠ WARNING!**

For your safety, the information in this manual must be followed to minimize the risk of fire or explosion, electric shock, or to prevent property damage, personal injury, or loss of life.



## **⚠ WARNING ANTI-TIP DEVICE**

All ranges can tip and injury could result.

To prevent accidental tipping of the range, attach it to the floor by installing the Anti-Tip device supplied.

The device engages one of the rear leveling legs (see Installation Instructions).

To check if the device is installed properly, carefully tip the range forward.

If the Anti-Tip device supplied with the range does not fit this application, use the universal Anti-Tip device WB2X7909.



If you pull the range out from the wall for any reason, make sure the rear leg is returned to its position in the device when you push the range back.



## SAFETY PRECAUTIONS

When using electrical appliances, basic safety precautions should be followed, including the following:

- Use this appliance only for its intended use as described in this manual.
- Be sure your appliance is properly installed and grounded by a qualified technician in accordance with the provided installation instructions.
- Don't attempt to repair or replace any part of your range unless it is specifically recommended in this manual. All other servicing should be referred to a qualified technician.
- Before performing any service recommended in these instructions, **DISCONNECT THE RANGE POWER SUPPLY AT THE HOUSEHOLD DISTRIBUTION PANEL BY REMOVING THE FUSE OR SWITCHING OFF THE CIRCUIT BREAKER.**
- Do not leave children alone—children should not be left alone or unattended in an area where an appliance is in use. They should never be allowed to sit or stand on any part of the appliance.
- Don't allow anyone to climb, stand or hang on the door or range top. They could damage the range and even tip it over, causing severe personal injury.
- **CAUTION:** ITEMS OF INTEREST TO CHILDREN SHOULD NOT BE STORED IN CABINETS ABOVE A RANGE OR ON THE BACKSPASH OF A RANGE—CHILDREN CLIMBING ON THE RANGE TO REACH ITEMS COULD BE SERIOUSLY INJURED.
- Never wear loose-fitting or hanging garments while using the appliance. Flammable material could be ignited if brought in contact with hot heating elements and may cause severe burns.
- Use only dry pot holders—moist or damp pot holders on hot surfaces may result in burns from steam. Do not let pot holders touch hot heating elements. Do not use a towel or other bulky cloth.
- For your safety, never use your appliance for warming or heating the room.
- Storage in or on appliance—Flammable materials should not be stored in an oven or near surface units.



## **⚠ WARNING!** SAFETY PRECAUTIONS

- Keep hood and grease filters clean to maintain good venting and to avoid grease fires.
- Do not let cooking grease or other flammable materials accumulate in or near the range.
- Do not use water on grease fires. Never pick up a flaming pan. Smother flaming pan on surface unit by covering pan completely with well-fitting lid, cookie sheet or flat tray. Flaming grease outside a pan can be put out by covering with baking soda or, if available, a multi-purpose dry chemical or foam-type fire extinguisher.
- Do not touch heating elements or interior surface of oven. These surfaces may be hot enough to burn even though they are dark in color. During and after use, do not touch, or let clothing or other flammable materials contact surface units, areas nearby the surface units or any interior area of the oven; allow sufficient time for cooling first.  
Potentially hot surfaces include the cooktop and areas facing the cooktop, oven vent opening and surfaces near the opening, and crevices around the oven door. Remember: The inside surface of the oven may be hot when the door is opened.



## COOK MEAT AND POULTRY THOROUGHLY...

*Cook meat and poultry thoroughly—meat to at least an INTERNAL temperature of 160°F and poultry to at least an INTERNAL temperature of 180°F. Cooking to these temperatures usually protects against foodborne illness.*



## OVEN

*Stand away from range when opening oven door. Hot air or steam which escapes can cause burns to hands, face and/or eyes.*

- Don't heat unopened food containers in the oven. Pressure could build up and the container could burst, causing an injury.
- Keep oven free from grease buildup.
- Place oven shelf in desired position while oven is cool. If shelves must be handled when hot, do not let pot holder contact heating elements in the oven.
- Pulling out shelf to the shelf stop is a convenience in lifting heavy foods. It is also a precaution against burns from touching hot surfaces of the door or oven walls.
- When using cooking or roasting bags in oven, follow the manufacturer's directions.
- Do not use your oven to dry newspapers. If overheated, they can catch fire.
- Keep the oven vent ducts unobstructed.

## IMPORTANT SAFETY INFORMATION. READ ALL INSTRUCTIONS BEFORE USING.

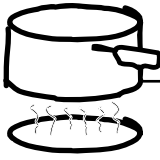

### SURFACE COOKING UNITS

*Use proper pan size—This appliance is equipped with one or more surface units of different size. Select cookware having flat bottoms large enough to cover the surface unit heating element. The use of undersized cookware will expose a portion of the heating element to direct contact and may result in ignition of clothing. Proper relationship of cookware to burner will also improve efficiency.*

- Never leave surface units unattended at high heat settings. Boilover causes smoking and greasy spillovers that may catch on fire.
- Be sure drip pans are in place. Their absence during cooking could damage range parts and wiring.
- Don't use aluminum foil to line drip pans or anywhere in the oven except as described in this guide. Misuse could result in a shock, fire hazard or damage to the range.
- Only certain types of glass, glass/ceramic, earthenware or other glazed containers are suitable for range-top service; others may break because of the sudden change in temperature.
- To minimize the possibility of burns, ignition of flammable materials, and spillage, the handle of a container should be turned toward the center of the range without extending over nearby surface units.
- Always turn surface unit to **OFF** before removing cookware.
- Keep an eye on foods being fried at **HI** or **MEDIUM HIGH** heats.
- To avoid the possibility of a burn or electric shock, always be certain that the controls for all surface units are at **OFF** position and all coils are cool before attempting to lift or remove the unit.
- Don't immerse or soak removable surface units. Don't put them in a dishwasher.
- When flaming foods under the hood, turn the fan on.
- Foods for frying should be as dry as possible. Frost on frozen foods or moisture on fresh foods can cause hot fat to bubble up and over sides of pan.
- Use little fat for effective shallow or deep-fat frying. Filling the pan too full of fat can cause spillovers when food is added.
- If a combination of oils or fats will be used in frying, stir together before heating, or as fats melt slowly.
- Always heat fat slowly, and watch as it heats.
- Use a deep-fat thermometer whenever possible to prevent overheating fat beyond the smoking point.
- Use extreme caution when moving a grease filled pan or disposing of hot grease.



**READ AND FOLLOW THIS SAFETY INFORMATION CAREFULLY.  
SAVE THESE INSTRUCTIONS**

Throughout this manual, features and appearance may vary from your model.

## Surface Cooking Controls

Your surface units and controls are designed to give you a variety of heat settings for surface unit cooking.

At both **LO** and **HI** positions, there is a slight niche so control **clicks** at those positions; **HI** marks the highest setting; **LO**, the lowest setting.

In a quiet kitchen, you may hear slight **clicking** sounds during cooking, indicating heat settings selected are being maintained.

Switching heats to higher settings always shows a quicker change in temperature than switching to lower settings.

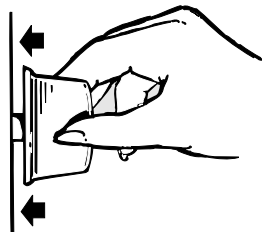

## How to Set the Controls

- 1 Push the control knob in.
- 2 Turn either clockwise or counterclockwise to desired heat setting.

Control must be pushed in to set only from the **OFF** position.

When control is in any position other than **OFF**, you can turn it without pushing in.

Be sure you turn control to **OFF** when you finish cooking. An indicator light will glow when **ANY** surface unit is on.

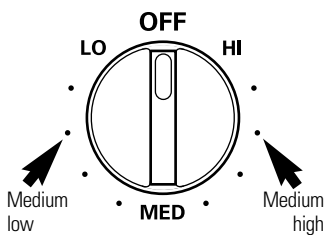

## Heat Setting Guide

**HI** – Quick start for cooking; bring water to boil.

**MEDIUM HIGH** – Fast fry, pan broil; maintain fast boil on large amount of food.

**MED** – Saute and brown; maintain slow boil on large amount of food.

**MEDIUM LOW** – Steam rice, cereal; maintain serving temperature of most foods.

**LO** – Cook after starting at HI; cook with little water in covered pan.

### NOTE:

- 1 At **HI** or **MEDIUM HIGH**, never leave food unattended. Boilovers cause smoking; greasy spillovers may catch fire.
- 2 At **LO**, melt chocolate, butter on small unit.

## Cooking Tips

- Use medium- or heavyweight cookware. Aluminum cookware conducts heat faster than other metals. Cast-iron and coated cast-iron cookware is slow to absorb heat, but generally cooks evenly at low or medium heat settings. Steel pans may cook unevenly if not combined with other metals.
- Do not overfill cookware with fat that may spill over when adding food. Frosty foods bubble vigorously. Watch foods frying at high temperatures. Keep range and hood clean from accumulated grease.

- To conserve the most cooking energy, pans should be flat on the bottom, have straight sides and tight-fitting lids. Match the size of the saucepan to the size of the surface unit. A pan that extends more than an inch beyond the edge of the drip pan traps heat, which causes “crazing” (fine hairline cracks) on porcelain, and discoloration ranging from blue to dark gray on chrome drip pans.

## Using the oven.

The **OVEN TEMP** knob is located on the control panel on the front of the range.

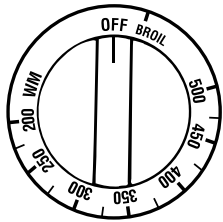

### Oven Temperature Control

To use the oven, simply turn the knob to the desired cooking temperatures, which are marked in 25°F increments on the dial. **OVEN TEMP** maintains the temperature you set, from **WARM** to **BROIL**.

*The Oven Cycling Light glows until the oven reaches your selected temperature, then goes off and on with the oven unit(s) during cooking.*

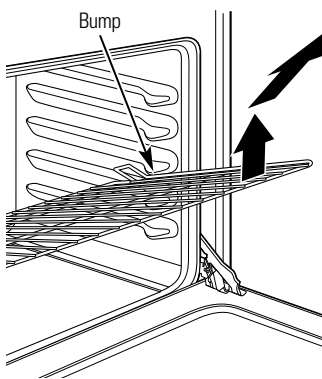

### Oven Shelves

The shelves are designed with stop-locks so when placed correctly on the shelf supports, they will stop before coming completely out of the oven and will not tilt when you are removing food from them or placing food on them.

When placing cookware on a shelf, pull the shelf out to the bump on the shelf support. Place the cookware on the shelf, then slide the shelf back into the oven. This will eliminate reaching into the hot oven.

**To remove the shelves from the oven**, pull them toward you, tilt front end upward and pull them out.

**To replace**, place shelf on shelf support with stop-locks (curved extension of shelf) facing up and toward back of oven. Tilt up front and push shelf toward back of oven until it goes past the bump on the shelf support. Then lower front of shelf and push it all the way back.

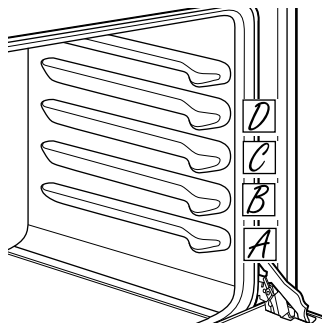

The oven has 4 shelf positions.

### Oven Shelf Positions

The oven has four shelf supports—**A** (bottom), **B**, **C** and **D** (top).

Shelf positions for cooking are suggested on Baking and Roasting pages.

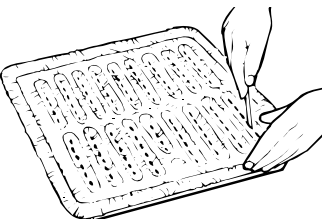

### Use of Aluminum Foil

■ If desired, a sheet of aluminum foil may be used on the floor of the oven under the bake element. **Be certain foil does not touch bake element.** Aluminum foil used in this way may slightly affect the browning of some foods. Change foil when it becomes soiled.

■ **DO NOT** place a sheet of aluminum foil on the shelf. To do so may result in improperly cooked foods, damage to oven finish and increase in heat on outside surfaces of the oven.

You may use aluminum foil to line the broiler pan and broiler grid. However, you must mold the foil tightly to the grid and cut slits in it just like the grid.

# Using the oven for baking or roasting.

www.GEAppliances.com

To avoid possible burns, place the shelves in the desired position before you turn the oven on.

## How to Set Your Oven for Baking or Roasting

- 1 Position the shelf or shelves in the oven. If cooking on two shelves at the same time, stagger the pans for best heat circulation.
- 2 Close oven door. Turn **OVEN TEMP** knob clockwise to desired temperature. Preheat oven for at least 10 minutes if preheating is necessary.
- 3 Place food in oven on center of shelf. Allow at least 2 inches between edge of bakeware and oven wall or adjacent cookware.
- 4 Check food for doneness at minimum time on recipe. Cook longer if necessary. Turn **OVEN TEMP** knob to **OFF** and remove food.

## Shelf Positions

- Most baking is done on the second shelf position (**B**) from the bottom.
- When baking three or four items, use two shelves positioned on the second and fourth sets of supports (**B & D**) from bottom of oven.
- Bake angel food cakes on first shelf position (**A**) from bottom of oven.
- Roasting is usually done on the bottom shelf position (**A**).

## Preheating

- Preheating the oven takes about 10 minutes.
- Preheat the oven only when necessary, usually for baking.
- Most roasts will cook satisfactorily without preheating.
- If you find preheating is necessary, keep an eye on the indicator light and put food in the oven promptly after the light goes out. The oven Indicator Light will then cycle on and off with the oven thermostat as it cycles to maintain oven temperature.

## Baking and Roasting Tips

- Follow a tested recipe and measure the ingredients carefully. If you are using a package mix, follow label directions.
- Do not open the oven door during a baking operation—heat will be lost and the baking time might need to be extended. This could cause poor baking results. If you must open the door, open it partially—only 3 or 4 inches—and close it as quickly as possible.
- Roasting is cooking by dry heat. Tender meat or poultry can be roasted uncovered in your oven. Roasting temperatures, which should be low and steady, keep spattering to a minimum. When roasting, it is not necessary to sear, baste, cover or add water to your meat.
- Frozen roasts of beef, pork, lamb, etc., can be started without thawing, but allow 10 to 25 minutes per pound additional time (10 minutes per pound for roasts under 5 pounds, more time for larger roasts).
- Thaw most frozen poultry before roasting to ensure even doneness. Some commercial frozen poultry can be cooked successfully without thawing. Follow directions given on package label.

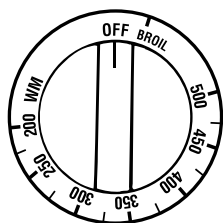

Safety Instructions

Operating Instructions

Care and Cleaning

Installation Instructions

Troubleshooting Tips

Consumer Support

## Adjust the oven thermostat—Easy to do yourself!

You may find that your new oven cooks differently than the one it replaced. Use your new oven for a few weeks to become more familiar with it. If you still think your new oven is too hot or too cold, you can adjust the thermostat yourself.

Do not use thermometers, such as those found in grocery stores, to check the temperature setting of your oven. These thermometers may vary 20–40°F.

**NOTE:** This adjustment will not affect the broiling temperatures. The adjustment will be retained after a power failure.

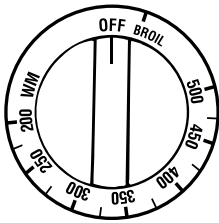

Front of OVEN TEMP knob  
(knob appearance may vary)

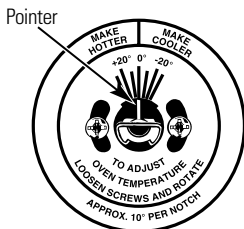

Back of OVEN TEMP knob

### To Adjust the Thermostat with this Type of Knob

- 1 Pull the Oven Temp knob off the shaft, look at the back of the knob and note the current setting **before** making any adjustments.
- 2 Loosen both screws on the back of the knob.
- 3 To **increase** the oven temperature, move the pointer toward the words **"MAKE HOTTER."**

To **decrease** the oven temperature, turn the pointer toward the words **"MAKE COOLER."**

Each notch changes the temperature by 10°F.

- 4 Tighten the screws.
- 5 Replace the knob, matching the flat area of the knob to the shaft.

## The type of margarine will affect baking performance!

Most recipes for baking have been developed using high-fat products such as butter or margarine (80% fat). If you decrease the fat, the recipe may not give the same results as with a higher fat product.

Recipe failure can result if cakes, pies, pastries, cookies or candies are made with low-fat spreads. The lower the fat content of a spread product, the more noticeable these differences become.

Federal standards require products labeled "margarine" to contain at least 80% fat by weight. Low-fat spreads, on the other hand, contain less fat and more water. The high moisture content of these spreads affects the texture and flavor of baked goods. For best results with your old favorite recipes, use margarine, butter or stick spreads containing at least 70% vegetable oil.



# Using the oven for broiling.

Broiling may be slightly different from any previous broiling you may be acquainted with, so be sure to read this section completely.

## How to Set Your Oven for Broiling

Broiling is cooking food by intense radiant heat from the upper element in the oven. Most fish and tender cuts of meat can be broiled. Follow these steps to keep spattering and smoking to a minimum.

- 1 If the meat has fat or gristle around the edge, cut vertical slashes through both about 2" apart. If desired, fat may be trimmed, leaving a layer about 1/8" thick.
- 2 Place the meat on the broiler grid in the broiler pan which comes with your range. Always use the grid so the fat drips into the broiler pan; otherwise the juices may become hot enough to catch fire.
- 3 Place the shelf in position **C** for most broiling.
- 4 Close the door. **Always broil with the door closed.**
- 5 Turn the **OVEN TEMP** knob clockwise to **BROIL**. You will feel a slight niche at the broil position.
- 6 Turn food only once during cooking.
- 7 Turn the **OVEN TEMP** knob to **OFF**. Serve food immediately, and leave the pan outside the oven to cool during the meal for easiest cleaning.

## Broiling Guide

- If desired, marinate meats or chicken before broiling, or brush with barbecue sauce the last 5 to 10 minutes only.
- Frozen steaks can be broiled by positioning the oven shelf at the next lowest shelf position and increasing cooking time given in this guide 1½ times per side.
- When arranging food on pan, do not let fatty edges hang over sides because the dripping fat will soil the oven.
- If your range is connected to 208 volts, rare steaks may be broiled by preheating the broiler and positioning the oven shelf one position higher.

Food	Amount or Thickness	Shelf Position	Time In Minutes		Comments
			First Side	Second Side	
<b>Bacon</b>	1/2 lb. (about 8 thin slices)	C	3½ min.	3½ min.	Arrange in single layer.
<b>Ground Beef</b>	1 lb. (4 patties) 1/2 to 3/4" thick	C	10 min.	7 min.	Space evenly.
<b>Beef Steaks</b> Medium	1" thick 1 to 1½ lbs.	C	9 min.	9 min.	Steaks less than 1" thick cook through before browning. Pan frying is recommended. Slash fat.
<b>Chicken</b>	1 whole 2 to 2½ lbs., split lengthwise	A	35 min.	15 min.	Reduce time about 5 to 10 minutes per side for cut-up chicken. Brush each side with melted butter. Broil skin-side-down first.
<b>Fish</b>	1 lb. fillets 1/4 to 1/2" thick	C	5 min.	5 min.	Handle and turn very carefully. Brush with lemon butter before and during cooking, if desired. Preheat broiler to increase browning.

## Care and cleaning of the range.

Be sure electrical power is off and all surfaces are cool before cleaning any part of the range.

Proper care and cleaning are important so your range will give you efficient and satisfactory service. Follow these directions carefully in caring for your range to assure safe and proper maintenance.

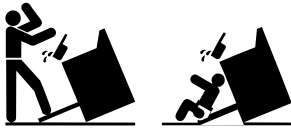

If your range is removed for cleaning, servicing or any reason, be sure the anti-tip device is reengaged properly when the range is replaced. Failure to take this precaution could result in tipping of the range and cause injury.

### Porcelain Enamel Cooktop

The porcelain enamel finish is sturdy but breakable if misused. This finish is acid-resistant. However, any acidic foods spilled (such as fruit juices, tomato or vinegar) should not be permitted to remain on the finish.



### Oven Shelves

Clean the shelves with an abrasive cleanser or steel wool.

After cleaning, rinse the shelves with clean water and dry with a clean cloth.

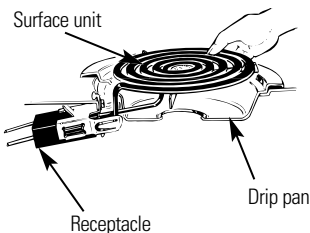

To remove the surface unit, lift it about 1 inch above the drip pan and pull it out.

### Surface Units and Drip Pans

To clean the surface units, turn the control to the highest setting for a minute. The coils will burn off any soil.

#### To remove a surface unit:

To remove the drip pans for cleaning, the surface units must be removed first. Make sure the surface units are cool before touching them.

Lift the surface unit about 1 inch above the drip pan and pull it out.

*Do not lift the surface unit more than 1 inch. If you do, it may not lie flat on the drip pan when you plug it back in.*

**NOTE:** Repeated lifting of the surface unit more than 1 inch above the drip pan can permanently damage the receptacle.

#### To replace a surface unit:

Replace the drip pan into the recess in the cooktop. Make sure the opening in the pan lines up with the receptacle.

Insert the terminals of the surface unit through the opening in the drip pan and into the receptacle.

Guide the surface unit into place so it rests evenly.

#### To clean the drip pans:

Drip pans can be cleaned in the dishwasher or by hand. If you use a scouring pad, rub lightly to prevent scratching.

#### Q Can I cover the drip pans with foil?

A No, because using foil so close to the receptacle could cause shock, fire or damage to the range.

#### CAUTION:

- Do not immerse the surface units in liquids of any kind.
- Do not clean the surface units in a dishwasher.
- Do not bend the surface unit plug terminals.
- Do not attempt to clean, adjust or in any way repair the plug-in receptacle.



Replace the drip pan into the recess in the cooktop.

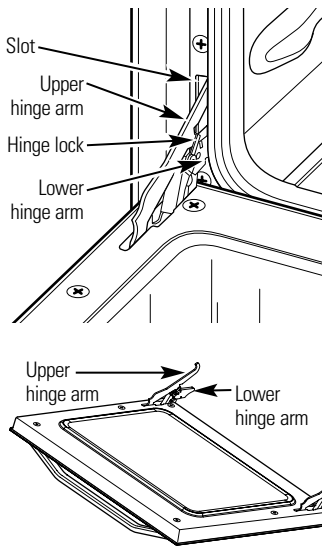

### Lift-Off Oven Door

The oven door is removable, but it is heavy. You may need help removing and replacing the door.

#### To remove the door:

- 1 Open the door to the full open position.
- 2 Pull the hinge locks up over the hinge hooks on both sides.
- 3 Grasp the door firmly on each side, lift slightly and pull it straight out and away from the oven.

#### To replace the door:

- 1 Firmly grasp both sides of the door at the top.
- 2 Insert and seat the upper and lower hinge arms into the oven slots.
- 3 Push the hinge locks down from the hinge hooks.
- 4 Close the oven door and make sure it is working properly. If it is not working properly, remove and replace it following the above steps.

*DO NOT ATTEMPT TO CLOSE THE DOOR UNTIL THIS STEP IS COMPLETE. THE HINGE OR DOOR COULD BE DAMAGED.*

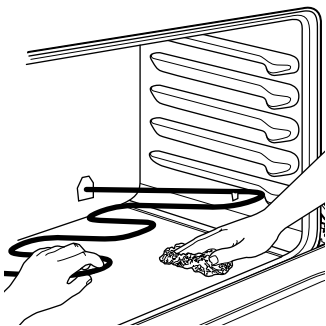

### Oven Heating Elements

Do not clean the bake element or the broil element. Any soil will burn off when the elements are heated.

The bake element can be lifted gently to clean the oven floor. If spillovers, residue or ash accumulate around the bake element, gently wipe around the element with warm water.

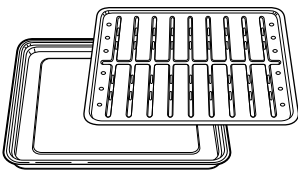

*Both the broiler pan and grid can also be cleaned in the dishwasher.*

### Broiler Pan and Grid

After broiling, remove the broiler pan from the oven. Remove the grid from the pan. Carefully pour out grease from the pan into a proper container. Wash and rinse the broiler pan and grid in hot water with a soap-filled or plastic scouring pad.

If food has burned on, sprinkle the grid with detergent while hot and cover with wet paper towels or a dishcloth. Soaking the pan will remove burned on foods.

*Do not store a soiled broiler pan and grid anywhere in the range.*

## Care and cleaning of the range.

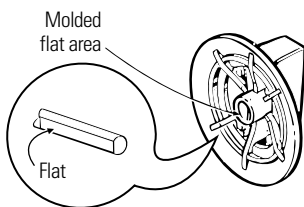

### Control Knobs

The control knobs may be removed for easier cleaning.

To remove a knob, pull it straight off the stem.

Wash the knobs in soap and water but do not soak. Avoid getting water down in the knob stem holes.

Replace the knob by fitting the molded flat area inside the knob onto the flat area of the stem.

### Painted Surfaces

Painted surfaces include the sides, control panel, door and kick panel. Clean these with soap and water or a vinegar and water solution.

*Do not use commercial oven cleaners, cleansing powders, steel wool or harsh abrasives on any painted surface.*

### Porcelain Oven Interior

*With proper care, the porcelain enamel interior will retain its attractive finish for many years.*

Soap and water will normally do the job. Heavy spattering or spillovers may require cleaning with a mild abrasive cleanser. Soapy, wet pads may also be used. Do not allow food spills with a high sugar or acid content (such as milk, tomatoes, sauerkraut, fruit juices or pie filling) to remain on the surface. They may cause dull spots even after cleaning.

Household ammonia may make the cleaning job easier. Place 1/2 cup ammonia in a shallow glass pan and leave in a cold oven overnight. The ammonia fumes will help loosen the burned-on grease and food.

When necessary, you may use a commercial oven cleaner. Follow the package directions.

### Cautions about using spray-on oven cleaners:

- Do not spray the oven cleaner on the electrical controls and switches because it could cause a short circuit and result in sparking or fire.
- Do not directly spray oven cleaner onto the oven heating elements.
- Do not allow a film from the cleaner to remain on the temperature sensor—it could cause the oven to heat improperly. (The sensor is located at the top of the oven.) Carefully wipe the bulb clean after each oven cleaning, being careful not to move the sensor since a change in its position could affect how the oven bakes.
- Do not spray any oven cleaner on the outside oven door, handles or any exterior surface of the oven, cabinet or painted surfaces. The cleaner can damage these surfaces.

# Installation Instructions

# 20" and 24" Compact Electric Ranges

? Questions? Call 800.GE.CARES (800.432.2737) or Visit our Website at: [GEAppliances.com](http://GEAppliances.com)

## BEFORE YOU BEGIN

Read these instructions completely and carefully.

- **IMPORTANT** — Save these instructions for local inspector's use.
- **IMPORTANT** — Observe all governing codes and ordinances.
- **Note to Installer** – Be sure to leave these instructions with the Consumer.
- **Note to Consumer** – Keep these instructions for future reference.
- **Skill level** – Installation of this appliance requires basic mechanical skills.
- **Completion time** – 1 to 3 hours
- Proper installation is the responsibility of the installer.
- Product failure due to improper installation is not covered under the Warranty.

**▲ WARNING** — This appliance must be properly grounded.

## FOR YOUR SAFETY:

**▲ WARNING** — Before beginning the installation, switch power off at service panel and lock the service disconnecting means to prevent power from being switched on accidentally. When the service disconnecting means cannot be locked, securely fasten a prominent warning device, such as a tag, to the service panel.

## FOR YOUR SAFETY:

All rough-in and spacing dimensions must be met for safe use of your range. Electricity to the range can be disconnected at the outlet without moving the range if the outlet is in the preferred location (remove lower drawer).

To reduce the risk of burns or fire when reaching over hot surface elements, cabinet storage space above the cooktop should be avoided. If cabinet storage space is to be provided above the cooktop, the risk can be reduced by installing a range hood that sticks out at least 5" beyond the front of the cabinets. Cabinets installed above a cooktop must be no deeper than 13".

Be sure your appliance is properly installed and grounded by a qualified technician.

Make sure the cabinets and wall coverings around the range can withstand the temperatures (up to 200°F.) generated by the range.

## ANTI-TIP DEVICE

**▲ WARNING** — To reduce the risk of tipping, the appliance must be secured by properly installed Anti-Tip bracket packed with this appliance.

If the Anti-Tip device supplied with the range does not fit this application, use the universal Anti-Tip device WB2X7909.



### **▲ WARNING** —

- All ranges can tip
- Injury to persons could result
- Install Anti-Tip bracket packed with range
- See Installation Instructions

If you pull the range out and away from the wall for any reason, make sure the Anti-Tip bracket is engaged when the range is pushed back against the wall.

# Installation Instructions

## PREPARE TO INSTALL THE RANGE

### MATERIALS YOU MAY NEED

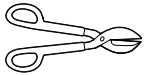

Tin Snips



Lag Bolts



Anchor Sleeves

(For Anti-Tip Bracket Mounted on Concrete Floors Only)



(UL Approved 40 AMP)

4-Wire Cord **OR** 3-Wire Cord  
4' Long 4' Long

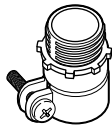

Squeeze Connector  
(For Conduit Installations Only)

### TOOLS YOU WILL NEED

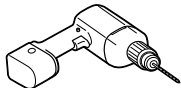

Drill with 1/8" Bit



Safety Glasses



Adjustable Wrench

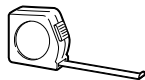

Tape Measure

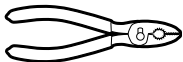

Pliers



Pencil

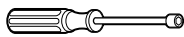

1/4" Nut Driver



Level



Phillips Screwdriver

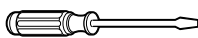

Flat-blade  
Screwdriver

### PARTS INCLUDED



Anti-Tip Bracket Kit

## 1 REMOVE SHIPPING MATERIALS

Remove packaging materials. Failure to remove packaging materials could result in damage to the appliance.

## 2 PREPARE THE OPENING

- See the illustration below for all rough-in and spacing dimensions. These dimensions must be met for safe use of your range.
- The range may be placed with 0" clearance at the back wall and 2" minimum clearance at side walls of the range if the front edges of the range side panels protrude beyond the cabinet fronts at least 1/4".
- To eliminate the risk of burns or fire when reaching over hot surface elements, cabinet storage space above the cooktop should be avoided. If cabinet storage space is to be provided above the cooktop, the risk can be reduced by installing a range hood that protrudes at least 5" beyond the front of the cabinets. Cabinets installed above a cooktop may be no deeper than 13".

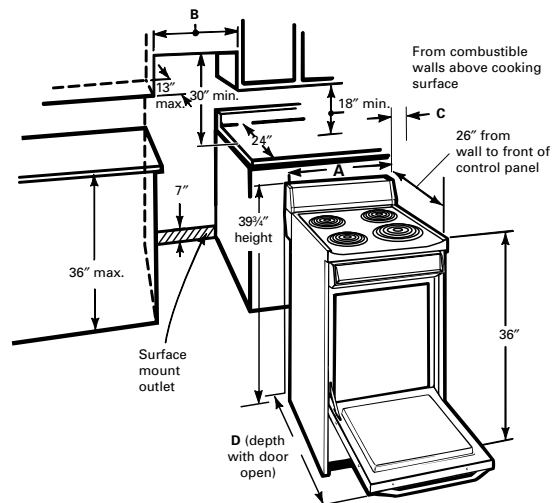

Models	A	B	C (recommended)	D
20" Wide	20"	20 3/8"	2"	39 3/8"
24" Wide	24"	24 3/8"	2"	40 1/2"

### Flooring under the range

Your range, like many other household items, is heavy and can settle into soft floor coverings such as cushioned vinyl or carpeting.

When moving the range on this type of flooring, it should be installed on a 1/4" thick sheet of plywood (or similar material) as follows:

When the floor covering ends at the front of the range, the area that the range will rest on should be built up with plywood to the same level or higher than the floor covering. This will allow the range to be moved for cleaning or servicing.

# Installation Instructions

## ELECTRICAL CONNECTIONS

### ELECTRICAL REQUIREMENTS

**▲ CAUTION:** For personal safety, do not use an extension cord with this appliance. Remove house fuse or open circuit breaker before beginning installation.

This appliance must be supplied with the proper voltage and frequency, and connected to an individual properly grounded branch circuit, protected by a circuit breaker or fuse having amperage as specified on the rating plate. The rating plate is located above the storage drawer on the oven frame.

We recommend you have the electrical wiring and hookup of your range connected by a qualified electrician. After installation, have the electrician show you where your main range disconnect is located.

Check with your local utilities for electrical codes which apply in your area. Failure to wire your oven according to governing codes could result in a hazardous condition. If there are no local codes, your range must be wired and fused to meet the requirements of the National Electrical Code, ANSI/NFPA No. 70–Latest Edition. You can get a copy by writing:

National Fire Protection Association  
Batterymarch Park  
Quincy, MA 02269

**Effective January 1, 1996, the National Electrical Code requires that new construction (not existing) utilize a 4-conductor connection to an electric range.**

**When installing an electric range in new construction, follow Steps 3 and 5 for 4-wire connection.**

You must use a 3-wire, single-phase A.C. 208Y/120 Volt or 240/120 Volt, 60 hertz electrical system. If you connect to aluminum wiring, properly installed connectors approved for use with aluminum wiring must be used.

If the electrical service provided does not meet the above specifications, have a licensed electrician install an approved outlet.



**ALL NEW BRANCH CIRCUIT INSTALLATIONS, MOBILE HOMES, RECREATIONAL VEHICLES AND INSTALLATIONS WHERE LOCAL CODES DO NOT ALLOW GROUNDING THROUGH NEUTRAL, REQUIRE A 4-CONDUCTOR CORD OR CONDUIT**

Use only a 3-conductor or a 4-conductor UL-listed range cord. Terminations must either be closed loop connectors or open end spade lugs.

A range cord rated at 40 amps with 125/250 minimum volt range is required. A 50 amp range cord is not recommended but if used, it should be marked for use with nominal 1 $\frac{3}{8}$ " diameter connection openings. Care should be taken to center the cable and strain relief within the knockout hole to keep the edge from damaging the cable.

- Because range terminals are not accessible after range is in position, flexible service conduit or cord must be used.

**NOTE:** If conduit is being used, go to Step 3D and then to Step 6 or 7.

- On some models, a filter capacitor may be connected between the black and white leads on the junction block.

# Installation Instructions

## ELECTRICAL CONNECTIONS (CONT.)

### 3 POWER CORD AND STRAIN RELIEF INSTALLATION

- A** Remove the wire cover (on the lower back of the range) by removing its top center screw.

**Do not discard this screw.**

- B** Remove the knockout ring ( $1\frac{3}{8}$ " ) located on bracket directly below the terminal block. To remove the knockout, use a pair of pliers to bend the knockout ring away from the bracket and twist until ring is removed.

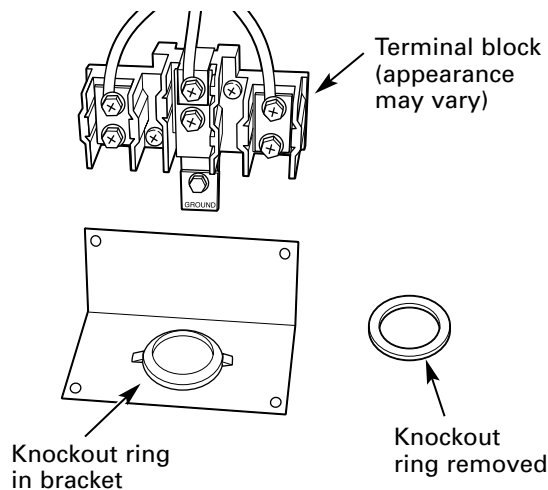

- C** For power cord installations only (see the next step if using conduit), assemble the strain relief in the hole. Insert the power cord through the strain relief and tighten. Allow enough slack to easily attach the cord terminals to the terminal block. If tabs are present at the end of the winged strain relief, they can be removed for better fit.

**NOTE: Do not install the power cord without a strain relief. The strain relief bracket should be installed before reinstalling the rear range wiring cover.**

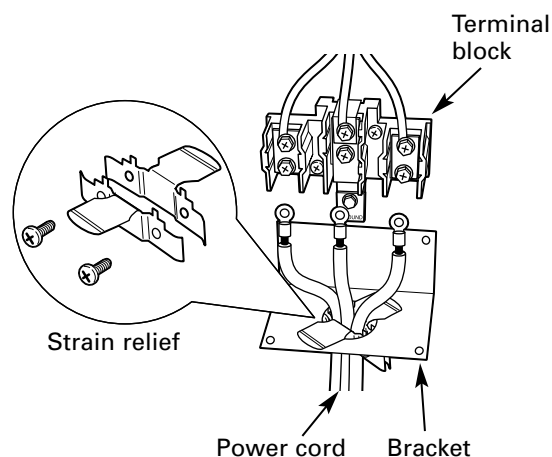

Skip to Step 4 or 5.

- D** For conduit installations only, purchase a squeeze connector matching the diameter of your conduit and assemble it in the hole. Insert the conduit through the squeeze connector and tighten. Allow enough slack to easily attach the wires to the terminal block.

**NOTE: Do not install the conduit without a squeeze connector. The squeeze connector should be installed before reinstalling the rear range wiring cover.**

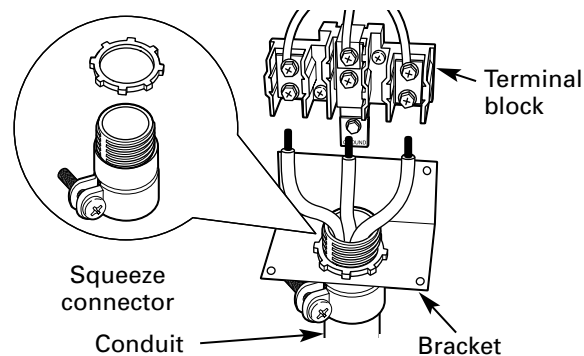

Skip to Step 6 or 7.



# Installation Instructions

## 4 3-WIRE POWER CORD INSTALLATION

**⚠ WARNING:** The neutral or ground wire of the power cord must be connected to the neutral terminal located in the center of the terminal block. The power leads must be connected to the lower left and the lower right terminals of the terminal block.

**A** Remove the 3 lower terminal screws from the terminal block. Insert the 3 terminal screws through each power cord terminal ring and into the lower terminals of the terminal block. Be certain that the center wire (white/neutral) is connected to the center lower position of the terminal block. Tighten screws securely into the terminal block.

**DO NOT remove the ground strap connection.**

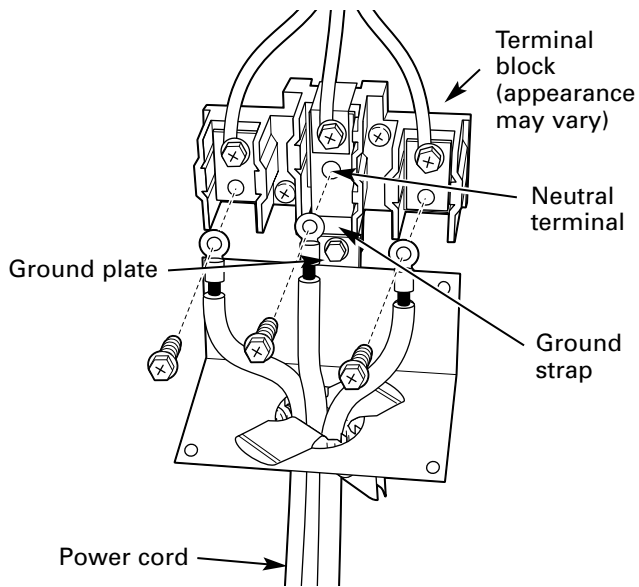

**B** Skip to Step 8 and proceed with the installation.

## 5 4-WIRE POWER CORD INSTALLATION

**⚠ WARNING:** The neutral wire of the supply circuit must be connected to the neutral terminal located in the lower center of the terminal block. The power leads must be connected to the lower left and the lower right terminals of the terminal block. The 4th grounding lead must be connected to the frame of the range with the ground plate and the ground screw.

**A** Remove the 3 lower terminal screws from the terminal block. Remove the ground screw and ground plate and retain them.

**B** Cut and discard the ground strap. **DO NOT DISCARD ANY SCREWS.**

**C** Insert the one ground screw into the power cord ground wire terminal ring, through the ground plate and into the frame of the range.

**D** Insert the 3 terminal screws (removed earlier) through each power cord terminal ring and into the lower terminals of the terminal block. Be certain that the center wire (white/neutral) is connected to the center lower position of the terminal block. Tighten screws securely into the terminal block.

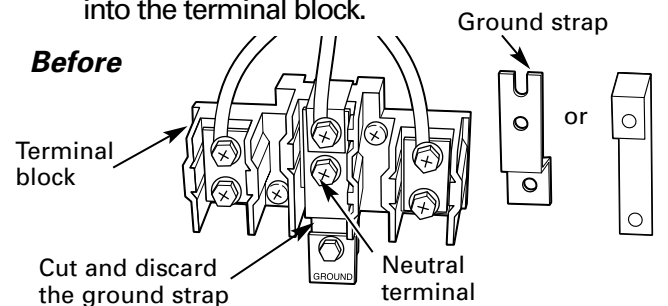

**After**

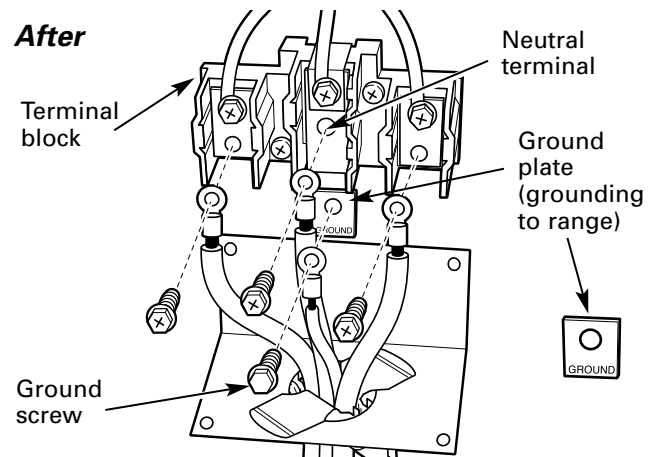

**E** Skip to Step 8 and proceed with the installation.

# Installation Instructions

## ELECTRICAL CONNECTIONS (CONT.)

### 6 3-WIRE CONDUIT INSTALLATION

- A** Loosen the 3 lower terminal screws from the terminal block. Insert the center bare wire (white/neutral) tip through the bottom center terminal block opening. On certain models, the wire will need to be inserted through the ground strap opening and then into the bottom center block opening. Insert the two side bare wire tips into the lower left and the lower right terminal block openings. Tighten the screws until the wire is firmly secure (approximately 35 inch-lbs.).

**NOTE: ALUMINUM WIRING:**

Aluminum building wire may be used but it must be rated for the correct amperage and voltage to make connection. Connect wires according to this Step 6 or Step 7 depending on number of wires.

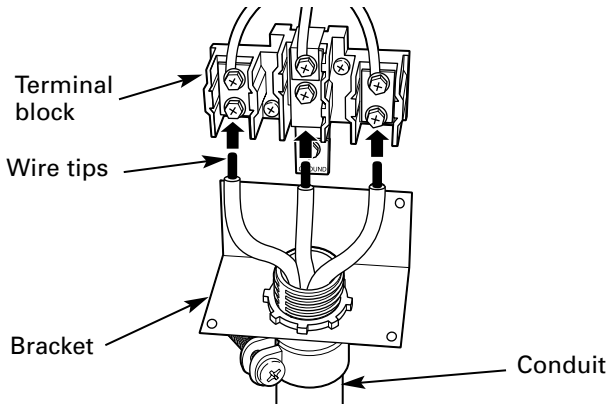

**Wire used, location and enclosure of splices, etc., must conform to good wiring practices and local codes.**

- B** Skip to Step 8 and proceed with the installation.

### 7 4-WIRE CONDUIT INSTALLATION

- A** Loosen the three lower terminal screws from the terminal block. Remove the ground screw and ground plate and retain them. **Cut and discard the ground strap. DO NOT DISCARD ANY SCREWS.**
- B** Insert the ground bare wire tip between the range frame and the ground plate (removed earlier) and secure it in place with the ground screw (removed earlier). Insert the bare wire (white/neutral) tip through the bottom center of the terminal block opening. Insert the two side bare wire tips into the lower left and the lower right terminal block openings. Tighten the screws until the wire is firmly secure (approximately 35 inch-lbs.).

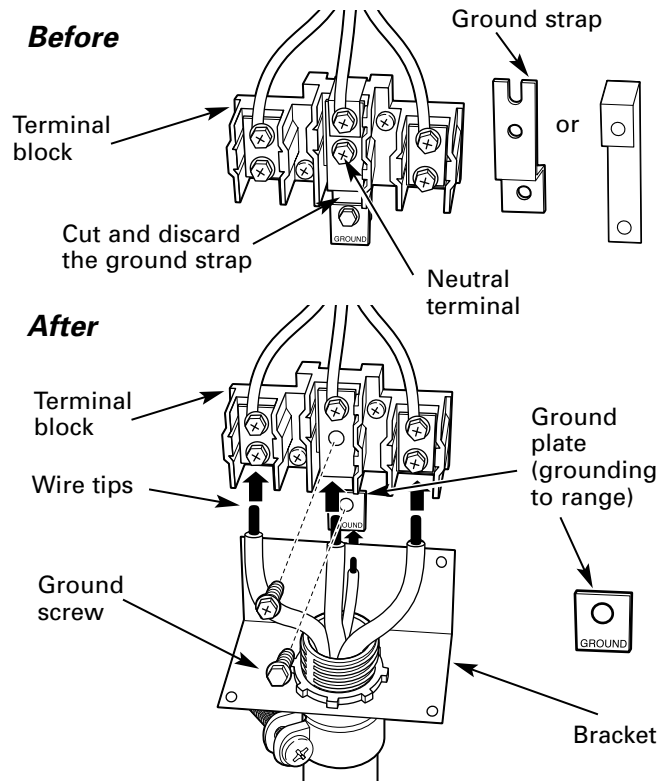

**Wire used, location and enclosure of splices, etc., must conform to good wiring practices and local codes.**

- C** Proceed to Step 8.

# Installation Instructions

## INSTALL THE RANGE

### 8 REPLACE THE WIRE COVER

Replace the wire cover on the range back by sliding its two lower retaining tabs into the slots and replacing the screw removed earlier. Make sure that no wires are pinched between the cover and the range back.

### 9 ANTI-TIP DEVICE INSTALLATION

#### ▲ WARNING:

- Range must be secured by **Anti-Tip bracket** supplied.
  - If the Anti-Tip device supplied with the range does not fit this application, use the universal Anti-Tip device WB2X7909.
  - Unless properly installed, the range could be tipped by stepping or sitting on the door. Injury may result from spilled hot liquids or from the range itself.
  - Anti-tip bracket attaches to the floor to hold either rear range leg. When fastening to the floor, be sure that the screws do not penetrate electrical wiring or plumbing. If you cannot be sure of this, use shorter screws that will not penetrate through the flooring.
- A** Decide whether the anti-tip bracket will be installed on the right or left side of the range location.
- B** If the bracket side of the range is next to a cabinet or wall, place the bracket  $1\frac{9}{16}$ " from the cabinet or wall. If there is no adjacent cabinet, determine where the location of the range side (painted outside panel) will be. Place the bracket so that the distance between the mounting holes (center line) is  $1\frac{3}{8}$ " from the side panel. Position the bracket so the back hole is  $2\frac{7}{16}$ " from the back wall.
- C** Screw the bracket securely to the floor with the screws provided. The screws are self-drilling in wood, plywood, particle and chip board, and most metal framing. If attaching to masonry, you can buy suitable screws and/or anchors at hardware stores. Use a masonry drill to drill the required holes.

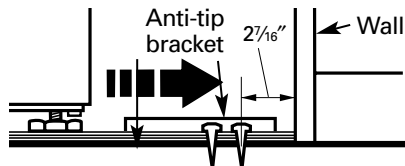

### 9 ANTI-TIP DEVICE INSTALLATION (cont.)

- D** Slide the range back toward the wall, being careful not to damage the sides or top of the range, or the adjacent cabinets. Make sure one of the rear leveling legs securely engages into the anti-tip bracket.

### 10 LEVEL THE RANGE

For proper cooking and baking, the range must be leveled. Leveling legs are located on each corner at the base of the range.

- A** Install the oven shelves (see **Using the oven** section for instructions). Put a spirit level or a glass measuring cup partially filled with water on one of the oven shelves.

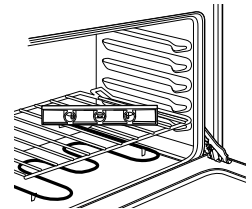

- B** Turn the legs clockwise to raise the range and counterclockwise to lower the range. Adjust the leveling legs until the range is level.

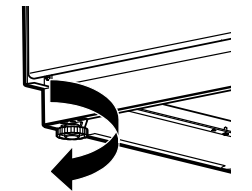

### 11 FINAL INSTALLATION CHECKLIST

- Check to make sure the circuit breaker is closed (RESET) or the circuit fuses are replaced.
- Be sure power is in service to the building.
- Check to be sure that all packing materials and tape have been removed. This will include tape on metal panel under control knobs (if applicable), adhesive tape, wire ties, cardboard and protective plastic. Failure to remove these materials could result in damage to the appliance once the appliance has been turned on and surfaces have heated.
- Check to make sure that the rear leveling leg is fully inserted into the Anti-Tip bracket and that the bracket is securely installed.
- Be sure all range controls are in the OFF position before leaving the range.

## Before You Call For Service...



*Troubleshooting Tips*  
Save time and money! Review the chart on this page first and you may not need to call for service.

<b>Problem</b>	<b>Possible Causes</b>	<b>What To Do</b>
<b>Surface units not functioning properly</b>	The surface units are not plugged in solidly.	<ul style="list-style-type: none"> <li>With the controls off, check to make sure the surface unit is plugged completely into the receptacle.</li> </ul>
	The surface unit controls improperly set.	<ul style="list-style-type: none"> <li>Check to see the correct control is set for the surface unit you are using.</li> </ul>
	The drip pans are not set securely in the cooktop.	<ul style="list-style-type: none"> <li>With the controls off, check to make sure the drip pan is in the recess in the cooktop and that the opening in the pan lines up with the receptacle.</li> </ul>
<b>Oven will not work</b>	A fuse in your home may be blown or the circuit breaker tripped.	<ul style="list-style-type: none"> <li>Replace the fuse or reset the circuit breaker.</li> </ul>
	Plug on range is not completely inserted in the electrical outlet.	<ul style="list-style-type: none"> <li>Make sure electrical plug is plugged into a live, properly grounded outlet.</li> </ul>
	Oven control improperly set.	<ul style="list-style-type: none"> <li>See the <i>Using the oven</i> sections.</li> </ul>
<b>Food does not broil properly</b>	Oven control improperly set.	<ul style="list-style-type: none"> <li>Make sure you turn the knob all the way to the <b>BROIL</b> position.</li> </ul>
	Improper shelf position being used.	<ul style="list-style-type: none"> <li>See the <i>Broiling Guide</i>.</li> </ul>
	Cookware not suited for broiling.	<ul style="list-style-type: none"> <li>Use the broiling pan and grid that came with your range.</li> </ul>
	Aluminum foil used on the the broiling pan and grid has not been fitted properly and slit as recommended.	<ul style="list-style-type: none"> <li>See the <i>Use of aluminum foil</i> section.</li> </ul>
<b>Food does not bake or roast properly</b>	Oven control improperly set.	<ul style="list-style-type: none"> <li>See the <i>Using the oven for baking or roasting</i> section.</li> </ul>
	Shelf position is incorrect or the shelf is not level.	<ul style="list-style-type: none"> <li>See the <i>Using the oven for baking or roasting</i> section.</li> </ul>
	Necessary preheating was not done.	<ul style="list-style-type: none"> <li>See the <i>Using the oven for baking or roasting</i> section.</li> </ul>
	Incorrect cookware or cookware of improper size being used.	<ul style="list-style-type: none"> <li>See the <i>Using the oven for baking or roasting</i> section.</li> </ul>

## GE Service Protection Plus™

GE, a name recognized worldwide for quality and dependability, offers you Service Protection Plus™—comprehensive protection on all your appliances—**No Matter What Brand!**

**Benefits Include:**

- Backed by GE
- All brands covered
- Unlimited service calls
- All parts and labor costs included
- No out-of-pocket expenses
- No hidden deductibles
- One 800 number to call

***We'll Cover Any Appliance.  
Anywhere. Anytime.\****

You will be completely satisfied with our service protection or you may request your money back on the remaining value of your contract. No questions asked. It's that simple.

Protect your refrigerator, dishwasher, washer and dryer, range, TV, VCR and much more—**any brand!** Plus there's no extra charge for emergency service and low monthly financing is available. Even icemaker coverage and food spoilage protection is offered. You can rest easy, knowing that all your valuable household products are protected against expensive repairs.

Place your confidence in GE and call us in the U.S. toll-free at **800.626.2224** for more information.

\*All brands covered, up to 20 years old, in the continental U.S.

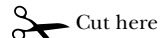

Please place in envelope and mail to:

***General Electric Company***  
**Warranty Registration Department**  
**P.O. Box 32150**  
**Louisville, KY 40232-2150**

# Consumer Product Ownership Registration

Dear Customer:

Thank you for purchasing our product and thank you for placing your confidence in us.

We are proud to have you as a customer!

Follow these three steps to protect your new appliance investment:

# 1

Complete and mail your Consumer Product Ownership Registration today. Have the peace of mind of knowing we can contact you in the unlikely event of a safety modification.

# 2

After mailing the registration below, store this document in a safe place. It contains information you will need should you require service. Our service number is 800.GE.CARES (800.432.2737).

# 3

Read your Owner's Manual carefully. It will help you operate your new appliance properly.

Model Number

Serial Number

**Important: If you did not get a registration card with your product, detach and return the form below to ensure that your product is registered, or register online at [www.GEAppliances.com](http://www.GEAppliances.com).**

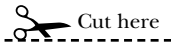

## Consumer Product Ownership Registration



Model Number

Serial Number

Mr.  Ms.  Mrs.  Miss

First Name

Last Name

Street Address

Apt. #

E-mail Address\*

City

State

Zip Code

Date Placed In Use  
Month

Day

Year

Phone Number --



**GE Appliances**

GE Consumer Products  
General Electric Company  
Louisville, Kentucky  
[www.GEAppliances.com](http://www.GEAppliances.com)

\* Please provide your e-mail address to receive, via e-mail, discounts, special offers and other important communications from GE Appliances (GEA).

Check here if you do not want to receive communications from GEA's carefully selected partners.

**FAILURE TO COMPLETE AND RETURN THIS CARD DOES NOT DIMINISH YOUR WARRANTY RIGHTS.**

For information about GEA's privacy and data usage policy, go to [www.GEAppliances.com](http://www.GEAppliances.com) and click on "Privacy Policy" or call 800.626.2224.

# Electric Range Warranty.



All warranty service provided by our Factory Service Centers, or an authorized Customer Care® technician. To schedule service, on-line, 24 hours a day, visit us at [www.GEAppliances.com](http://www.GEAppliances.com), or call 800.GE.CARES (800.432.2737).

Staple your receipt here.  
Proof of the original purchase date is needed to obtain service under the warranty.

## For The Period Of: We Will Replace:

### One Year

From the date of the original purchase

**Any part** of the range which fails due to a defect in materials or workmanship. During this **full one-year warranty**, GE will also provide, **free of charge**, all labor and in-home service to replace the defective part.

## What is Not Covered:

- Service trips to your home to teach you how to use the product.
- Improper installation, delivery or maintenance.
- Failure of the product if it is abused, misused, or used for other than the intended purpose or used commercially.
- Replacement of house fuses or resetting of circuit breakers.
- Damage to the product caused by accident, fire, floods or acts of God.
- Incidental or consequential damage caused by possible defects with this appliance.
- Damage caused after delivery.

*This warranty is extended to the original purchaser and any succeeding owner for products purchased for home use within the USA. In Alaska, the warranty excludes the cost of shipping or service calls to your home.*

*Some states do not allow the exclusion or limitation of incidental or consequential damages. This warranty gives you specific legal rights, and you may also have other rights which vary from state to state. To know what your legal rights are, consult your local or state consumer affairs office or your state's Attorney General.*

**Warrantor: General Electric Company, Louisville, KY 40225**

Safety Instructions

Operating Instructions

Care and Cleaning

Installation Instructions

Troubleshooting Tips

Consumer Support

## Consumer Support.

---



### *GE Appliances Website*

[www.GEAppliances.com](http://www.GEAppliances.com)

Have a question or need assistance with your appliance? Try the GE Appliances Website 24 hours a day, any day of the year! For greater convenience and faster service, you can now download Owner's Manuals, order parts, catalogs, or even schedule service on-line. You can also "Ask Our Team of Experts™" your questions, and so much more...



### *Schedule Service*

[www.GEAppliances.com](http://www.GEAppliances.com)

Expert GE repair service is only one step away from your door. Get on-line and schedule your service at your convenience 24 hours any day of the year! Or call 800.GE.CARES (800.432.2737) during normal business hours.



### *Real Life Design Studio*

[www.GEAppliances.com](http://www.GEAppliances.com)

GE supports the Universal Design concept—products, services and environments that can be used by people of all ages, sizes and capabilities. We recognize the need to design for a wide range of physical and mental abilities and impairments. For details of GE's Universal Design applications, including kitchen design ideas for people with disabilities, check out our Website today. For the hearing impaired, please call 800.TDD.GEAC (800.833.4322).



### *Extended Warranties*

[www.GEAppliances.com](http://www.GEAppliances.com)

Purchase a GE extended warranty and learn about special discounts that are available while your warranty is still in effect. You can purchase it on-line anytime, or call 800.626.2224 during normal business hours. GE Consumer Home Services will still be there after your warranty expires.

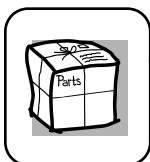

### *Parts and Accessories*

[www.GEAppliances.com](http://www.GEAppliances.com)

Individuals qualified to service their own appliances can have parts or accessories sent directly to their homes (VISA, MasterCard and Discover cards are accepted). Order on-line today, 24 hours every day or by phone at 800.626.2002 during normal business hours.

***Instructions contained in this manual cover procedures to be performed by any user. Other servicing generally should be referred to qualified service personnel. Caution must be exercised, since improper servicing may cause unsafe operation.***

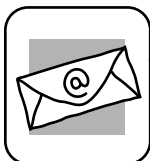

### *Contact Us*

[www.GEAppliances.com](http://www.GEAppliances.com)

If you are not satisfied with the service you receive from GE, contact us on our Website with all the details including your phone number, or write to: General Manager, Customer Relations  
GE Appliances, Appliance Park  
Louisville, KY 40225



### *Register Your Appliance*

[www.GEAppliances.com](http://www.GEAppliances.com)

**Register your new appliance on-line—at your convenience!** Timely product registration will allow for enhanced communication and prompt service under the terms of your warranty, should the need arise. You may also mail in the pre-printed registration card included in the packing material.