

HOTPOINT®

RGA720PK – Hotpoint 20" Free-Standing Gas Range

Dimensions (in inches)

Installation Information (in inches)

NOTE: Recommended gas hook-up locations behind range. Gas fittings and shut-off cock should NOT protrude more than 2" from the wall to allow the range to fit against the wall.

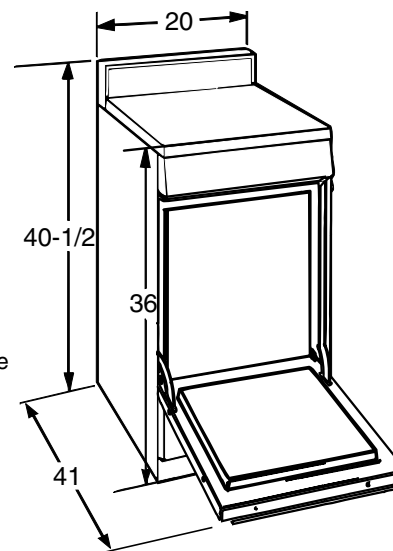
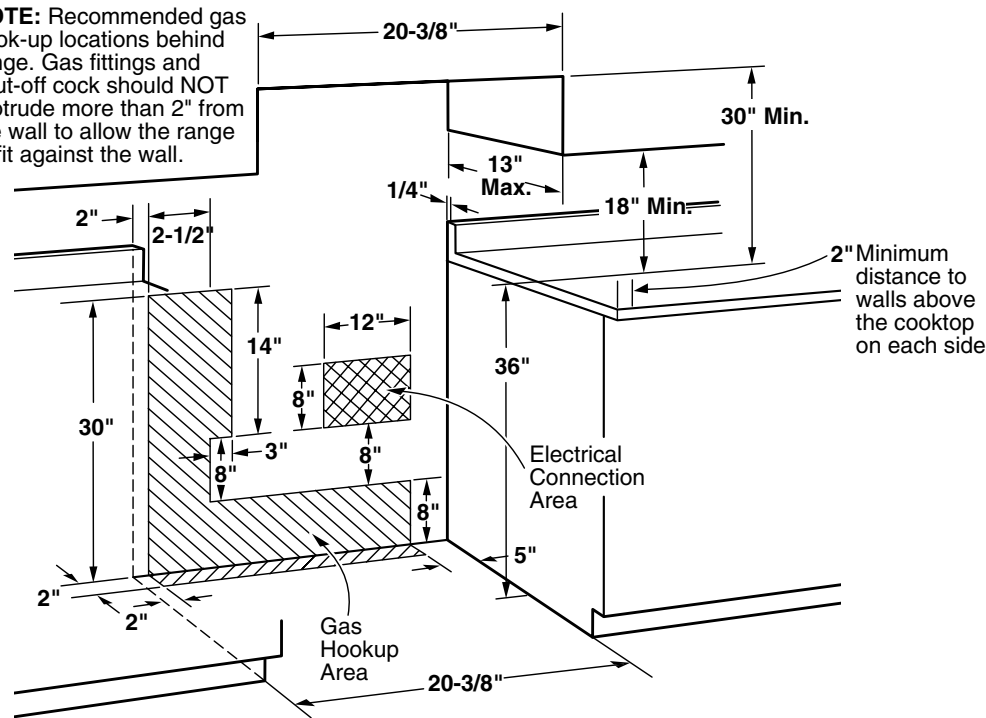

Electrical Rating: 120V, 60Hz, 5A

Installation Information: Before installing, consult installation instructions packed with product for current dimensional data.

Note: LP conversion kit is required for this model.



All GE ranges are equipped with an Anti-Tip device. The installation of this device is an important, required step in the installation of the range.



RGA720PK – Hotpoint 20" Free-Standing Gas Range

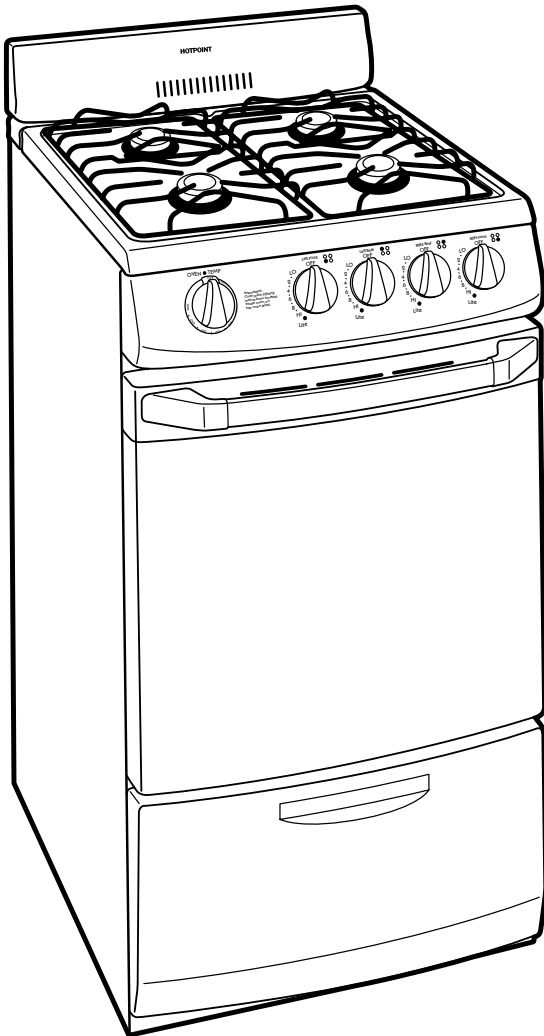

Features and Benefits

- All Purpose Burners - Deliver a wide range of heat output ideal for most cooking requirements
- Porcelain Oven Door - Offers a scratch-resistant porcelain coating for easy cleaning
- Lift-Up Cooktop - Cooktop lifts up for easy access to porcelain-enameled subtop
- Continuous Grates - Provide a flat, sturdy surface allowing easy movement of pans between burners
- Two Oven Racks - Feature a durable construction to help accommodate any size or type of cookware
- Four Embossed Rack Positions - Increase cooking flexibility and maximize oven capacity
- Broiler Drawer - Supplies a concentrated heat for crisping and browning
- Broiler Pan With Grid - Convenient broiler pan can be used when broiling for crisping and browning
- Model RGA720PKWH – White