

GE Monogram®

Use and Care Guide

Dishwasher

ZBD5600

ZBD5700

ZBD5900

Introduction

Your new Monogram dishwasher makes an eloquent statement of style, convenience and kitchen planning flexibility. Whether you chose it for its purity of design, practical features or assiduous attention to detail—or for all of these reasons—you’ll find that your Monogram dishwasher’s superior blend of form and function will delight you for years to come.

The information on the following pages will help you operate and maintain your dishwasher properly.

If you have any other questions—in the USA, please call the GE Answer Center® 800.626.2000. In Canada, please call 1.888.880.3030.

Or, visit our Website at: www.monogram.com

Contents

Appliance Registration	3, 27, 28	Optional Accessories	19
Care and Cleaning	15–18	Problem Solver	20–23
Consumer Services	3, 24	Safety Instructions	4–6
Model and Serial Number Location	3	USA Warranty	25
Operating Instructions	7–14	Canada Warranty	26
Control Panel and settings for ZBD5600	7, 8		
Control Panel and settings for ZBD5700 and ZBD5900	9–11		
Water Temperature	12		
Rinse Agent	12		
Detergents	12		
Dishwasher Racks	13, 14		

Consumer Information

Dishwasher

Before using your dishwasher

Read this guide carefully. It is intended to help you operate and maintain your new dishwasher properly.

Keep it handy for answers to your questions.

If you don't understand something or need more help, call in the USA:

GE Answer Center®,
800.626.2000,
24 hours a day, 7 days a week

In Canada, call 1.888.880.3030.

Or, visit our Website at: www.monogram.com

Write down the model & serial numbers

You can find the model and serial numbers at the inside left tub flange.

These numbers are also on the Consumer Product Ownership Registration Card packed separately with your dishwasher.

Before sending in this card, please write these numbers here:

Model Number

Serial Number

Use these numbers in any correspondence or service calls concerning your dishwasher.

If you received a damaged dishwasher

Immediately contact the dealer (or builder) that sold you the dishwasher.

Save time & money

Before you request service, check the Problem Solver in the back of this guide.

It lists causes of minor operating problems that you can correct yourself.

If you need service

To obtain service, see the Consumer Services page in the back of this guide.

We're proud of our service and want you to be pleased. If for some reason you are not happy with the service you receive, here are steps to follow for further help.

For customers in the USA:

FIRST, contact the people who serviced your appliance. Explain why you are not pleased. In most cases, this will solve the problem.

NEXT, if you are still not pleased, write all the details—including your phone number—to:

Manager, Customer Relations
GE Appliances
Appliance Park
Louisville, KY 40225

For customers in Canada:

FIRST, contact the people who serviced your appliance. Explain why you are not pleased. In most cases, this will solve the problem.

NEXT, if you are still not pleased, write all the details—including your phone number—to:

Manager, Consumer Relations
Camco Inc.
1 Factory Lane, Suite 310
Moncton, N.B. E1C 9M3

IMPORTANT SAFETY INSTRUCTIONS MESURES DE SÉCURITÉ IMPORTANTES

▲ **WARNING!**

For your safety, the information in this guide must be followed to minimize the risk of fire, explosion, electric shock, or to prevent property damage, personal injury, or loss of life.

- Do not tamper with controls.
- Do not abuse, sit on, or stand on the door or dish rack of the dishwasher.
- Do not discard a dishwasher without first removing the door of the washing compartment.
- Do not store or use combustible materials, gasoline or other flammable vapors and liquids in the vicinity of this or any other appliance.
- Do not allow children to play inside, on or with this appliance or any discarded appliance.

▲ **MISE EN GARDE!**

Pour votre sécurité, veuillez suivre à la lettre les directives données dans le présent guide afin de réduire les risques d'incendie, d'explosion ou de chocs électriques, et prévenir les dommages matériels et les blessures graves ou mortelles.

- Ne modifiez pas le fonctionnement des commandes.
- Ne montez pas ou ne vous assoyez pas sur la porte ou les paniers du lave-vaisselle, et ne les utilisez pas de façon abusive.
- Ne jetez pas un lave-vaisselle sans en avoir d'abord enlevé la porte.
- N'entreposez pas et n'utilisez pas d'essence, de vapeurs ou de liquides inflammables à proximité de cet appareil ou de tout autre électroménager.
- Ne laissez pas les enfants jouer avec le lave-vaisselle ni monter dessus. Ne les laissez pas s'introduire à l'intérieur de cet appareil ou d'un vieil appareil qui ne sert plus.

▲ **WATER HEATER SAFETY**

Under certain conditions hydrogen gas may be produced in a water heater that has not been used for two weeks or more. HYDROGEN GAS IS EXPLOSIVE.

If the hot water has not been used for two weeks or more, prevent the possibility of damage or injury by turning on all hot water faucets and allowing them to run for several minutes. Do this before using any electrical appliance which is connected to the hot water system. This simple procedure will allow any built-up hydrogen gas to escape. Since the gas is flammable, do not smoke or use an open flame or appliance during this process.

▲ **SÉCURITÉ DU CHAUFFE-EAU**

Dans certaines conditions, il peut se former de l'hydrogène à l'intérieur d'un chauffe-eau qui n'a pas servi pendant deux semaines ou plus. L'HYDROGÈNE EST UN GAZ EXPLOSIF.

Pour réduire les risques de dommages ou de blessures lorsque l'eau chaude n'a pas été utilisée depuis deux semaines ou plus, ouvrez tous les robinets d'eau chaude et laissez l'eau couler pendant plusieurs minutes avant d'utiliser un appareil électrique raccordé au système d'eau chaude. Vous éliminerez ainsi l'hydrogène qui pourrait s'y être accumulé. Puisqu'il s'agit d'un gaz inflammable, ne fumez pas ou n'utilisez pas une flamme nue au cours de ce processus.

PROPER INSTALLATION AND MAINTENANCE

This dishwasher must be properly installed and located in accordance with the Installation Instructions before it is used. If you did not receive an Installation Instructions sheet with your dishwasher, you can receive one by calling us toll-free in the USA, at the GE Answer Center®, 800.626.2000. In Canada, call 1.888.880.3030.

- Connect to a grounded metal, permanent wiring system; or run an equipment-grounding conductor with the circuit conductors and connect to the equipment-grounding terminal or lead of the appliance.
- Improper connection of the equipment-grounding conductor can result in a risk of electric shock. Check with a qualified electrician or service representative if you are in doubt whether the appliance is properly grounded.
- Dispose of discarded appliances and shipping or packing material properly.
- Do not attempt to repair or replace any part of your dishwasher unless it is specifically recommended in this manual. All other servicing should be referred to a qualified technician.
- To minimize the possibility of electric shock, disconnect this appliance from the power supply before attempting any maintenance. **NOTE:** Turning the dishwasher off does not disconnect the appliance from the power supply. We recommend having a qualified technician service your appliance.

INSTALLATION ET ENTRETIEN APPROPRIÉS

Avant de l'utiliser, vous devez installer correctement ce lave-vaisselle conformément aux directives d'installation fournies. Si vous n'avez pas reçu une feuille de directives d'installation avec votre lave-vaisselle, vous pouvez en obtenir un exemplaire en téléphonant sans frais au Centre de réponse GE des États-Unis au 1.800.626.2000. Au Canada, composez le 1.888.880.3030.

- Cet appareil doit être relié à un système de câblage électrique permanent, mis à la terre. Sinon, un fil de mise à la terre pour appareillage doit être installé et raccordé à la borne ou au fil de mise à la terre de l'appareil.
- Un raccordement non approprié du fil de mise à la terre pour appareillage peut présenter des risques de chocs électriques. Si vous doutez de la qualité de la mise à la terre de votre électroménager, consultez un représentant du Service après-vente ou un électricien qualifié.
- Jetez de la façon appropriée les vieux électroménagers, ainsi que le matériel d'emballage et d'expédition.
- Ne tentez pas de réparer ou de remplacer toute pièce de votre lave-vaisselle, à moins que cela ne soit spécifiquement recommandé dans le présent guide. Confiez toutes les autres réparations à un réparateur qualifié.
- Afin de réduire les risques de chocs électriques, débranchez toujours l'appareil avant de le réparer. **REMARQUE :** Lorsque vous mettez la commande du lave-vaisselle à OFF (arrêt), le courant qui alimente l'appareil n'est pas coupé. Nous vous recommandons de confier la réparation de votre appareil à un réparateur qualifié.

IMPORTANT SAFETY INSTRUCTIONS MESURES DE SÉCURITÉ IMPORTANTES

WHEN USING YOUR DISHWASHER

Use this appliance only for its intended purpose as described in this Owner's Guide.

- Use only powder, tabs or liquid detergents or wetting agents recommended for use in a dishwasher and keep them out of the reach of children.
- Locate sharp items so that they are not likely to damage the door seal.
- Load sharp knives with the handles up to reduce the risk of cut-type injuries.
- Do not wash plastic items unless marked *dishwasher safe* or the equivalent. For plastic items not so marked, check the manufacturer's recommendations.

- Non-Dishware Items: Do not wash items such as electronic air cleaner filters, furnace filters and paint brushes in your dishwasher. Damage to dishwasher and discoloration or staining of dishwasher may result.
- Do not touch the heating element during or immediately after use.
- Do not operate your dishwasher unless all enclosure panels are properly in place.
- Close supervision is necessary if this appliance is used by or near children.
- Load light plastic items so they will not become dislodged and drop to the bottom of the dishwasher—they might come into contact with the heating element and be damaged.

***READ AND FOLLOW THIS SAFETY
INFORMATION CAREFULLY.
SAVE THESE INSTRUCTIONS***

LORSQUE VOUS UTILISEZ VOTRE LAVE-VAISSELLE

N'utilisez ce lave-vaisselle que pour l'usage auquel il est destiné, comme expliqué dans le présent Guide d'utilisation.

- N'utilisez que des détergents liquides, en poudre ou en pastilles et les produits de rinçage recommandés pour lave-vaisselle. Gardez tous ces produits hors de portée des enfants.
- Placez les couteaux les poignées vers le haut afin de réduire les risques de coupures.
- Ne lavez pas d'articles en plastique dans le lave-vaisselle, à moins qu'ils portent la mention *lavable au lave-vaisselle* ou toute mention équivalente. Lorsque les articles de plastique ne portent aucune mention, lisez les recommandations du fabricant.

- Articles divers : Ne lavez pas des articles comme les filtres à air électroniques, les filtres de fournaise et les pinceaux dans votre lave-vaisselle. Ils pourraient endommager le lave-vaisselle et décolorer ou tacher la cuve.
- Ne touchez pas à l'élément chauffant pendant ou immédiatement après le lavage.
- Ne faites pas fonctionner votre lave-vaisselle lorsque l'un de ses panneaux est enlevé.
- Il faut exercer une étroite surveillance lorsque vous faites fonctionner le lave-vaisselle en présence d'enfants.
- Placez les articles légers en plastique de façon qu'ils ne bougent pas ou ne tombent au fond de l'appareil pendant le lavage. Ils pourraient être endommagés s'ils entrent en contact avec l'élément chauffant.

***VEUILLEZ LIRE ET SUIVRE À LA LETTRE
CES MESURES DE SÉCURITÉ.
CONSERVEZ CES DIRECTIVES***

You can locate your model number on the left inside of your dishwasher tub. Throughout this manual, features and appearance may vary from your model.

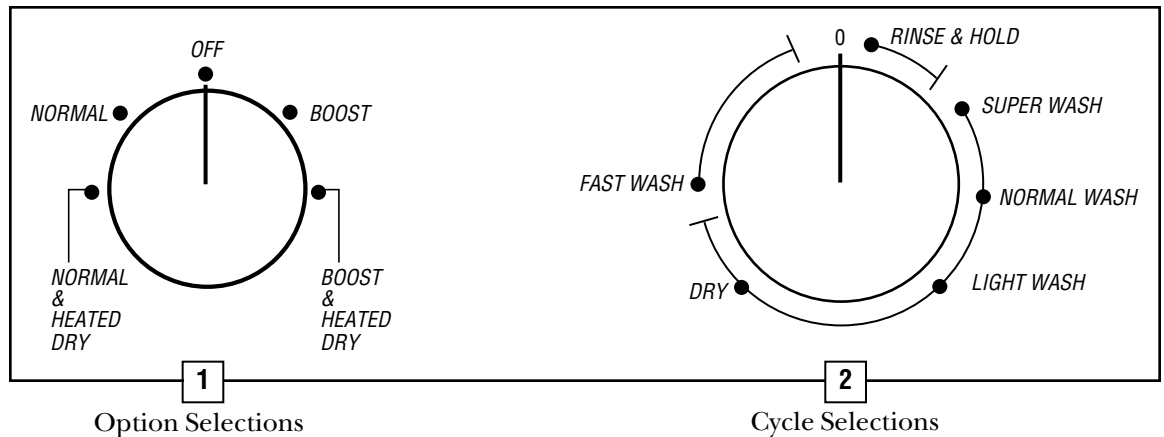

Control Settings

1. OPTION SELECTIONS—Turn the dial either way to select an option.

BOOST	Provides extra heat in the wash cycle to increase water temperature for best performance and is best used with heavily-soiled dishes. The timer will not advance past DRY. Dishes air dry naturally and energy is saved.
BOOST & HEATED DRY	Provides extra heat to increase water temperature for best performance and is best used with heavily-soiled dishes. Turns on the heater for fast drying. This cycle will extend the wash time by 21–38 minutes. NOTE: Cannot be selected with RINSE & HOLD or FAST WASH cycles.
NORMAL	Shuts off the drying heat option. The timer will not advance past DRY. Dishes air dry naturally and energy is saved.
NORMAL & HEATED DRY	Turns on the heater for fast drying. This cycle will extend the wash time by 16 minutes. NOTE: Cannot be selected with RINSE & HOLD or FAST WASH cycles.
OFF	To cancel a wash cycle during operation, turn this dial to the OFF position and turn the Cycle Selections dial to the end of the selected program. To interrupt/pause a wash cycle during operation, turn this dial to the OFF position. To restart, turn this dial to the desired option.

2. CYCLE SELECTIONS—Turn the dial clockwise to select cycle.

RINSE & HOLD	For rinsing partial loads that will be washed later. Do not use detergent with this cycle.
SUPER WASH	For heavily-soiled dishes or cookware with dried-on or baked-on soils. Everyday dishes may be included. This cycle will not remove burned-on foods.
NORMAL WASH	For loads of everyday dishes, glasses and cookware with medium soils.
LIGHT WASH	For lightly soiled everyday loads.
FAST WASH	For recently used, lightly soiled loads to be washed in a short time.

Start a wash load

Close the door until it locks in place and turn the Options Selections dial to the desired setting. Then turn the Cycle Selections dial to the desired setting to start the dishwasher. There is a time delay between start-up and water fill while the timer is advancing. Therefore you will not hear any wash action right away.

To interrupt/pause a wash cycle during operation, turn the Option Selections dial to the OFF position. To restart, turn this dial to the desired option.

⚠ CAUTION: Be careful when opening the door. The hot steam that escapes when the door is opened during a cycle may cause injuries. Stand back as you open the door and allow the steam to escape.

⚠ ATTENTION : Faites attention lorsque vous ouvrez la porte. La vapeur brûlante qui s'échappe lorsque vous ouvrez la porte pendant un programme de lavage peut causer des brûlures. Lorsque vous ouvrez la porte, reculez et laissez la vapeur s'échapper de l'appareil.

What happens in each cycle based on the NORMAL Option Selection at 120° F. inlet water temperature

Cycles	Water Use Gallons (approx.)	Cycle Time Minutes (approx.)	Cycle Sequence
RINSE & HOLD	1.7	10	Rinse
SUPER WASH	8.4	76	Pre-Wash Pre-Wash Main Wash Rinse Rinse
NORMAL WASH	6.7	70	Pre-Wash Main Wash Rinse Rinse
LIGHT WASH	5.0	67	Main Wash Rinse Rinse
FAST WASH	5.0	28	Pre-Wash Main Wash Rinse

Times for Optional Selections:

HEATED DRY = 16 minutes

BOOST = 5–22 minutes, depending upon inlet water temperature and wash load selection.

Detergent Usage Guide (Powder or Liquid)

CYCLES	SOFT WATER 0–3 grains		MEDIUM WATER 3–7 grains		HARD WATER 7–12 grains*	
	Main Cup	Open Cup	Main Cup	Open Cup	Main Cup	Open Cup
SUPER WASH	Full	None	Full	Full	Full	Full
NORMAL WASH	½ Full	None	Full	None	Full	Full
LIGHT WASH	½ Full	None	Full	None	Full	None
FAST WASH	½ Full	None	½ Full	None	Full	Full
RINSE & HOLD	Use no detergent		Use no detergent		Use no detergent	

*12 grains and up is extremely hard water. A water softener is recommended. Without it, lime can build up in the water valve. The water valve may stick and flooding could occur.

NOTE: The above chart is a general guide. Detergent amounts should be adjusted depending on the amount and type of soil until satisfactory results are achieved.

You can locate your model number on the left inside of your dishwasher tub. Throughout this manual, features and appearance may vary from your model.

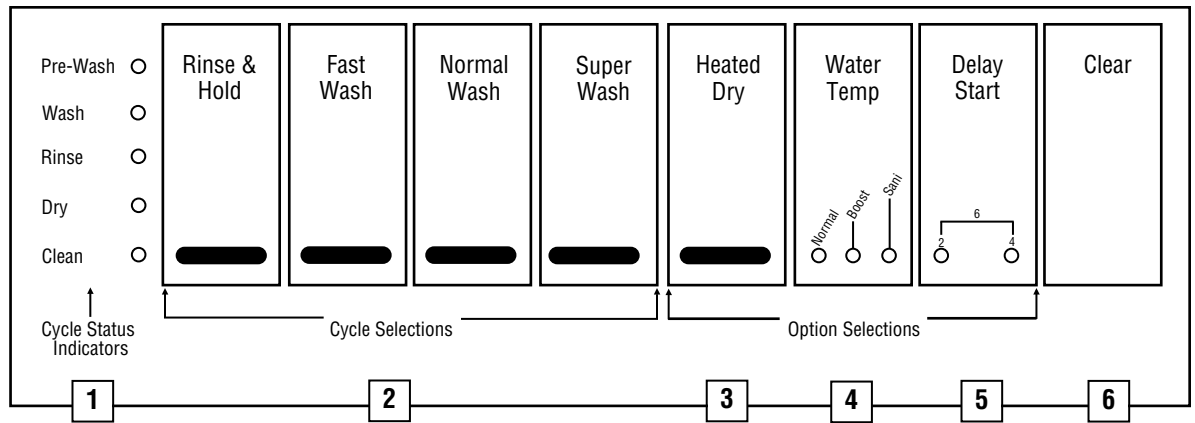

Cycle Status Indicators

At the start of a cycle all Cycle Status Indicators relevant to that program are illuminated. As the program progresses, each Cycle Status Indicator switches off to show what stage of your wash has finished. Your wash is complete when the CLEAN light is illuminated.

All of the Cycle Status Indicators will flash on and off if either the door is opened during a cycle or if the cycle has been paused.

Control Settings

1. Cycle Status Indicators—This display tells you what is happening while the dishwasher is in operation.

PRE-WASH	Displayed until the pre-wash periods are complete.
WASH	Displayed until the main wash period is complete.
RINSE	Displayed until rinse periods are complete.
DRY	Displayed until dry period is complete (if HEATED DRY is selected).
CLEAN	Displayed when cycle is complete. Light remains <i>ON</i> until the door is opened.

2. Cycle Selections—Press desired cycle button, you will hear a beep and the light under the button will come *ON* indicating your selection. You may change this selection by pressing the button of the new wash cycle within 15 seconds.

RINSE & HOLD	For rinsing partial loads that will be washed later. Do not use detergent with this cycle.
FAST WASH	For recently used, lightly soiled loads to be washed in a short time.
NORMAL WASH	For loads of everyday dishes, glasses and cookware with medium soils. NOTE: For heavily soiled dishes, choose NORMAL WASH plus WATER TEMP BOOST.
SUPER WASH	For heavily-soiled dishes or cookware with dried-on or baked-on soils. Everyday dishes may be included. This cycle may not remove burned-on foods.

3. HEATED DRY—When selected, turns the drying heater on for fast drying. This will extend the time to your wash cycle. When this is *NOT* selected, the dishes air dry naturally and energy is saved. HEATED DRY is not available on RINSE & HOLD.

4. WATER TEMP—This option provides extra heat to increase water temperature for best performance. It is used best with heavily-soiled dishes. This option cannot be used with RINSE & HOLD.

NORMAL—This is the default setting—wash and rinse water temperatures up to 149°F.

BOOST—This water temp selection provides a wash and rinse with water temperatures up to 158°F.

SANI—This water temp selection provides a sanitizing wash and rinse with water temperatures up to 171°F.

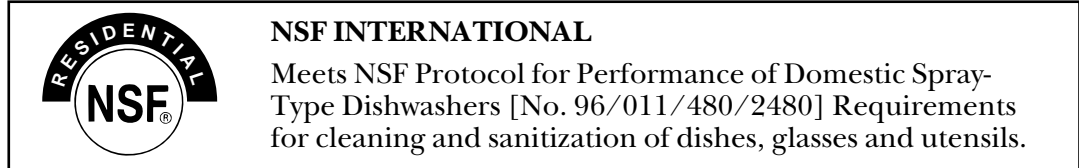

5. DELAY START—This option will allow you to delay the start time of any wash cycle except RINSE & HOLD for up to 6 hours.

1. Select the delay start you want by pressing the DELAY START button. Multiple pressing will alternate the delay time between 2, 4 or 6 hours and OFF.
2. Select the wash cycle you want. The DELAY START light/lights will flash to indicate time selected.
3. The flashing Cycle Status Indicators show how many hours will elapse before washing begins.

6. CLEAR—If you wish to change the wash cycle after it has started or wish to turn the dishwasher off before the wash finishes, it's simple. First pause the dishwasher by pressing the selected Cycle Selection button, then press the CLEAR button. The dishwasher will then drain. You can now select a new wash cycle if you want. If you don't, the dishwasher will drain and all Cycle Status Indicators will go out. If you have selected a new wash cycle, remember to add more detergent to the detergent compartment if required.

Start a wash load

To start the dishwasher, close the door until it locks in place, push the desired Cycle Selection button, and then select the desired Option buttons. There is a time delay between start-up and water fill so you will not hear any wash action right away.

The door must be closed and latched into place to select a CYCLE Selection or an option.

If the door is opened during a cycle and left open, the dishwasher will beep once every minute until the door is closed and latched into place.

To interrupt/pause a cycle, press the selected cycle button. The Status Indicators will flash.

⚠ CAUTION: Be careful when opening the door; the hot steam that escapes when the door is opened may cause injuries. Stand back as you open the door and allow the steam to escape.

⚠ ATTENTION : Faites attention lorsque vous ouvrez la porte. La vapeur brûlante qui s'échappe lorsque vous ouvrez la porte pendant un programme de lavage peut causer des brûlures. Lorsque vous ouvrez la porte, reculez et laissez la vapeur s'échapper de l'appareil.

To restart the wash process, close the door until it locks in place. Re-press the cycle button. There may be a time delay of up to a few minutes because the water temperature needs to stabilize before it starts the wash cycle. During this time the DRY light will be on.

Tone Silencing

You can prevent the beep from sounding when selecting control settings.

1. Press the CLEAR and FAST WASH buttons together prior to selecting settings.
2. To have sound again, simply press the CLEAR and FAST WASH buttons together again.

Dishwasher

Auto Memory

Your dishwasher has the ability to remember what options you like with any particular wash cycle. This means that if you select NORMAL WASH your dishwasher will automatically select the options that you selected last time you washed with the NORMAL WASH cycle. This memory function works with NORMAL WASH and SUPER cycles. You can change the options that have been remembered with a particular wash cycle if you require.

NOTE: Pressing the CLEAR button at the end of a wash cycle does not interfere with this automatic memory function.

Child Lockout Mode

To reduce the possibility of children starting the dishwasher when unattended, a child lockout feature can be enabled. Once enabled, each button must be pressed and held for two seconds until you hear a BEEP, before the dishwasher will respond.

This feature can be enabled by pressing both the CLEAR and RINSE & HOLD buttons together and holding both for two seconds. You will hear three BEEPS when the child lockout is enabled.

The child lockout can be cancelled by pressing the CLEAR and RINSE & HOLD together and holding both pressed for two seconds until a single BEEP is heard.

NOTE: Child lockout overrides tone silencing.

What happens in each cycle based on the NORMAL WATER TEMP Option Selection at 120° F. inlet water temperature

Cycles	Water Use Gallons (approx.)	Cycle Time Minutes (approx.)	Cycle Sequence
RINSE & HOLD	1.7	8	Rinse
FAST WASH	6.1	49	Pre-Wash Main Wash Rinse
NORMAL WASH	6.7	75	Pre-Wash Main Wash Rinse Rinse
SUPER WASH	8.4	106	Pre-Wash Main Wash Rinse Rinse Rinse

Additional Times for Optional Selections:

HEATED DRY = 11 minutes

WATER TEMP–BOOST = 6–51 minutes

WATER TEMP–SANI = 23–57 minutes

Detergent Usage Guide (Powder or Liquid)

CYCLES	SOFT WATER 0–3 grains		MEDIUM WATER 3–7 grains		HARD WATER 7–12 grains*	
	Main Cup	Open Cup	Main Cup	Open Cup	Main Cup	Open Cup
SUPER WASH	Full	None	Full	Full	Full	Full
NORMAL WASH	½ Full	None	Full	None	Full	Full
FAST WASH	½ Full	None	Full	None	Full	Full
RINSE & HOLD	Use no detergent		Use no detergent		Use no detergent	

*12 grains and up is extremely hard water. A water softener is recommended. Without it, lime can build up in the water valve. The water valve may stick and flooding could occur.

NOTE: The above chart is a general guide. Detergent amounts should be adjusted depending on the amount and type of soil until satisfactory results are achieved.

Using the dishwasher

Dishwasher

Water Temperature

The entering water must be at least 120°F. and not more than 150°F., for effective cleaning and to prevent dish damage. Check the water temperature with a candy or meat thermometer.

Turn on the hot water faucet nearest the dishwasher, place the thermometer in a glass and let the water run continuously into the glass until the temperature stops rising.

Use a Rinse Agent

A rinse agent improves dry performance, removes spots and prevents new film build-up on your dishes, glasses, flatware, cookware and plastic.

Fill the rinse agent chamber by rotating the round cap counterclockwise and remove. Fill chamber to maximum level. Replace and lock the cap into place.

To check if rinse agent is needed: a solid black indicator indicates sufficient rinse agent; a clear indicator indicates a low level and requires adding more rinse agent.

• A full dispenser should last about one month.

- If rinse agent spills, wipe it up immediately. It can keep your detergent from working.
- If after washing you notice cloudy spots, streaks or water marks on the glassware, and the rinse agent dispenser is not empty, it may be necessary to increase the dispenser settings. To do so, remove the cap and using a butter knife, rotate the indicator arrow to a higher number. Replace the cap when done.
- If glasses appear smeared or there is foam present on the bottom of the glasses or the bottom of the machine, select a lower dosage number.

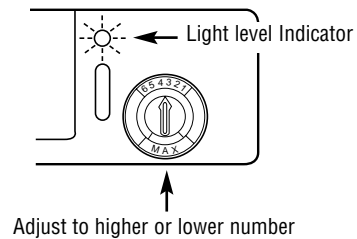
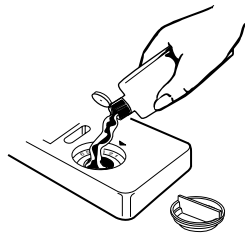

Detergents

Use only detergent specifically made for use in dishwashers. Keep your detergent fresh and dry. Don't put powder detergent into the dispenser until you're ready to wash dishes.

The amount of detergent to use depends on whether your water is hard or soft. With hard water, you need extra detergent. With soft water, you need less detergent.

Protect your dishes and dishwasher by contacting your water department and asking how hard your water is. Twelve or more grains is extremely hard water. A water softener is recommended. Without it, lime can build up in the water valve, which could stick while open and cause flooding. Too much detergent with soft water can cause a permanent cloudiness of glassware, called etching.

To open the detergent compartment, push the lever latch inward.

You'll find two detergent dispensers on the inside door of your dishwasher. All wash cycles require detergent in the main cup. Some wash cycles require the use of the open cup. When using automatic dishwashing detergent tabs, place one tab in the main cup and close.

Be sure the Cycle Status Indicators (on some models) are not lit before adding detergent. Otherwise, the detergent cup will not close and latch properly. Add detergent then close the main cup.

NOTE: To open detergent cup after it has been closed, push the lever latch inward.

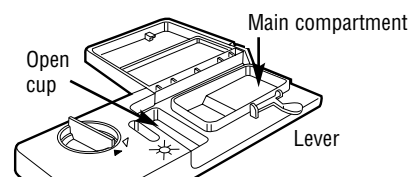

Loading the Racks

Dishwasher

Upper Rack

The upper rack is for glasses, cups and saucers. Cups and glasses fit best along the sides. This is also a secure place for dishwasher-safe plastics.

The cup shelf may be placed in the up or down position to add flexibility. The cup shelf can also secure wine glasses at an angle for best washability. Because wine glasses come in various sizes, after loading, slowly push in the rack to make sure they will clear the top of the dishwasher.

The upper rack is also fitted with an adjustable glass support wire which can be positioned to secure tall glasses or fold down to fit larger items over it. You may need to change the height of the upper rack, depending on how tall your load is.

The upper rack is good for all kinds of oddly-shaped utensils. Saucepans, mixing bowls and other items should be placed face down.

Secure larger dishwasher-safe plastic items over two fingers when possible.

Make sure small plastic items are secure so they can't fall onto the heating element.

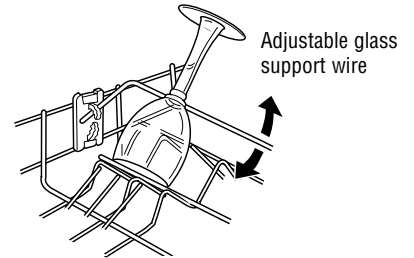
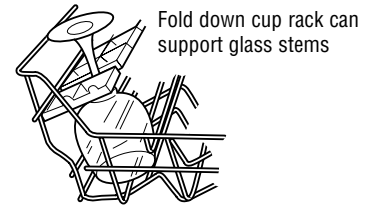
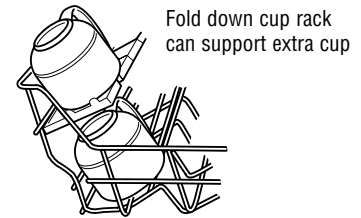

Adjusting Upper Rack Height

The upper rack can be raised or lowered to provide extra room for different sized items. Empty the upper rack. Remove the rail pegs in the front of the rack runners by squeezing and lifting the top of the peg, then slide the rack out.

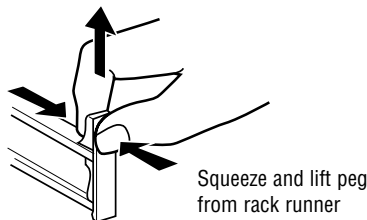

Re-insert the rack in the chosen position and replace the pegs. Check that the spray arm is free to rotate.

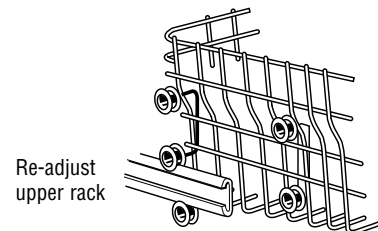

Upper Wash Tower

Take care not to obstruct the rotation of the spray arm under the upper rack or cover the water collector in the center of the upper rack.

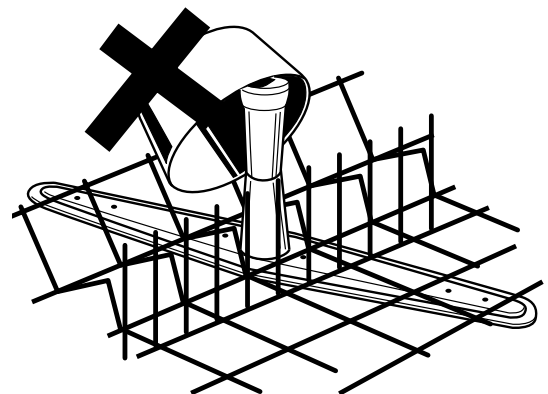

Loading the Racks

Dishwasher

Features and appearance of racks and silverware baskets may vary from your model.

Silverware Basket

Put flatware in the removable basket with fork and knife handles up to protect your hands. Place spoons in the basket with handles down. Mix knives, forks and spoons so they don't nest together. Distribute evenly. Small plastic items, such as measuring spoons and lids from small containers, should go in the bottom of the silverware basket with silverware on top.

Flip down covers can be lowered to secure lightweight items from the effects of the vigorous wash action. The slots in the covers can be used to separate silverware.

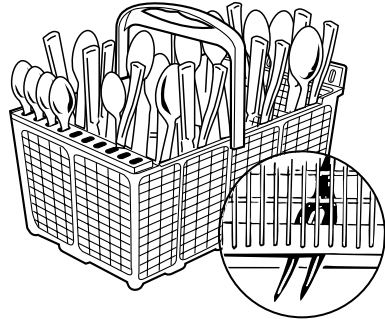

Don't let any item extend through bottom

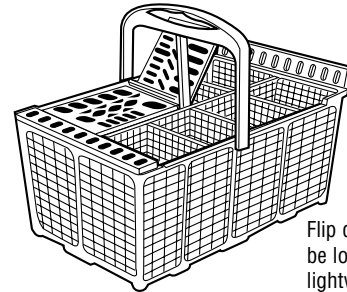

Flip down covers can be lowered to secure lightweight items

Lower Rack

When loading the lower rack, do not load large platters or trays in the front left corner. They may prevent detergent from circulating during the wash cycle.

The lower rack is best used for plates, saucers, and cookware. Large items such as broiler pans and racks should go along the sides. Load platters, pots and bowls along the sides, in corners, or in the back. The soiled side of items should face the center of the rack.

Fold-down fingers provide flexibility for extra large and hard-to-fit items.

The fingers may be left in the up position or folded down to customize the lower rack.

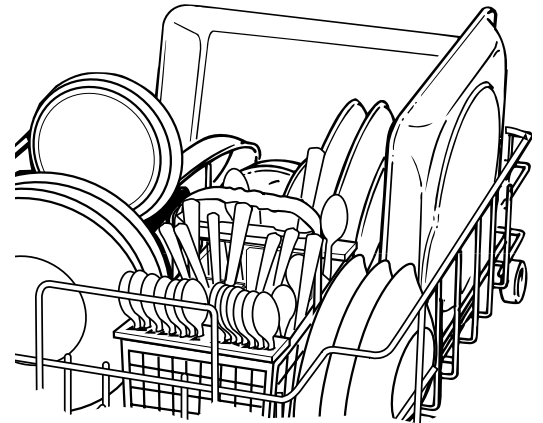

Follow these guidelines for loading 10 place settings

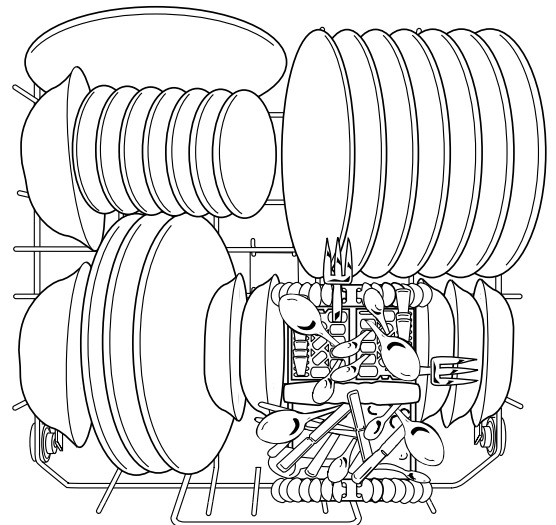
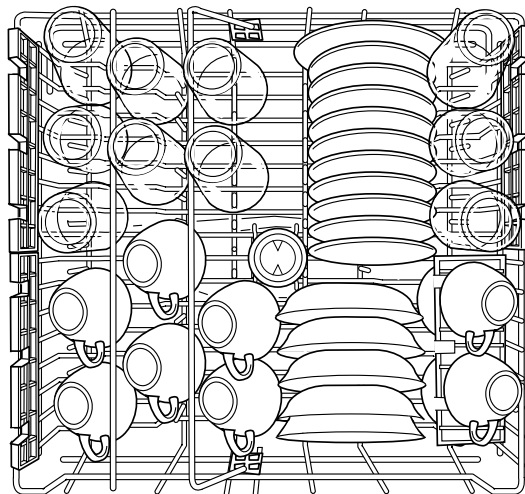

Care and Cleaning

Dishwasher

Exterior

To clean the control panel use a lightly dampened cloth then dry thoroughly. To clean the exterior painted panels use a good appliance polish wax.

Never use sharp objects, scouring pads or harsh cleaners on any part of the dishwasher.

Use stainless steel cleaner on stainless steel panel. You can order Stainless Steel Magic # WX10X15 through GE Parts in the USA, by calling 800.626.2002. In Canada, call 1.888.880.3030.

Interior

The stainless steel tub can be cleaned with Stainless Steel Magic or a similar product using a clean, soft cloth.

Wipe the rubber door seals occasionally, including the seal at the bottom of the door.

Use stainless steel cleaner on stainless steel panel. You can order Stainless Steel Magic # WX10X15 through GE Parts in the USA, by calling 800.626.2002. In Canada, call 1.888.880.3030.

Protect Against Freezing

If your dishwasher is left in an unheated place during the winter, ask a service technician to:

1. Cut off electrical power to the dishwasher. Remove fuses or trip circuit breaker.
 2. Turn off the water supply and disconnect the water inlet line from the water valve.
 3. Drain water from the water inlet line and water valve. (Use a pan to catch the water.)
 4. Reconnect the water inlet line to the water valve.
 5. Remove the filters from the tub bottom and use a sponge to soak up water.
-

The Air Gap

An air gap protects your dishwasher against water backing up into it if a drain clogs. The air gap is not a part of the dishwasher. It is not covered by your warranty. Not all plumbing codes require air gaps, so you may not have one.

The air gap is easy to clean.

1. Turn off the dishwasher and lift off the chrome cover.
2. Unscrew the plastic cap and clean with a toothpick.

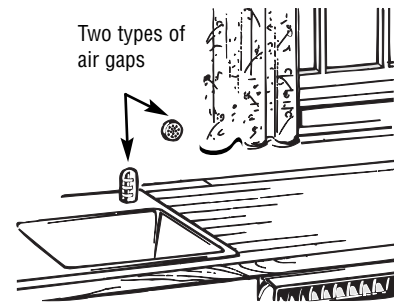

Check the air gap any time your dishwasher isn't draining well.

Removing and Cleaning the Spray Arms and Glass Trap

Periodically, remove and clean the spray arms to make sure that none of the nozzles have become blocked.

To remove the lower spray arm, grasp the center of the spray arm and pull upwards, it will unclip. When replacing, make sure the spray arm is fully seated.

The plastic cone on the underside of the spray arm can be detached by unscrewing it counterclockwise.

To remove the upper spray arm, carefully unscrew the spray arm from the plastic tower. To achieve this, hold the inner tower steady and unscrew the spray arm clockwise. To replace the spray arm, carefully screw the spray arm counterclockwise onto the inner tower.

To clean the upper and lower spray arms, rinse them under running water and make sure spray nozzles are clear.

The glass trap is located in the stainless steel filter at the base of your dishwasher. The glass trap is used to collect larger food items and other foreign objects, which may be too big to pass through the drain pump. For best wash performance, check the glass trap occasionally.

To remove the glass trap, twist counterclockwise, rotate the glass trap and lift. **To clean the glass trap,** empty and rinse thoroughly. **To replace,** reverse these steps making sure the glass trap locks into place.

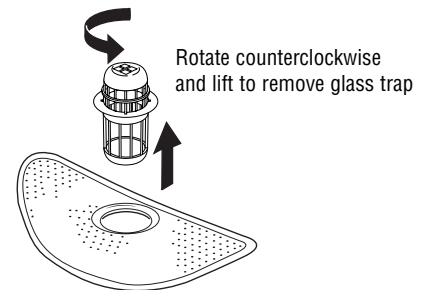
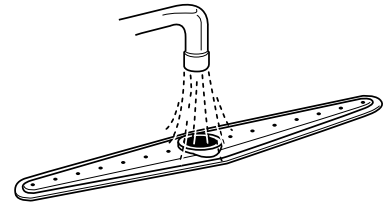
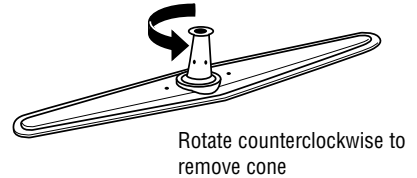
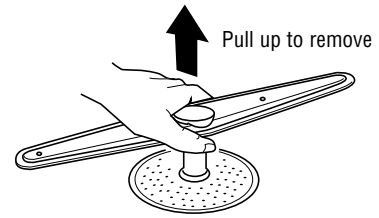

The Wash Filters

In addition to the glass trap, your dishwasher has three fine filters—

- a two piece round perforated stainless steel filter located in the base of the dishwasher.
- a finer micro-mesh filter located under the stainless steel filter.
- a super fine filter located below the lower spray arm.

Remove the stainless steel filter by first twisting and removing the glass trap. Lift out the stainless steel filter.

Attached to the underside of this filter is the micro-mesh filter. **To remove the micro-mesh filter**, squeeze the two clips above the stainless steel filter to release the micro-mesh.

To remove the super fine filter, remove the lower spray arm. Grasp the super fine filter around the outer edges. Remove by pulling upwards, it will unclip. Unscrew the tower counterclockwise. The right half of the stainless steel filter can now be removed.

To clean filters, place under running water and gently brush with a soft bristled brush. Be careful not to deform filters while cleaning, as this may prevent them from being properly re-installed.

The super fine filter is self-cleaning, there is no need to clean it. This filter need only be removed if you want to remove the right half of the stainless steel filter.

Replace your filters in the reverse order, starting with the right half of the stainless steel filter. Then screw in the tower. Replace the super fine filter over the tower by pressing firmly on the outer edge until it clips into place and reposition the lower spray arm. Reconnect the micro-mesh filter to the left half of the stainless steel filter prior to replacing it back into the dishwasher. Then replace the glass trap. Ensure that all filters are replaced correctly for best results.

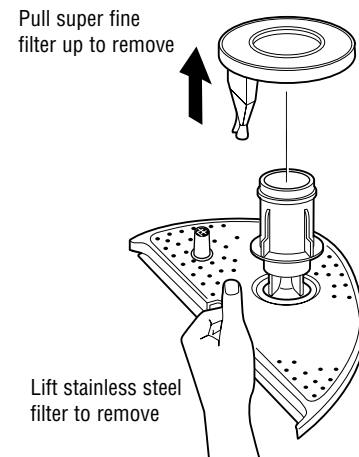
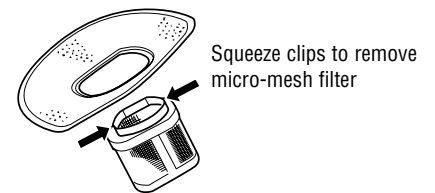
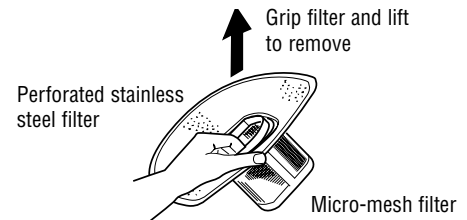

Light Bulb Replacement (on some models)

The interior light bulb is located in the rear top right corner.

To replace—

1. Make sure the dishwasher is disconnected from the power supply.
2. Unscrew the plastic lens counterclockwise.
3. Remove the bulb and replace with a maximum 15 watt bayonet bulb no larger than 1" in diameter and 2" long. Order part # WD21X10055.
4. Make sure the seal is correctly fitted to the plastic lens and screw it firmly into place.

⚠ CAUTION: The plastic lens must be secured before reconnecting power to the dishwasher.

⚠ ATTENTION : Il faut remettre la lentille de plastique en place avant de rétablir le courant au lave-vaisselle.

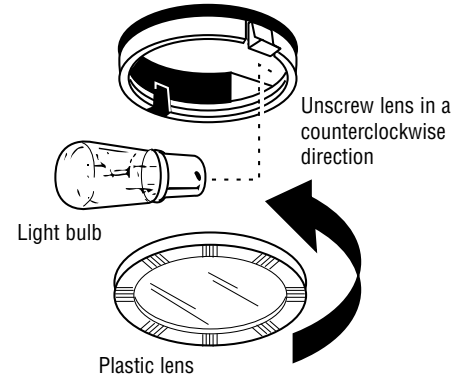

Water fill level

For best performance, check the water fill level of your dishwasher.

Once the dishwasher is fully connected, run it through a complete RINSE & HOLD cycle to ensure it is emptying and filling correctly. For low water pressure situations run the RINSE & HOLD cycle 3 times. Half way through the final RINSE & HOLD cycle, pause the dishwasher and check the water level inside the dishwasher. If the water level is not above the minimum water level (marked on the lower spray support tower), increase the fill level.

For Model ZBD5600—Remove the front kickplate and change the Fill Time switch setting.

For Model ZBD5700 and ZBD5900—

1. Ensure the dishwasher is not running through a cycle. Depress the WATER TEMP button for ten seconds until the second buzzer sounds.
2. Press the CLEAR button to select fill time, as per chart (80 seconds is the factory setting).
3. To test time, press DELAY START. The dishwasher will start filling. Listen for the dishwasher to complete filling. Once filled, the fill level must be checked to ensure fill time is correct.
4. Once complete, press the WATER TEMP button to exit fill time mode.

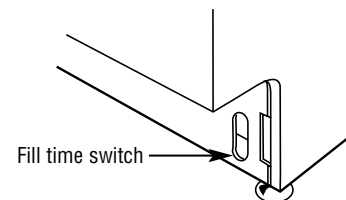
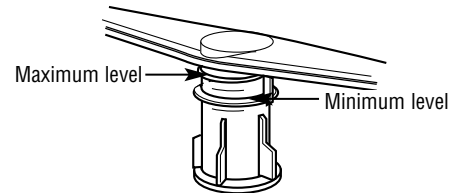

Continue to press the CLEAR button until the desired indicator is illuminated.

Cycle Status Indicators	Fill time
PRE-WASH	75 seconds
WASH	80 seconds
RINSE	90 seconds
DRY	100 seconds
CLEAN	110 seconds

Optional Accessories

Dishwasher

Change the Dishwasher's Appearance for ZBD5600 and ZBD5700 only

You can change the door panel appearance of your dishwasher by ordering one of these optional accessories:

- 1/4" Wood Panel Trim Kit
ZPF25B (Black)
ZPF25W (White)
- 3/4" Trimless Panel Kit
ZPF75B (Black)
ZPF75W (White)

These accessories are available at extra cost by calling in the USA, 800.626.2002. In Canada, call 1.888.880.3030.

Specify accessory number when ordering.

Before You Call For Service

Dishwasher

*Questions?
Use this
problem
solver*

PROBLEM	POSSIBLE CAUSE	WHAT TO DO
Cycle Status Indicators (on some models) go off when you're setting	Time too long between button selection	<ul style="list-style-type: none"> • Each button must be touched within 15 seconds after touching another control.
Unusual noises	Some of the sounds you will hear are normal <ul style="list-style-type: none"> • Timer advancing as cycle progresses. • Detergent cup opening. • Water draining out of the tub immediately after you touch a button. 	
	Utensils are not secure in the rack or something small has dropped into the rack	<ul style="list-style-type: none"> • Make sure everything is secured in dishwasher.
Detergent left in dispenser cups	Dishes are blocking the detergent cups	<ul style="list-style-type: none"> • Reposition the dishes.
Water won't pump out of the tub	Drain is clogged	<ul style="list-style-type: none"> • If you have an air gap, clean it. • Check to see if your kitchen sink is draining well. If not, you may need a plumber. • If the dishwasher drains into a disposer, run disposer clear.
Suds in the tub	Correct detergent wasn't used	<ul style="list-style-type: none"> • Use only automatic dishwasher detergents to avoid sudsing. • To remove suds from the tub, open the dishwasher and let suds evaporate. Add 1 gallon of cold water to the tub. Close the door until it locks into place. On models ZBD5700 and ZBD5900, pump out water by pressing the NORMAL WASH button. Wait one minute and press NORMAL WASH again, then press CLEAR. Repeat if necessary. On model ZBD5600, turn the Cycle Selection dial to NORMAL WASH. Wait one minute. Allow water to pump out. Repeat if necessary.
	Too much rinse agent used	<ul style="list-style-type: none"> • See the Rinse Agent section.
Dishes and flatware not clean	Inlet water temperature is below 120°F.	<ul style="list-style-type: none"> • Raise the water heater temperature to 120°F. • Depending on model, use WATER TEMP BOOST or WATER TEMP SANI option.
	Water pressure is temporarily low	<ul style="list-style-type: none"> • Turn on a faucet. Is water coming out more slowly than usual? If so, wait until pressure is normal before using your dishwasher.
	Air gap is clogged	<ul style="list-style-type: none"> • Clean the air gap.
	Improper rack loading	<ul style="list-style-type: none"> • Make sure large dishware does not block the detergent dispenser or the wash arm.

Questions?
Use this
problem
solver

PROBLEM	POSSIBLE CAUSE	WHAT TO DO
Spots and filming on glasses and flatware	Extremely hard water	· Use a rinse agent to remove spots and prevent new film build-up.
	Low inlet water temperature	· To remove stubborn spots from glassware:
	Overloading the dishwasher	1 Remove all metal utensils from the dishwasher.
	Improper loading	2 Do not add detergent.
	Old or damp powder detergent	3 Select the NORMAL WASH cycle and HEATED DRY option.
	Rinse agent dispenser empty	4 Start the dishwasher and allow to run until the main wash.
	Too little detergent	5 Open the door and pour 2 cups (500 ml) of white vinegar into the bottom of the dishwasher. 6 Close the door and allow to complete the cycle. If vinegar rinse doesn't work: Repeat as above, except use 1/4 cup (60 ml) of citric acid crystals instead of vinegar.
Cloudiness on glassware	Combination of soft water and too much detergent	· This is called etching and is permanent. To prevent this from happening, use less detergent if you have soft water. Wash glassware in the shortest cycle that will get them clean.
	Extended exposure to high temperature water	· Lower the water heater temperature.
Black or gray marks on dishes	Aluminum utensils have rubbed against dishes	· Remove marks with a mild, abrasive cleaner.
Dishes don't dry	Low inlet water temperature	· Make sure inlet water temperature is correct. · Depending on your model select WATER TEMP BOOST & HEATED DRY or WATER TEMP SANI and HEATED DRY options.
	Rinse agent dispenser is empty	· Check the rinse agent dispenser.
Dishwasher won't run	Fuse is blown, or the circuit breaker tripped	· Replace fuse or reset circuit breaker. Remove any other appliances from the circuit. · Try resetting.

Before You Call For Service

Dishwasher

*Questions?
Use this
problem
solver*

PROBLEM	POSSIBLE CAUSE	WHAT TO DO
Dishwasher won't start	Door not properly closed	•Press door until it clicks shut.
	Power supply not connected.	•Check dishwasher is plugged in and switch is on.
	Child Lockout mode is selected	•Press and hold desired button for two seconds. See Child Lockout mode section for models ZBD5700 and ZBD5900.
	Door opened during cycle when water is hot	•Relatch door. Wait a few minutes, dishwasher will restart automatically.
	Timer not set to start of wash cycle	•Turn to Cycle Selection starting position and Option dial to desired position.
All Cycle Status Indicators flashing or beeping every 30 seconds (on models ZBD5700 and ZBD5900)	Dishwasher is paused	•To restart the wash, press the selected wash button.
	Door not properly closed	•Press door until it clicks shut.
Flashing SUPER WASH light (on models ZBD5700 and ZBD5900)	Inlet water temperature is greater than 175°F.	•Reduce hot water inlet temperature to below 150°F.
Motor starts but water doesn't enter dishwasher (Flashing FAST WASH) (on models ZBD5700 and ZBD5900)	Water supply valve turned off	•Check water supply valve.
Program taking too long or not advancing properly (Flashing NORMAL WASH light) (on models ZBD5700 and ZBD5900)	Low inlet water temperature	•Allow time to heat water (up to one hour). •Check inlet water temperature. •Connect to hot water supply.
Water does not empty out of dishwasher (Flashing RINSE light) (on models ZBD5700 and ZBD5900)	Outlet blocked	•Check outlet hose for kinks and sharp bends. •Check and clean the drain pump filter. •Check sink trap, garbage disposal and air gap for blockage.
Dishwasher continues to drain (Flashing temp light) (on models ZBD5700 and ZBD5900)	Incorrect fill level or fill time	•Check fill level. See Water Fill Level section. •Call for service.
Yellow color on dishes and glassware	Water has iron or other mineral content	•A special filter in the water supply line is the only way to correct this problem. Contact a water softener company.

Questions?

*Use this
problem
solver*

PROBLEM	POSSIBLE CAUSE	WHAT TO DO
White film on glasses, tea and coffee stains	Hard water	· Try progressively increasing the Rinse Aid setting to 6. See the Rinse Agent section.
	Repeated use of Sani option	· Discontinue use of Sani option.
Brown spots or pitting of stainless steel and tarnishing of silver	Consistently low water level in dishwasher	· Check operating water level is between the MIN. and MAX. indicators on lower spray arm support tower. See Care and Cleaning section.
	Electrolysis following contact with other metals	· Wash scratched or worn pieces by hand. Polish silverware with a silver-plate cleaner.
	Detergent thrown over the cutlery or saucepans	· Load detergent properly. See Using the Dishwasher section.

With the purchase of your new Monogram appliance, receive the assurance that if you ever need information or assistance from GE, we'll be there. All you have to do is call—toll-free!

GE Answer Center®

***In the USA:
800.626.2000***

Whatever your question about any Monogram major appliance, GE Answer Center® information service is available to help. Your call—and your question—will be answered promptly and courteously. And you can call any time. GE Answer Center® service is open 24 hours a day, 7 days a week.

In Canada, call 1.888.880.3030.

In-Home Repair Service

***In the USA:
800.444.1845***

***In Canada:
1.888.880.3030***

A GE consumer service professional will provide expert repair service, scheduled at a time that's convenient for you. Many GE Consumer Service company-operated locations offer you service today or tomorrow, or at your convenience (7:00 a.m. to 7:00 p.m. weekdays, 9:00 a.m. to 2:00 p.m. Saturdays). Our factory-trained technicians know your appliance inside and out—so most repairs can be handled in just one visit.

For Customers With Special Needs...

***In the USA:
800.626.2000***

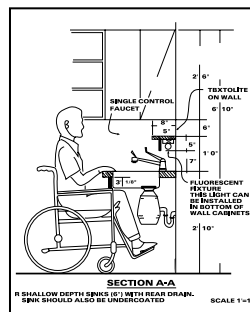

GE offers Braille controls for a variety of GE appliances, and a brochure to assist in planning a barrier-free kitchen for persons with limited mobility.

Consumers with impaired hearing or speech who have access to a TDD or a conventional teletypewriter may call 800.TDD.GEAC (800.833.4322) to request information or service.

Service Contracts

***In the USA:
800.626.2224***

***In Canada:
1.888.880.3030***

You can have the secure feeling that GE Consumer Service will still be there after your warranty expires. Purchase a GE contract while your warranty is still in effect and you'll receive a substantial discount. With a multiple-year contract, you're assured of future service at today's prices.

Parts and Accessories

***In the USA:
800.626.2002***

***In Canada:
1.888.880.3030***

Individuals qualified to service their own appliances can have parts or accessories sent directly to their home. The GE parts system provides access to over 47,000 parts...and all GE Genuine Renewal Parts are fully warranted.

User maintenance instructions contained in this guide cover procedures intended to be performed by any user. Other servicing generally should be referred to qualified service personnel. Caution must be exercised, since improper servicing may cause unsafe operation.

YOUR MONOGRAM DISHWASHER WARRANTY

Staple sales slip or cancelled check here. Proof of original purchase date is needed to obtain service under warranty.

WHAT IS COVERED

From the Date of the Original Purchase

ONE-YEAR

Any part of the dishwasher which fails due to a defect in materials or workmanship. During this full one-year warranty, GE will also provide, free of charge, all labor and in-home service to replace the defective part.

Second Year

Any part of the dishwasher which fails due to a defect in materials or workmanship. During this second-year limited warranty, you will be responsible for any labor or in-home service costs.

Five Years

The dishwasher rack, if it should rust, or the electronic control module if it should fail due to a defect in materials or workmanship. During this five-year limited warranty, you will be responsible for any labor or in-home service costs.

Lifetime

The stainless steel tub or door liner, if it fails to contain water due to a defect in materials or workmanship. During this full lifetime warranty, GE will also provide, free of charge, all labor and in-home service to replace the defective part.



This warranty is extended to the original purchaser and any succeeding owner for products purchased for ordinary home use in the 48 mainland states, Alaska, Hawaii and Washington, D.C. Proof of original purchase date is needed to obtain service under the warranty.

All warranty service will be provided by our Factory Service Centers or by our authorized Customer Care® servicers during normal working hours.

Should your appliance need service, during warranty period or beyond, call 800.444.1845.

WHAT IS NOT COVERED

- Service trips to your home to teach you how to use the product.
- Failure of the product if it is abused, misused, or used for other than the intended purpose or used commercially.
- Damage to product caused by accident, fire, floods or acts of God.
- Read your Use and Care material. If you then have any questions about operating the product, please contact your dealer or our Customer Relations office at the address below, or call, toll free:
 - GE Answer Center®
 - 800.626.2000
 - consumer information service
- Incidental or consequential damage to personal property caused by possible defects with this appliance.
- Cleaning or servicing of the air gap device in the drain line.
- Improper installation.
- Replacement of house fuses or resetting of circuit breakers.
- WARRANTOR IS NOT RESPONSIBLE FOR CONSEQUENTIAL DAMAGES.

Some states do not allow the exclusion or limitation of incidental or consequential damages, so the above limitation or exclusion may not apply to you. This warranty gives you specific legal rights, and you may also have other rights which vary from state to state. To know what your legal rights are in your state, consult your local or state consumer affairs office or your state's Attorney General.

Warrantor: General Electric Company. If further help is needed concerning this warranty, write: Manager—Customer Relations, GE Appliances, Louisville, KY 40225.

YOUR MONOGRAM DISHWASHER WARRANTY

Staple sales slip or cancelled check here. Proof of original purchase date is needed to obtain service under warranty.

WHAT IS COVERED

From the Date of the Original Purchase

ONE-YEAR

Any part of the dishwasher which fails due to a defect in materials or workmanship. During this full one-year warranty, GE will also provide, free of charge, all labor and in-home service to replace the defective part.

Second Year

Any part of the dishwasher which fails due to a defect in materials or workmanship. During this second-year limited warranty, you will be responsible for any labor or in-home service costs.

Five Years

The dishwasher rack, if it should rust, or the electronic control module if it should fail due to a defect in materials or workmanship. During this five-year limited warranty, you will be responsible for any labor or in-home service costs.

Lifetime

The stainless steel tub or door liner, if it fails to contain water due to a defect in materials or workmanship. During this full lifetime warranty, GE will also provide, free of charge, all labor and in-home service to replace the defective part.



This warranty is extended to the original purchaser and any succeeding owner for products purchased for ordinary home use in Canada. Proof of original purchase date is needed to obtain service under the warranty.

All warranty service will be provided by our Factory Service Centers or by our authorized Customer Care® servicers during normal working hours.

Should your appliance need service, during warranty period or beyond, call 1.888.880.3030.

WHAT IS NOT COVERED

- Service trips to your home to teach you how to use the product.
- Damage to product caused by accident, fire, floods or acts of God.
- Read your Use and Care material.
- Incidental or consequential damage to personal property caused by possible defects with this appliance.
- If you then have any questions about operating the product, please contact your dealer or our Consumer Relations office at the address below, or call, toll free: 1.888.880.3030
- Cleaning or servicing of the air gap device in the drain line.
- Improper installation.
- WARRANTOR IS NOT RESPONSIBLE FOR CONSEQUENTIAL DAMAGES.
- Replacement of house fuses or resetting of circuit breakers.
- Failure of the product if it is abused, misused, or used for other than the intended purpose or used commercially.

Some provinces do not allow the exclusion or limitation of incidental or consequential damages, so the above limitation or exclusion may not apply to you. This warranty gives you specific legal rights, and you may also have other rights which vary from province to province. To know what your legal rights are in your province, consult your local or provincial consumer affairs office.

Warrantor: Camco Inc. If further help is needed concerning this warranty, write: Manager, Consumer Relations, Camco Inc., 1 Factory Lane, Suite 310, Moncton, N.B. E1C 9M3.

**Consumer Product
Ownership Registration**
Important Mail Today

GE Appliances



Place
1st Class
Letter
Stamp
Here

General Electric Company
Warranty Registration Department
P.O. Box 32150
Louisville, KY 40232-2150

Consumer Product Ownership Registration

Dear Customer:

Thank you for purchasing our product and thank you for placing your confidence in us. We are proud to have you as a customer!

Follow these three steps to protect your new appliance investment:

1 Complete and mail your Consumer Product Ownership Registration today. Have the peace of mind of knowing we can contact you in the unlikely event of a safety modification.

2 After completing this registration, write your model and serial numbers in this guide. You will need this information should you require service. The service number in the USA: 800.444.1845. In Canada: 1.888.880.3030.

3 Read your "Use and Care Guide" carefully. It will help you operate your new appliance properly. If you have questions, or need more information in the USA, call the GE Answer Center® 800.626.2000. In Canada call 1.888.880.3030.

Important: To ensure that your product is registered, mail the separate product registration card. If the separate product registration card is missing, fold and mail the form below. No envelope is needed.

FOLD HERE

Consumer Product Ownership Registration

Important
Mail
Today!

Product
Dishwasher

Model

Serial

Mr. Ms. Mrs. Miss

First
Name

Last
Name

Street
Address

Apt. #

City

State

Zip
Code

Date Placed

In Use
Month

Day

Year

Phone
Number



www.monogram.com

TAPE CLOSED

Part No. C82 0046X Issue A
Part No. 165D4700P208
Pub No. 49-5882

4-00 JR



Printed in the United States