

Top-Freezer Refrigerators

Safety Information

| | |
|------------------------------|---|
| Adapter Plugs | 3 |
| Connecting Electricity | 3 |
| Extension Cords | 2 |
| Safety Precautions | 2 |

Operating Instructions

| | |
|----------------------------|-------|
| Automatic Icemaker | 8 |
| Care and Cleaning | 9, 10 |
| Shelves | 5, 6 |
| Storage Drawers | 6, 7 |
| Temperature Controls | 4 |

Installation Instructions

| | |
|--|-------|
| Preparing to Install the Refrigerator | 11 |
| Reversing the Door Swing .. | 15-21 |
| Water Line Installation | 12-15 |

Troubleshooting Tips

| | |
|--------------------------------------|-------|
| Before You Call For Service | 22-24 |
| Normal Operating Sounds | 22 |

Customer Service

| | |
|---------------------------------|-------|
| Consumer Support ... Back Cover | |
| Product Registration | 25-26 |
| Warranty | 27 |

Owner's Manual

Models
15, 16, 17, 18

Write the model and serial numbers here:

Model # _____

Serial # _____

You can find them on a label on the upper left side of the fresh food compartment.

IMPORTANT SAFETY INFORMATION. READ ALL INSTRUCTIONS BEFORE USING.

⚠ **WARNING!**

Use this appliance only for its intended purpose as described in this Owner's Manual.



SAFETY PRECAUTIONS

When using electrical appliances, basic safety precautions should be followed, including the following:

- This refrigerator must be properly installed and located in accordance with the Installation Instructions before it is used.
 - Do not allow children to climb, stand or hang on the shelves in the refrigerator. They could damage the refrigerator and seriously injure themselves.
 - Do not touch the cold surfaces in the freezer compartment when hands are damp or wet. Skin may stick to these extremely cold surfaces.
 - Do not store or use gasoline or other flammable vapors and liquids in the vicinity of this or any other appliance.
 - Keep fingers out of the "pinch point" areas; clearances between the doors and between the doors and cabinet are necessarily small.
 - Be careful closing doors when children are in the area.
 - In refrigerators with automatic icemakers, avoid contact with the moving parts of the ejector mechanism, or with the heating element that releases the cubes. Do not place fingers or hands on the automatic icemaking mechanism while the refrigerator is plugged in.
 - Unplug the refrigerator before cleaning and making repairs.
- NOTE:** We strongly recommend that any servicing be performed by a qualified individual.
- Turning the control to the **0** position does not remove power to the light circuit.
 - Do not refreeze frozen foods which have thawed completely.

⚠ **DANGER! RISK OF CHILD ENTRAPMENT**

PROPER DISPOSAL OF THE REFRIGERATOR

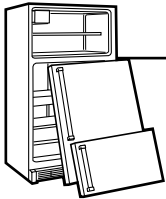

Child entrapment and suffocation are not problems of the past. Junked or abandoned refrigerators are still dangerous...even if they will sit for "just a few days." If you are getting rid of your old refrigerator, please follow the instructions below to help prevent accidents.

Before You Throw Away Your Old Refrigerator or Freezer:

- Take off the doors.
- Leave the shelves in place so that children may not easily climb inside.

CFC Disposal

Your old refrigerator has a cooling system that used CFCs (chlorofluorocarbons). CFCs are believed to harm stratospheric ozone.

If you are throwing away your old refrigerator, make sure the CFC refrigerant is removed for proper disposal by a qualified servicer. If you intentionally release this CFC refrigerant you can be subject to fines and imprisonment under provisions of environmental legislation.

USE OF EXTENSION CORDS



Because of potential safety hazards under certain conditions, we strongly recommend against the use of an extension cord.

However, if you must use an extension cord, it is absolutely necessary that it be a UL-listed, 3-wire grounding type appliance extension cord having a grounding type plug and outlet and that the electrical rating of the cord be 15 amperes (minimum) and 120 volts.

⚠ **WARNING!**

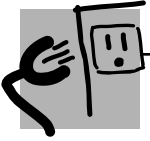

HOW TO CONNECT ELECTRICITY

Do not, under any circumstances, cut or remove the third (ground) prong from the power cord. For personal safety, this appliance must be properly grounded.

The power cord of this appliance is equipped with a 3-prong (grounding) plug which mates with a standard 3-prong (grounding) wall outlet to minimize the possibility of electric shock hazard from this appliance.

Have the wall outlet and circuit checked by a qualified electrician to make sure the outlet is properly grounded.

Where a standard 2-prong wall outlet is encountered, it is your personal responsibility and obligation to have it replaced with a properly grounded 3-prong wall outlet.

The refrigerator should always be plugged into its own individual electrical outlet which has a voltage rating that matches the rating plate.

This provides the best performance and also prevents overloading house wiring circuits which could cause a fire hazard from overheated wires.

Never unplug your refrigerator by pulling on the power cord. Always grip plug firmly and pull straight out from the outlet.

Repair or replace immediately all power cords that have become frayed or otherwise damaged. Do not use a cord that shows cracks or abrasion damage along its length or at either end.

When moving the refrigerator away from the wall, be careful not to roll over or damage the power cord.



USE OF ADAPTER PLUGS

Because of potential safety hazards under certain conditions, we strongly recommend against the use of an adapter plug.

However, if you must use an adapter, where local codes permit, a **temporary connection** may be made to a properly grounded 2-prong wall outlet by use of a UL-listed adapter available at most local hardware stores.

The larger slot in the adapter must be aligned with the larger slot in the wall outlet to provide proper polarity in the connection of the power cord.

When disconnecting the power cord from the adapter, always hold the adapter in place with one hand while pulling the power cord plug with the other hand. If this is not done, the adapter ground terminal is very likely to break with repeated use.

If the adapter ground terminal breaks, **DO NOT USE** the refrigerator until a proper ground has been established.

Attaching the adapter ground terminal to a wall outlet cover screw does not ground the appliance unless the cover screw is metal, and not insulated, and the wall outlet is grounded through the house wiring. You should have the circuit checked by a qualified electrician to make sure the outlet is properly grounded.



READ AND FOLLOW THIS SAFETY INFORMATION CAREFULLY.

SAVE THESE INSTRUCTIONS

About the temperature control dial.

Turning the dial to **0** stops cooling in both compartments—fresh food and freezer. It does not shut off power to the refrigerator.

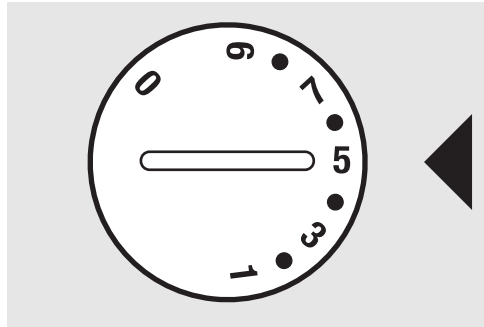

Control Settings

Temperature Control Dial

The temperature control dial has nine settings plus **0**. **1** is the warmest. **9** is the coldest. At first, set the dial at **5**.

After using the refrigerator, adjust the dial if necessary.

Insert a coin into the slot in the middle of the dial and you can turn the dial to the setting that's best suited to your needs.

Allow 24 hours for the refrigerator to get cold.

About the fresh food compartment shelves.

www.Hotpoint.com

Shelf supports at various levels allow you to custom-space your shelves. Not all features are on all models.

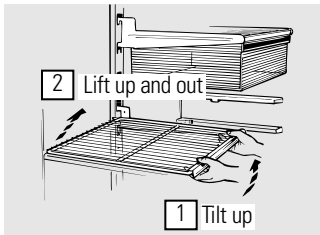

Half-Width Shelves

One end of the shelf rests on a molded side-wall support; a bracket on the other end hooks into a track on the rear cabinet wall.

To remove, lift the shelf up at front, then off the support and out of the track.

To replace, select desired shelf height. With shelf front raised slightly, hook the bracket's top lug into the track, then lower the shelf onto the support.

NOTE: The shelf to the right of the track is designed to hook into the right-hand slot; the shelf to the left is designed to hook into the left-hand slot.

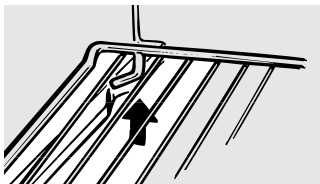
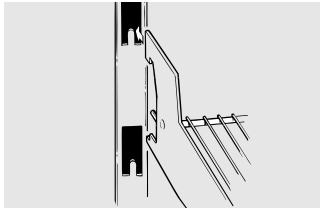

Full-Width Shelves

Some models have a steel wire sliding shelf, a stationary tempered glass shelf or two steel wire stationary shelves. These shelves can be moved to another place in the fresh food compartment.

The full-width sliding shelf has stop-locks. When placed correctly on the shelf supports, the shelf will stop before coming completely out of the refrigerator and will not tilt when you place food on it or remove food from it.

To remove the full-width shelves, lift the rear of the shelf and pull forward.

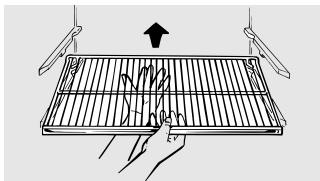

To remove a full-width shelf when the fresh food compartment door cannot be opened fully, lift the rear of the shelf, pull forward and down, tilt the shelf and take it out.

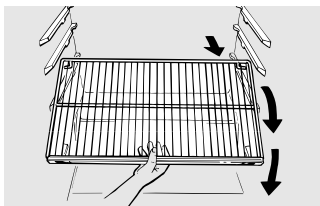

Safety Instructions

Operating Instructions

Installation Instructions

Troubleshooting Tips

Consumer Support

About the freezer compartment shelves.

Some models have an ice-tray shelf and some have a full-width step shelf.

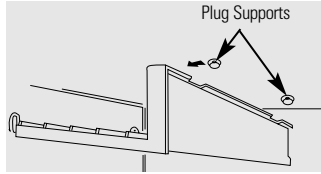

Ice-Tray Shelf

To remove the ice-tray shelf, lift the left side of the shelf off its supports, then pull the shelf to the left to free it of the plug supports. Pull the shelf to the right to free the pins from the holes in the cabinet wall.

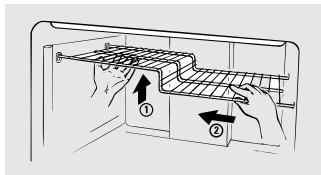

Step Shelf

To remove the step shelf:

- 1 Lift left side of shelf slightly.
- 2 Move shelf to the left to free its right ends from holes in the cabinet wall.
- 3 Lower right side of shelf, move shelf to the right and take it out.

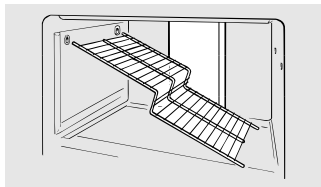

To replace the step shelf:

- 1 With shelf tilted as shown, fit left ends of shelf into holes in cabinet wall.
- 2 Lift left side of shelf slightly, swing shelf up, fit right ends of shelf into holes in cabinet wall, and lower shelf into place.

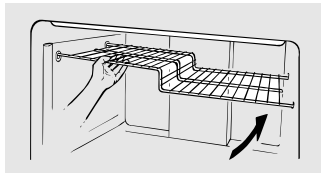

About the storage drawers.

Not all features are on all models.

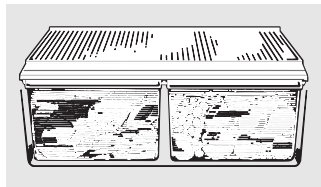

Fruit and Vegetable Drawers

Excess water that may accumulate in the bottom of the drawers should be emptied and the drawers wiped dry.

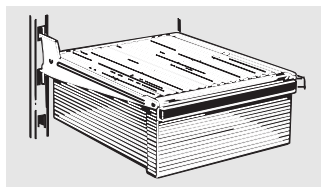

Utility Drawer

The utility drawer can be moved to the most useful location for your family's needs.

Not all features are on all models.

Drawer and Cover Removal

Drawers can be removed easily by grasping the sides and lifting up slightly while pulling drawers past the **stop** location.

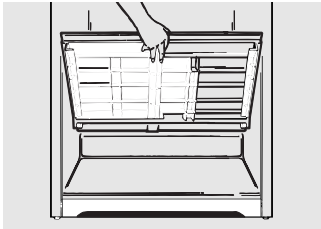

Full-Width Drawer with Plastic Cover

To remove the cover, lift it off its supports, pull it forward, tilt it and take it out.

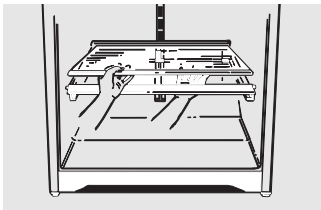

Twin Drawers with Glass Cover

To remove:

- 1 Remove the drawers.
- 2 Reach in, push the front of glass cover up, and at the same time, pull it forward as far as it will come.

Tilt it and take it out. Avoid cleaning the cold glass cover with hot water because the extreme temperature difference may cause it to break.

- 3 Remove the drawer frame. (Always remove the glass cover before you take out the drawer frame.)

Lift the frame off the supports at each side and back, pull it forward, tilt it and take it out.

To replace:

- 1 Lower the frame until it rests on the supports at each side and back.
- 2 Replace the glass cover, pushing its rear edge firmly into the rear frame channel and gently lowering the front into place.
- 3 Replace the drawers.

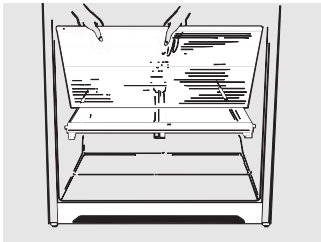

About the automatic icemaker.

A newly-installed refrigerator may take 12 to 24 hours to begin making ice.

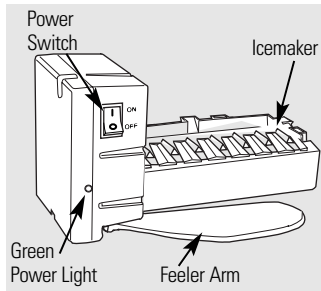

Automatic Icemaker (on some models)

The icemaker will produce seven cubes per cycle—approximately 100–130 cubes in a 24-hour period, depending on freezer compartment temperature, room temperature, number of door openings and other use conditions.

If the refrigerator is operated before the water connection is made to the icemaker, set the power switch to **OFF**.

When the refrigerator has been connected to the water supply, set the power switch to **ON**. The green power light will come on.

The icemaker will fill with water when it cools to freezing. A newly installed refrigerator may take 12 to 24 hours to begin making ice cubes.

Throw away the first few batches of ice to allow the water line to clear.

Be sure nothing interferes with the sweep of the feeler arm.

When the bin fills to the level of the feeler arm, the icemaker will stop producing ice.

It is normal for several cubes to be joined together.

If ice is not used frequently, old ice cubes will become cloudy, taste stale and shrink.

If ice cubes get stuck in the icemaker, the green power light will blink. To correct this, set the power switch to **OFF** and remove the cubes. Set the power switch to **ON** to restart the icemaker.

NOTE: In homes with lower-than-average water pressure, you may hear the icemaker cycle multiple times when making one batch of ice.

Icemaker Accessory Kit

If your refrigerator did not already come equipped with an automatic icemaker, an icemaker accessory kit is available at extra cost.

Check the back of the refrigerator for the specific icemaker kit needed for your model.

Cleaning the Outside

The door handles and trim (on some models). Clean with a cloth dampened with soapy water. Dry with a soft cloth.

Keep the outside clean. Wipe with a clean cloth lightly dampened with kitchen appliance wax or mild liquid dish detergent. Dry and polish with a clean, soft cloth.

Do not wipe the refrigerator with a soiled dish cloth or wet towel. These may leave a residue that can erode the paint. Do not use scouring pads, powdered cleaners, bleach or cleaners containing bleach because these products can scratch and weaken the paint finish.

Cleaning the Inside

To help prevent odors, leave an open box of baking soda in the fresh food and freezer compartments.

Unplug the refrigerator before cleaning. If this is not practical, wring excess moisture out of sponge or cloth when cleaning around switches, lights or controls.

Use warm water and baking soda solution—about a tablespoon (15 ml) of baking soda to a quart (1 liter) of water. This both cleans and neutralizes odors. Rinse and wipe dry.

After cleaning the door gaskets, apply a thin layer of petroleum jelly to the door gaskets at the hinge side. This helps keep the gaskets from sticking and bending out of shape.

Avoid cleaning cold glass shelves (on some models) with hot water because the extreme temperature difference may cause them to break. Handle glass shelves carefully. Bumping tempered glass can cause it to shatter.

Do not wash any plastic refrigerator parts in the dishwasher.

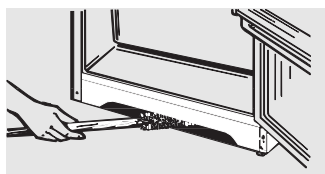

Cleaning the condenser coils.

Condenser

There is no need for routine condenser cleaning in normal home operating environments. However, in environments that may be particularly dusty or greasy, the condenser should be cleaned periodically for efficient refrigerator operation.

To clean the condenser, turn the temperature control dial to **0**. Sweep away or vacuum up dust.

For best results, use a brush specially designed for this purpose. It is available at most appliance parts stores.

Care and cleaning of the refrigerator.

Behind the Refrigerator

Be careful when moving the refrigerator away from the wall. All types of floor coverings can be damaged, particularly cushioned coverings and those with embossed surfaces.

Turn the leveling legs at each front corner of the refrigerator counterclockwise until the rollers support the refrigerator. Pull the refrigerator straight out and return it to position by pushing it straight in. Moving the refrigerator in a side direction may result in damage to the floor covering or refrigerator.

When pushing the refrigerator back, make sure you don't roll over the power cord or icemaker supply line (on some models).

After rolling the refrigerator back into place, turn the legs clockwise until the legs again bear the weight of the refrigerator.

Light Bulb Replacement

To replace a burned-out bulb, unplug the refrigerator from its electrical outlet, unscrew the bulb when cool and replace it with an appliance bulb of the same or lower wattage.

*Turning the control to the **0** position does not remove power to the light circuit.*

Preparing for Vacation

For long vacations or absences, remove food and unplug the refrigerator. Move the temperature control dial to the **0** position, and clean the interior with a baking soda solution of one tablespoon (15 ml) of baking soda to one quart (1 liter) of water. Leave the doors open.

Set the icemaker power switch to **OFF** and shut off the water supply to the refrigerator.

If the temperature can drop below freezing, have a qualified servicer drain the water supply system (on some models) to prevent serious property damage due to flooding.

Preparing to Move

Secure all loose items such as grille, shelves and drawers by taping them securely in place to prevent damage.

Be sure the refrigerator stays in an upright position during moving.

Installation Instructions

Refrigerator

Models 15, 16, 17, 18

If you have questions, call 1-800-GECARES or visit our Website at: www.Hotpoint.com

BEFORE YOU BEGIN

Read these instructions completely and carefully.

- **IMPORTANT** – Save these instructions for local inspector's use.
- **IMPORTANT** – Observe all governing codes and ordinances.
- **Note to Installer** – Be sure to leave these instructions with the Consumer.
- **Note to Consumer** – Keep these instructions for future reference.
- **Skill level** – Installation of this appliance requires basic mechanical skills.
- **Completion time** – Refrigerator Installation
15 minutes
Reversing the Door Swing
1 hour
- Proper installation is the responsibility of the installer.
- Product failure due to improper installation is not covered under the Warranty.

WATER SUPPLY TO THE ICEMAKER (on some models)

If the refrigerator has an icemaker, it will have to be connected to a cold water line. A water supply kit (containing copper tubing, shutoff valve, fittings and instructions) is available at extra cost from your dealer or from Parts and Accessories, 800-626-2002.

REFRIGERATOR LOCATION

- Do not install the refrigerator where the temperature will go below 60°F (16°C) because it will not run often enough to maintain proper temperatures.
- Install it on a floor strong enough to support it fully loaded.

CLEARANCES

Allow the following clearances for ease of installation, proper air circulation and plumbing and electrical connections.

- Sides 3/4" (19 mm)
- Top 1" (25 mm)
- Back 1" (25 mm)

ROLLERS AND LEVELING LEGS

Leveling legs near each front corner of the refrigerator are adjustable. They firmly position the refrigerator and prevent it from moving when the doors are opened. Leveling legs should be set so the front of the refrigerator is raised just enough that the doors close easily when opened about halfway.

Turn the leveling legs **clockwise to raise** the refrigerator, **counterclockwise to lower it**.

Rollers next to the leveling legs allow you to move the refrigerator away from the wall for cleaning.

Turn the legs counterclockwise until the weight of the refrigerator is transferred from them to the rollers. After rolling the refrigerator back into place, turn the legs clockwise until the legs again bear the weight of the refrigerator.

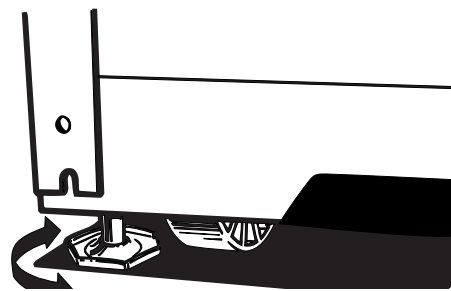

Installation Instructions

1 INSTALLING THE WATER LINE

BEFORE YOU BEGIN

This water line installation is not warranted by the refrigerator or icemaker manufacturer. Follow these instructions carefully to minimize the risk of expensive water damage.

Water hammer (water banging in the pipes) in house plumbing can cause damage to refrigerator parts and lead to water leakage or flooding. Call a qualified plumber to correct water hammer before installing the water supply line to the refrigerator.

To prevent burns and product damage, do not hook up the water line to the hot water line.

If you use your refrigerator before connecting the water line, make sure the icemaker power switch is in the **OFF** position.

Do not install the icemaker tubing in areas where temperatures fall below freezing.

When using any electrical device (such as a power drill) during installation, be sure the device is insulated or wired in a manner to prevent the hazard of electric shock.

All installations must be in accordance with local plumbing code requirements.

WHAT YOU WILL NEED

To determine how much copper tubing you need:

Measure the distance from the water valve on the back of the refrigerator to the water supply pipe. Then add 8 feet (244 cm). Be sure there is sufficient extra tubing [about 8 feet (244 cm) coiled into 3 turns of about 10 inches (25 cm) diameter] to allow the refrigerator to move out from the wall after installation.

- **A water supply kit** (containing copper tubing, shutoff valve and fittings listed below) is available at extra cost from your dealer or from Parts and Accessories, 800-626-2002.
- **A cold water supply.** The water pressure must be between 20 and 120 p.s.i. (1.4–8.1 bar).

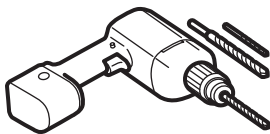

- **Power drill.**

WHAT YOU WILL NEED (CONT.)

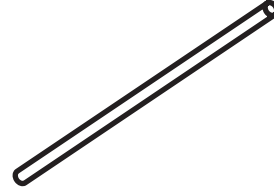

- **Copper tubing**, 1/4" outer diameter to connect the refrigerator to the water supply. Be sure both ends of the tubing are cut square.

Do not use plastic tubing or plastic fittings because the water supply line is under pressure at all times. Certain types of plastic tubing may become brittle with age and crack, resulting in water leakage.

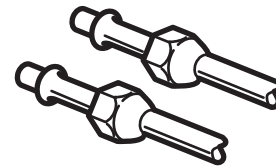

- **Two 1/4" outer diameter compression nuts and 2 ferrules (sleeves)**—to connect the copper tubing to the shutoff valve and the refrigerator water valve.

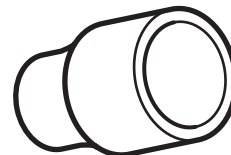

- If your existing water line has a flared fitting at the end, you will need an **adapter** (available at plumbing supply stores) to connect the water line to the refrigerator **OR** you can cut off the flared fitting with a **tube cutter** and then use a compression fitting.

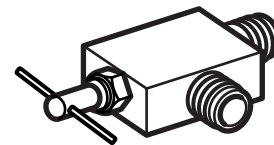

- **Shutoff valve** to connect to the cold water line. The shutoff valve should have a water inlet with a minimum inside diameter of 5/32" at the point of connection to the **COLD WATER LINE**. Saddle-type shutoff valves are included in many water supply kits. Before purchasing, make sure a saddle-type valve complies with your local plumbing codes.

Installation Instructions

Install the shutoff valve on the nearest frequently used drinking water line.

1 SHUT OFF THE MAIN WATER SUPPLY

Turn on the nearest faucet long enough to clear the line of water.

2 CHOOSE THE VALVE LOCATION

Choose a location for the valve that is easily accessible. It is best to connect into the side of a vertical water pipe. When it is necessary to connect into a horizontal water pipe, make the connection to the top or side, rather than at the bottom, to avoid drawing off any sediment from the water pipe.

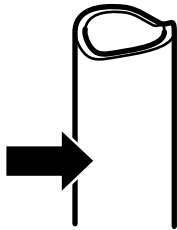

3 DRILL THE HOLE FOR THE VALVE

Drill a 1/4" hole in the water pipe, using a sharp bit. Remove any burrs resulting from drilling the hole in the pipe.

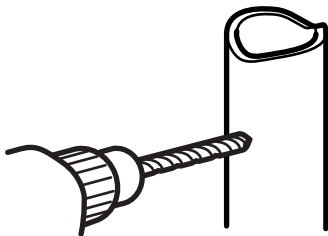

4 FASTEN THE SHUTOFF VALVE

Fasten the shutoff valve to the cold water pipe with the pipe clamp.

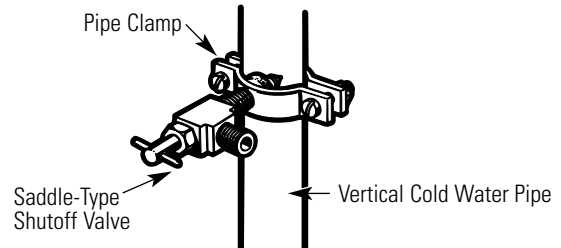

5 TIGHTEN THE PIPE CLAMP

Tighten the clamp screws until the sealing washer begins to swell.

NOTE: Do not overtighten or you may crush the copper tubing.

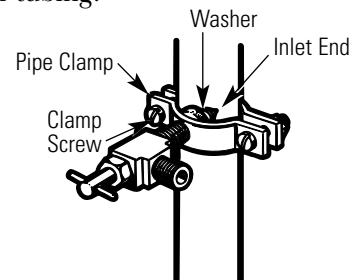

6 ROUTE THE TUBING

Route the copper tubing between the cold water line and the refrigerator.

Route the tubing through a hole drilled in the wall or floor (behind the refrigerator or adjacent base cabinet) as close to the wall as possible.

NOTE: Be sure there is sufficient extra tubing [about 8 feet (244 cm) coiled into 3 turns of about 10" (25 cm) diameter] to allow the refrigerator to move out from the wall after installation.

Installation Instructions

1 INSTALLING THE WATER LINE (CONT.)

7 CONNECT THE TUBING TO THE VALVE

Place the compression nut and ferrule (sleeve) onto the end of the tubing and connect it to the shutoff valve.

Make sure the tubing is fully inserted into the valve. Tighten the compression nut securely.

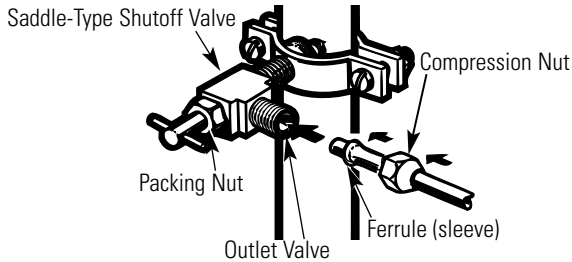

8 FLUSH OUT THE TUBING

Turn the main water supply on and flush out the tubing until the water is clear.

Shut the water off at the water valve after about one quart (1 liter) of water has been flushed through the tubing.

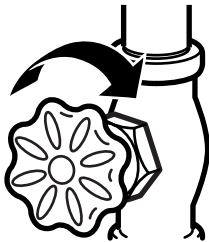

9 CONNECT THE TUBING TO THE REFRIGERATOR

NOTES:

- Before making the connection to the refrigerator, be sure the refrigerator power cord is not plugged into the wall outlet.
- We recommend installing a water filter if your water supply has sand or particles that could clog the screen of the refrigerator's water valve. Install it in the water line near the refrigerator.

9 CONNECT THE TUBING TO THE REFRIGERATOR (CONT.)

9.1 Remove the access cover.

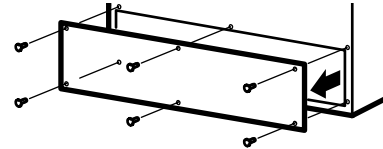

9.2 Remove the plastic flexible cap from the water valve.

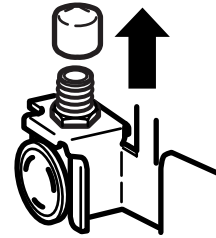

9.3 Place the compression nut and ferrule (sleeve) onto the end of the tubing as shown.

Insert the end of the copper tubing into the water valve connection as far as possible. While holding the tubing, tighten the fitting.

Fasten the copper tubing into the clamp provided to hold it in a vertical position. You may need to pry open the clamp.

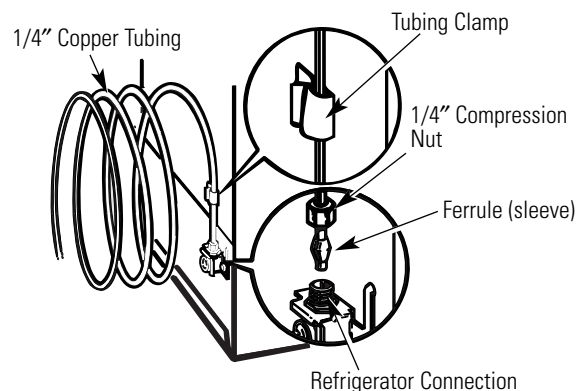

9.4 Reattach the access cover.

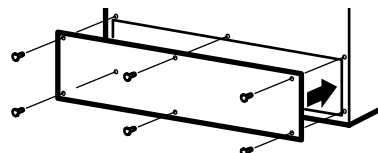

Installation Instructions

10 TURN THE WATER ON AT THE SHUTOFF VALVE

Tighten any connections that leak.

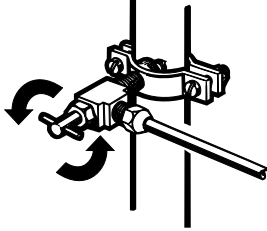

11 PLUG IN THE REFRIGERATOR

Arrange the coil of copper tubing so that it does not vibrate against the back of the refrigerator or against the wall. Push the refrigerator back to the wall.

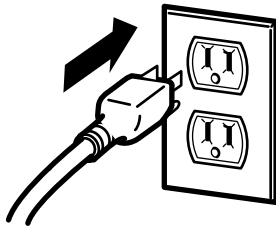

12 START THE ICEMAKER

Set the icemaker power switch to the **ON** position. The icemaker will not begin to operate until it reaches its operating temperature of 15°F (-9°C) or below. It will then begin operation automatically if the icemaker power switch is in the **ON** position.

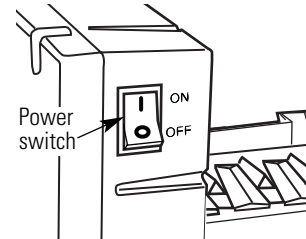

NOTE: In lower water pressure conditions, the water valve may turn on up to 3 times to deliver enough water to the icemaker.

2 REVERSING THE DOOR SWING

IMPORTANT NOTES

When reversing the door swing:

- Read the instructions all the way through before starting.
- Handle parts carefully to avoid scratching paint.
- Set screws down by their related parts to avoid using them in the wrong places.
- Provide a non-scratching work surface for the doors.

IMPORTANT: Once you begin, do not move the cabinet until door-swing reversal is completed.

These instructions are for changing the hinges from the right side to the left side—if you ever want to change the hinges back to the right side, follow these same instructions and reverse all references to left and right.

TOOLS REQUIRED

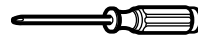

Phillips screwdriver



Masking tape



5/16" hex-head socket driver



T20 or T25 Torxdriver, whichever your model requires



Putty knife or thin-blade screwdriver



5/16" open-end wrench

Installation Instructions

2 REVERSING THE DOOR SWING (CONT.)

1 BEFORE YOU START

1.1 Unplug the refrigerator from its electrical outlet.

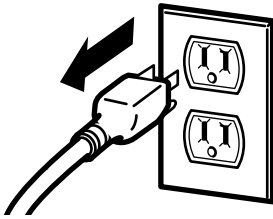

1.2 Empty all door shelves, including the dairy compartment.



CAUTION: Do not let either door drop to the floor. To do so could damage the door stop.

2 REMOVE THE FREEZER DOOR

2.1 Tape the door shut with masking tape.

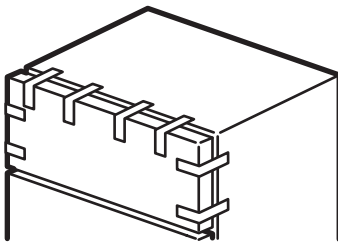

2 REMOVE THE FREEZER DOOR (CONT.)

2.2 With a 5/16" hex-head socket driver, remove the screws that hold the top hinge to the cabinet.

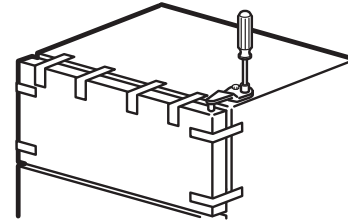

2.3 Lift the hinge (and the shim glued to it) straight up to free the hinge pin from the socket in the top of the door and set it aside, along with its screws.

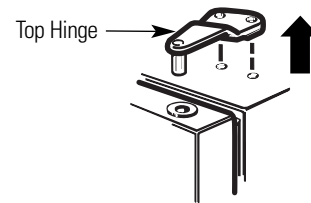

2.4 Remove the tape and tilt the door away from the cabinet. Lift it off the center hinge pin.

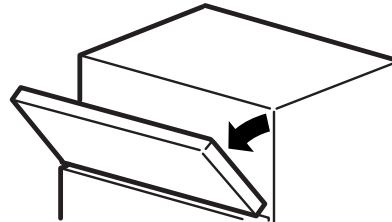

2.5 Set the door on a non-scratching surface with the outside up.

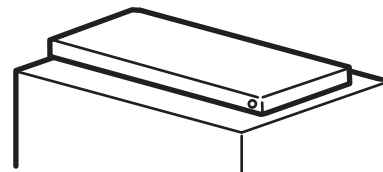

Installation Instructions

2 REMOVE THE FREEZER DOOR (CONT.)

2.6 Using a Torxdriver, transfer the 2 screws from the opposite side of the cabinet to the screw holes vacated by the top hinge removal.

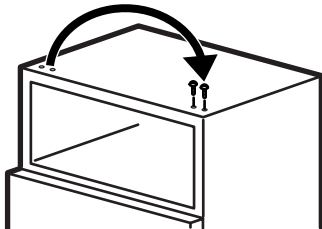

3 REMOVE THE FRESH FOOD DOOR (CONT.)

3.4 Set the door outside-up on a non-scratching surface.

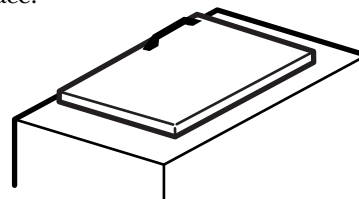

3 REMOVE THE FRESH FOOD DOOR

3.1 Tape the door shut with masking tape.

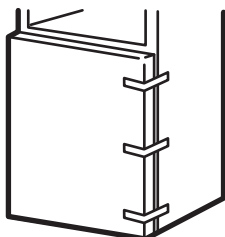

3.2 Using a 5/16" hex-head socket screwdriver and a 5/16" open-end wrench, remove the two screws holding the center hinge (and the shim glued to it) to the cabinet. Lift the center hinge to free its pin from the socket in the top of the door, and set hinge and screws aside. **Be careful not to lose the center hinge spacer and washer.**

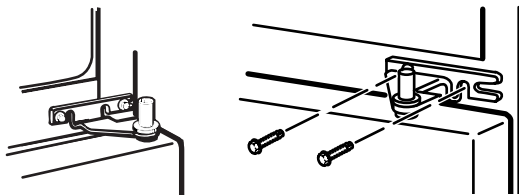

3.5 Using a Torxdriver, transfer the two screws from the opposite side of the cabinet to the screw holes vacated by the center hinge removal.

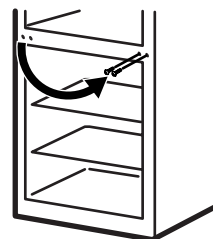

3.6 Transfer the washer (if your model has one) to the opposite side.

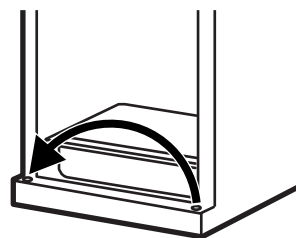

3.3 Remove the tape and tilt the door away from the cabinet. Lift the door from the pin in the bottom hinge bracket. (If the plastic washer sticks to the door bottom, put it back on the hinge.)

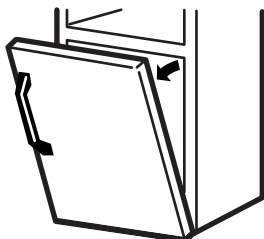

3.7 Take one of the screws removed in step 2 and start it in the outermost screw hole on the opposite side. Do not drive it all the way down—leave enough space under the screw head for thickness of shim and bracket.

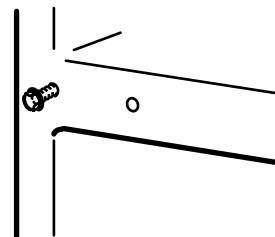

Installation Instructions

2 REVERSING THE DOOR SWING (CONT.)

4 REVERSING THE HARDWARE

4.1 Remove the base grille (if your refrigerator has one) by pulling it straight out.

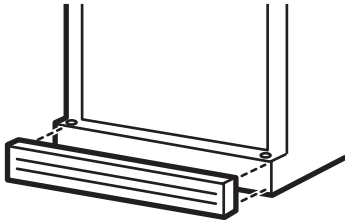

4.2 Using a Torxdriver, move the bottom hinge bracket (and shim glued to it) and plastic washer from the right side to the left side.

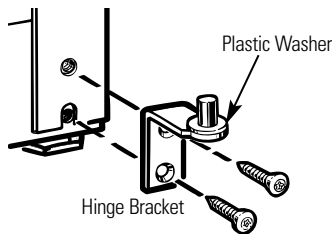

4.3 Interchange hinge (and the shim glued to it) and screws at top right with screws at top left of cabinet. **Do not tighten screws on hinge side at this time.**

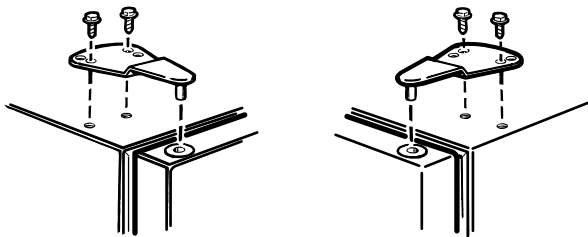

Installing the hinge on the left.

Installing the hinge on the right.

NOTES:

- Some hinges have four holes. Which holes you use for installing the hinge depends on which side you install the hinge.
- The outer edge of the hinge should be parallel to the edge of the case for correct installation.

5 REVERSING THE DOOR HANDLES

5.1 Transfer fresh food door handle

5.1.1 Remove the bottom cap by pushing it toward the bottom of the door, and remove the screw underneath. Remove the two screws holding the handle to the top of the door.

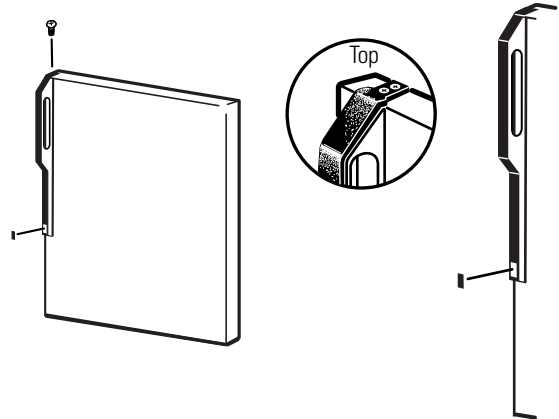

5.1.2 Remove the handle.

5.1.3 Remove the screws from the right edge of the door top and insert them into the handle screw holes on the opposite side.



Installation Instructions

5 REVERSING THE DOOR HANDLES (CONT.)

5.1 Transfer fresh food door handle (cont.)

5.1.4 With tape-tipped putty knife or thin-blade screwdriver, pry out the plug button from the hinge hole on the left side of the door and insert it into the hole on the opposite side that was vacated by removal of the top hinge.

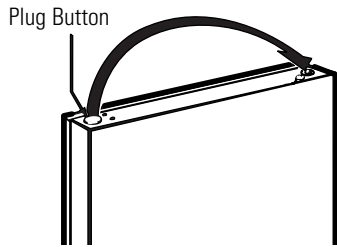

5.1.5 Pull the plug button from the front of the door and transfer it to the opposite side.

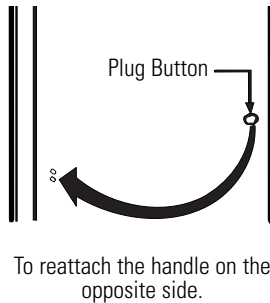

5.2 Transfer door stop

5.2.1 Move the metal door stop from the right end to the left end. Use a Torxdriver.

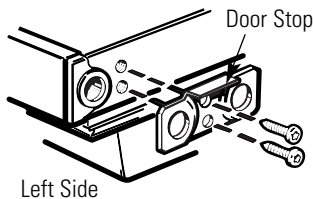

5.2 Transfer door stop (cont.)

5.2.2 Move any screws from the left end to the right end.

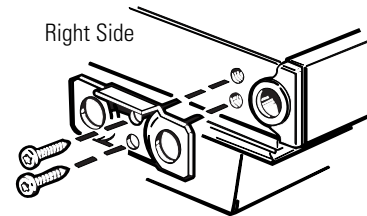

5.3 Reinstalling the Fresh Food Door Handle

5.3.1 Attach the handle to the right side of the door with screws at the top and under the handle plug.

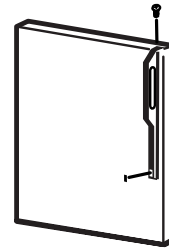

5.3.2 Reinstall the handle plug.

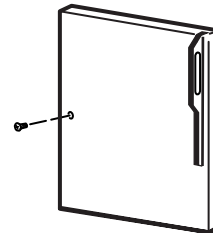

Installation Instructions

2 REVERSING THE DOOR SWING (CONT.)

5.4 Transfer Freezer Door Handle

5.4.1 Remove the screw holding the handle to the top of the door and the two screws holding the handle to the bottom of the door.

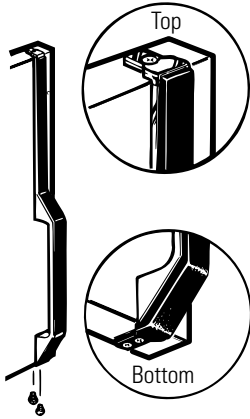

5.4 Transfer Freezer Door Handle (cont.)

5.4.4 Transfer the door stop as shown on the preceding page.

5.4.5 Attach the handle to the right edge of the door with screws at top and bottom, using bottom holes vacated by removal of the door stop screws.

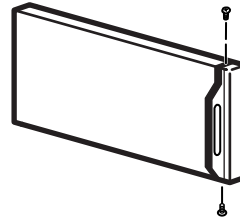

5.4.2 Remove the handle.

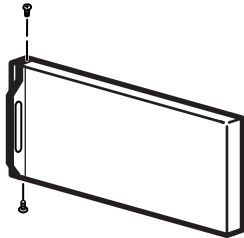

5.4.3 Remove the screw from the right top edge of the door and insert it into the handle screw hole on the left side.

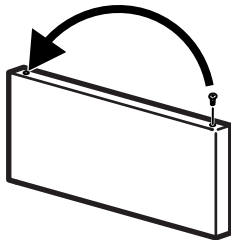

Installation Instructions

6 REHANGING THE DOORS

6.1 Rehang the fresh food door

6.1.1 Lower the fresh food door onto the bottom hinge pin. **Be sure the washer is in place on the pin.**

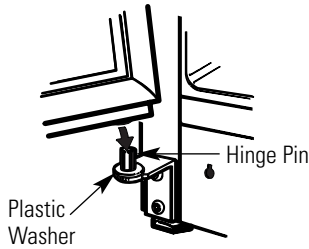

6 REHANGING THE DOORS (CONT.)

6.2 Rehang the freezer door

6.2.1 Lower the freezer door onto the center hinge pin. **Be sure the washer and spacer are in place on the pin.**

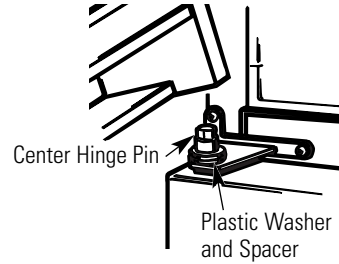

6.1.2 Insert the pin on the center hinge into the socket in the top of the door. Place the spacer, then the washer, on the hinge pin. **NOTE:** The center hinge must be turned over as shown when mounted on the left side.

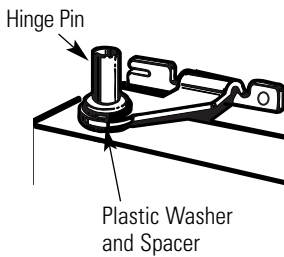

6.2.2 Tilt the door toward the cabinet, lifting the top hinge so the pin fits into the socket on the top of the door.

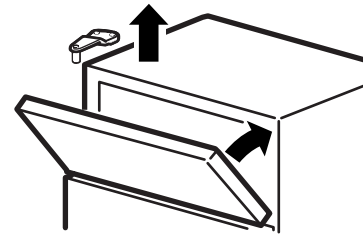

6.1.3 Tilt the door toward the cabinet. As the door is brought into position, slide the hinge under the head of the screw which earlier had been partly driven into the outermost hole. Insert the remaining screw, then tighten both screws securely.

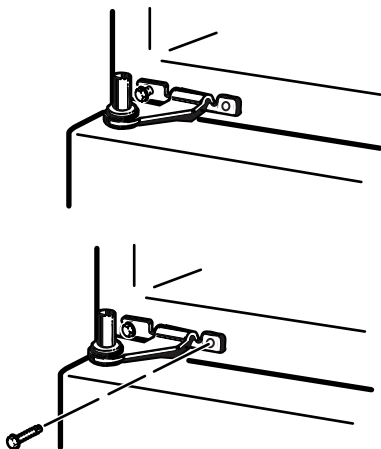

6.2.3 Make sure the door is slightly above the top of the cabinet and the gap between the doors is even across the front. Tighten the top hinge screws. Do not overtighten these screws—tighten them until they are just snug, then turn them another one-half turn.

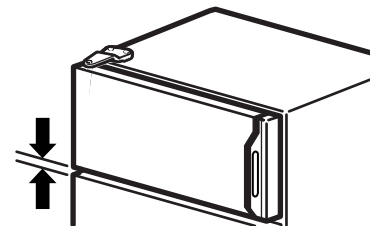

Normal operating sounds.



Depending on the placement of the refrigerator in your kitchen, you may want to place a piece of rubber-backed carpet under the refrigerator to reduce noise.

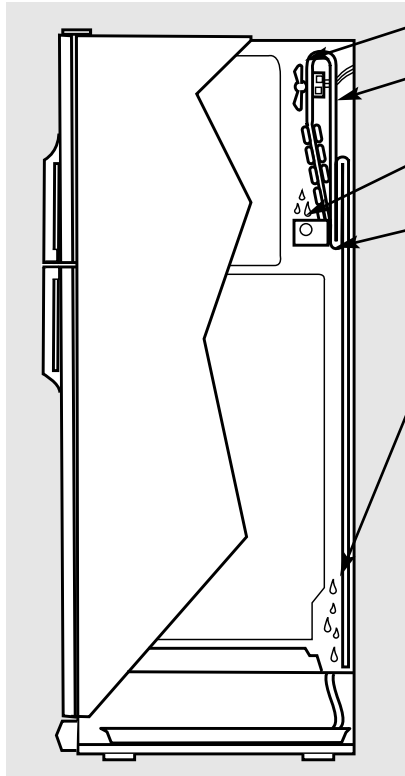

- The fan circulating air inside the freezer which keeps the temperatures even.
- Boiling water or a gurgling noise. The flow of refrigerant through the freezer cooling coils.
- Sizzling, hissing or popping sound. Water dropping on the defrost heater during the defrost cycle.
- Cracking or popping sound. Cooling coils expanding and contracting during the defrosting cycle.
- Water dripping as it melts from the evaporator and flows to the drain pan during the defrost cycle.

Icemaker (on some models)

The icemaker water valve will buzz when the icemaker fills with water. If the power switch is in the **ON** position it will buzz even if it has not yet been hooked up to water. Keeping the power switch in the **ON** position before it is hooked up to water can damage the icemaker. To prevent this, move the power switch to the **OFF** position. This will stop the buzzing.

The sound of cubes dropping into the bin and water running in pipes as icemaker refills.

These sounds are normal and are due mostly to highly efficient operation.



Troubleshooting Tips
Save time and money! Review the charts on the following pages first and you may not need to call for service.

| Problem | Possible Causes | What To Do |
|---|---|---|
| Refrigerator does not operate | Refrigerator in defrost cycle. | • Wait about 30 minutes for defrost cycle to end. |
| | Temperature control dial in 0 position. | • Move the temperature control dial to a temperature setting. |
| | Refrigerator is unplugged. | • Push the plug completely into the outlet. |
| | The fuse is blown/circuit breaker is tripped. | • Replace fuse or reset the breaker. |
| Vibration or rattling (slight vibration is normal) | Roller screws or leveling legs need adjusting. | • See <i>Rollers and Leveling Legs</i> . |

| Problem | Possible Causes | What To Do |
|---|---|--|
| Motor operates for long periods or cycles on and off frequently. (Modern refrigerators with more storage space and a larger freezer require more operating time. They start and stop often to maintain even temperatures.) | Normal when refrigerator is first plugged in. | • Wait 24 hours for the refrigerator to completely cool down. |
| | Often occurs when large amounts of food are placed in refrigerator. | • This is normal. |
| | Door left open. | • Check to see if package is holding door open. |
| | Hot weather or frequent door openings. | • This is normal. |
| | Temperature control dial set at the coldest setting. | • See <i>About the temperature control dial</i> . |
| Fresh food or freezer compartment too warm | Grille and condenser need cleaning. | • See <i>Care and cleaning</i> . |
| | Temperature control dial not set cold enough. | • See <i>About the temperature control dial</i> . |
| | Warm weather or frequent door openings. | • Set the temperature control dial one step colder. See <i>About the temperature control dial</i> . |
| | Door left open. | • Check to see if package is holding door open. |
| Frost or ice crystals on frozen food (frost within package is normal) | Package blocking air duct in freezer compartment. | • Check to see if package is blocking air duct in freezer compartment. |
| | Door left open. | • Check to see if package is holding door open. |
| Automatic icemaker does not work (on some models) | Too frequent or too long door openings. | • Check to see if package is holding door open. |
| | Icemaker power switch in the OFF position. | • Move the switch to the ON position. • Cubes may have fused to the side of the mold. Move the switch to the OFF position, then remove the cubes. |
| | Water supply turned off or not connected. | • See <i>Installing the water line</i> . |
| | Freezer compartment too warm. | • Wait 24 hours for the refrigerator to completely cool down. |
| Cubes too small | Piled up cubes in the storage bin cause the icemaker to shut off. | • Level cubes by hand. |
| | Water shutoff valve connecting refrigerator to water line may be clogged. | • Call the plumber to clear the valve. |
| Slow ice cube freezing | Door left open. | • Check to see if package is holding door open. |
| | Temperature control dial not set cold enough. | • See <i>About the temperature control dial</i> . |
| Ice cubes have odor/taste | Ice storage bin needs cleaning. | • Empty and wash bin. Discard old cubes. |
| | Food transmitting odor/taste to ice cubes. | • Wrap foods well. |
| | Interior of refrigerator needs cleaning. | • See <i>Care and cleaning</i> . |

Before you call for service...



Troubleshooting Tips

| Problem | Possible Causes | What To Do |
|--|---|---|
| Moisture forms on cabinet surface between the doors | Not unusual during periods of high humidity. | <ul style="list-style-type: none"> Wipe surface dry and reset temperature control dial one setting colder. |
| Moisture collects inside (in humid weather, air carries moisture into refrigerator when doors are opened) | Too frequent or too long door openings. | |
| Refrigerator has odor | <p>Foods transmitting odor to refrigerator.</p> <hr/> <p>Interior needs cleaning.</p> | <ul style="list-style-type: none"> Foods with strong odors should be tightly wrapped. Keep an open box of baking soda in the refrigerator; replace every three months. See <i>Care and cleaning</i>. |

GE Service Protection Plus™

GE, a name recognized worldwide for quality and dependability, offers you Service Protection Plus™—comprehensive protection on all your appliances—**No Matter What Brand!**

Benefits Include:

- Backed by GE
- All brands covered
- Unlimited service calls
- All parts and labor costs included
- No out-of-pocket expenses
- No hidden deductibles
- One 800 number to call

***We'll Cover Any Appliance.
Anywhere. Anytime.****

You will be completely satisfied with our service protection or you may request your money back on the remaining value of your contract. No questions asked. It's that simple.

Protect your refrigerator, dishwasher, washer and dryer, range, TV, VCR and much more—**any brand!** Plus there's no extra charge for emergency service and low monthly financing is available. Even icemaker coverage and food spoilage protection is offered. You can rest easy, knowing that all your valuable household products are protected against expensive repairs.

Place your confidence in GE and call us in the U.S. toll-free at **800-626-2224** for more information.

*All brands covered, up to 20 years old, in the continental U.S.

 Cut here

Please place in envelope and mail to:

General Electric Company
Warranty Registration Department
P.O. Box 32150
Louisville, KY 40232-2150

Consumer Product Ownership Registration

Dear Customer:

Thank you for purchasing our product and thank you for placing your confidence in us.

We are proud to have you as a customer!

Follow these three steps to protect your new appliance investment:

1 Complete and mail your Consumer Product Ownership Registration today. Have the peace of mind of knowing we can contact you in the unlikely event of a safety modification.

2 After mailing the registration below, store this document in a safe place. It contains information you will need should you require service. Our service number in the USA is: 800 GE CARES (800-432-2737).

3 Read your Owner's Manual carefully. It will help you operate your new appliance properly.

Model Number

Serial Number

Important: If you did not get a registration card with your product, detach and return the form below to ensure that your product is registered, or register online at www.GEAppliances.com.

 Cut here

Consumer Product Ownership Registration



Model Number

Serial Number

Mr. Ms. Mrs. Miss

First Name

Last Name

Street Address

Apt. #

E-mail Address

City

State

Zip Code

Date Placed In Use
Month

Day

Year

Phone Number --

Occasionally, we may allow selected companies to send you information.

Check here if you do not want this information.



GE Appliances

HOTPOINT

General Electric Company
Louisville, Kentucky
www.GEAppliances.com

Refrigerator Warranty.

All warranty service provided by our Factory Service Centers, or an authorized Customer Care® technician. To schedule service, on-line, 24 hours a day, contact us at www.Hotpoint.com, or call 800-GE-CARES.

Staple your receipt here. Proof of the original purchase date is needed to obtain service under the warranty.

| For The Period Of: | We Will Replace: |
|---|---|
| One Year From the date of the original purchase | Any part of the refrigerator which fails due to a defect in materials or workmanship. During this full one-year warranty , we will also provide, free of charge , all labor and in-home service to replace the defective part. |
| Five Years From the date of the original purchase | Any part of the sealed refrigerating system (the compressor, condenser, evaporator and all connecting tubing) which fails due to a defect in materials or workmanship. During this additional four-year warranty , we will also provide, free of charge , all labor and in-home service to replace the defective part. |

What Is Not Covered:

- Service trips to your home to teach you how to use the product.
- Improper installation.
- Failure of the product if it is abused, misused, or used for other than the intended purpose or used commercially.
- Loss of food due to spoilage.
- Replacement of house fuses or resetting of circuit breakers.
- Damage to the product caused by accident, fire, floods or acts of God.
- Incidental or consequential damage caused by possible defects with this appliance.

This warranty is extended to the original purchaser and any succeeding owner for products purchased for home use within the USA. In Alaska, the warranty excludes the cost of shipping or service calls to your home.

Some states do not allow the exclusion or limitation of incidental or consequential damages. This warranty gives you specific legal rights, and you may also have other rights which vary from state to state. To know what your legal rights are, consult your local or state consumer affairs office or your state's Attorney General.

Warrantor: General Electric Company, Louisville, KY 40225

Consumer Support.



Hotpoint Website

www.Hotpoint.com

Have a question or need assistance with your appliance? Try the Hotpoint Website 24 hours a day, any day of the year! You can also shop for more great Hotpoint products and take advantage of all of our on-line support services designed for your convenience.



Schedule Service

www.Hotpoint.com

Expert Hotpoint repair service is only one step away from your door. Get on-line and schedule your service at your convenience 24 hours any day of the year! Or call 800-GE-CARES (800-432-2737) during normal business hours.



Real Life Design Studio

www.GEAppliances.com

GE supports the Universal Design concept—products, services and environments that can be used by people of all ages, sizes and capabilities. We recognize the need to design for a wide range of physical and mental abilities and impairments. For details of GE's Universal Design applications, including kitchen design ideas for people with disabilities, check out our Website today. For the hearing impaired, please call 800-TDD-GEAC (800-833-4322).



Extended Warranties

www.GEAppliances.com

Purchase a Hotpoint extended warranty and learn about special discounts that are available while your warranty is still in effect. You can purchase it on-line anytime, or call 800-626-2224 during normal business hours. Hotpoint Consumer Home Services will still be there after your warranty expires.

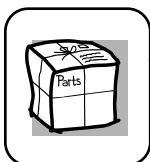

Parts and Accessories

www.Hotpoint.com

Individuals qualified to service their own appliances can have parts or accessories sent directly to their homes (VISA, MasterCard and Discover cards are accepted). Order on-line today, 24 hours every day or by phone at 800-626-2002 during normal business hours.

Instructions contained in this manual cover procedures to be performed by any user. Other servicing generally should be referred to qualified service personnel. Caution must be exercised, since improper servicing may cause unsafe operation.

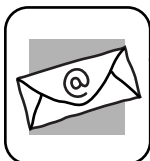

Contact Us

www.Hotpoint.com

If you are not satisfied with the service you receive from Hotpoint, contact us on our Website with all the details including your phone number, or write to: General Manager, Customer Relations
Hotpoint, Appliance Park
Louisville, KY 40225



Register Your Appliance

www.Hotpoint.com

Register your new appliance on-line—at your convenience! Timely product registration will allow for enhanced communication and prompt service under the terms of your warranty, should the need arise. You may also mail in the pre-printed registration card included in the packing material, or detach and use the form in this Owner's Manual.