

GE Monogram®

Owner's Manual

30" Convection

Wall Oven

Introduction

Your new Monogram wall oven makes an eloquent statement of style, convenience and kitchen planning flexibility. Whether you chose it for its purity of design, assiduous attention to detail—or for both of these reasons—you'll find that your Monogram wall oven's superior blend of form and function will delight you for years to come.

Your Monogram wall oven was designed to provide the flexibility to blend in with your kitchen cabinetry. Its sleek design can be beautifully integrated into the kitchen.

The information on the following pages will help you operate and maintain your wall oven properly.

Contents

Care and Cleaning

| | |
|---------------------------------|--------|
| Broiler Pan and Grid | 36 |
| Control Panel | 37 |
| Heating Elements | 37 |
| Lift-Off Oven Door | 35 |
| Light Bulb | 38 |
| Probe | 38 |
| Removable Oven Floor | 37 |
| Self-Cleaning Oven | 33, 34 |
| Shelves | 36 |
| Stainless Steel and Metal Parts | 36 |

Consumer Services

| | |
|-----------------------------|----------|
| Before You Call For Service | 39–40 |
| Important Phone Numbers | 43 |
| Model and Serial Numbers | 3 |
| Product Registration | 3, 41–42 |
| Safety Instructions | 4, 5 |
| Warranty | 44 |

Oven

| | |
|----------------------------|-----------|
| Adjust the Oven Thermostat | 32 |
| Aluminum Foil | 4, 17, 33 |
| Baking or Roasting | 16, 17 |
| Broiling/Broiling Guide | 18, 19 |
| Control, Clock and Timer | 7–12 |
| Convection Oven | 25–30 |
| Features | 6 |
| Probe | 22–24 |
| Proofing | 31 |
| Sabbath Feature | 13–15 |
| Self-Cleaning Oven | 33, 34 |
| Timed Baking | 20, 21 |

Remove packaging tape

To assure no damage is done to the finish of the product, the safest way to remove adhesive left from packaging tape on new appliances is an application of a household liquid dishwashing detergent, mineral oil or cooking oil. Apply with a soft cloth and allow to soak. Wipe dry and then apply an appliance polish to thoroughly clean and protect the surface.

NOTE: *The plastic tape must be removed from the chrome trim on the oven parts. It cannot be removed if it is baked on.*

*Before
using your
wall oven*

Read this manual carefully. It is intended to help you operate and maintain your new wall oven properly.

Keep it handy for answers to your questions.

If you don't understand something or need more help, there is a list of toll-free consumer service numbers included in the back section of this manual.

OR

Visit our Website at: www.monogram.com

*Write
down the
model &
serial
numbers*

You'll find them on a label on the front of the oven behind the oven door (on single oven models) or on the front of the lower oven behind the oven door (on double oven models).

Fill out and return the Consumer Product Registration Card that is packed with this product. If you cannot find it, please send in the duplicate card printed in the back of this manual.

Before sending in this card, please write these numbers here:

Model Number

Serial Number

Use these numbers in any correspondence or service calls concerning your wall oven.

*If you
received a
damaged
wall oven*

Immediately contact the dealer (or builder) that sold you the wall oven.

*Save time
& money*

Before you request service, check the Problem Solver in the back of this manual.

It lists causes of minor operating problems that you can correct yourself.

*If you
need
service*

To obtain service, see the Consumer Services page in the back of this manual.

We're proud of our service and want you to be pleased. If for some reason you are not happy with the service you receive, here are the steps to follow for further help.

FIRST, contact the people who serviced your appliance. Explain why you are not pleased. In most cases, this will solve the problem.

NEXT, if you are still not pleased, write all the details—including your phone number—to:

Manager, Customer Relations
GE Appliances
Appliance Park
Louisville, KY 40225

IMPORTANT SAFETY INSTRUCTIONS

WARNING!

For your safety, the information in this manual must be followed to minimize the risk of fire or explosion, electric shock, or to prevent property damage, personal injury, or loss of life.

IMPORTANT SAFETY NOTICE

- **The California Safe Drinking Water and Toxic Enforcement Act** requires the Governor of California to publish a list of substances known to the state to cause cancer, birth defects or other reproductive harm, and requires businesses to warn customers of potential exposure to such substances.
- **The fiberglass insulation in self-cleaning ovens gives off a very small amount of carbon monoxide during the cleaning cycle.** Exposure can be minimized by venting with an open window or using a ventilation fan or hood.
- **IMPORTANT:** The health of some birds is extremely sensitive to the fumes given off during the self-cleaning cycle of any oven. Move birds to another well-ventilated room.

SAFETY PRECAUTIONS

When using your appliance, follow basic safety precautions, including the following:

- Use this appliance only for its intended use as described in this manual.
- Be sure your appliance is properly installed and grounded by a qualified technician in accordance with the provided installation instructions.
- Be sure the oven is securely installed in a cabinet that is firmly attached to the house structure. Never allow anyone to climb, sit, stand or hang on the oven door.
- Have the installer show you the location of the circuit breaker or fuse. Mark it for easy reference.
- Do not attempt to repair or replace any part of your wall oven unless it is specifically recommended in this manual. All other servicing should be referred to a qualified technician.
- Teach children not to play with the controls or any other part of the oven.
- Never leave the oven door open when you are not watching the oven.
- Always keep dish towels, dish cloths, pot holders and other linens a safe distance from your oven.
- For your safety, never use your appliance for warming or heating the room.
- Always keep wooden and plastic utensils and canned food a safe distance away from your oven.
- Keep the oven free from grease buildup.
- Always keep combustible wall coverings, curtains or drapes a safe distance from your oven.
- **DO NOT STORE OR USE COMBUSTIBLE MATERIALS, GASOLINE OR OTHER FLAMMABLE VAPORS AND LIQUIDS IN THE VICINITY OF THIS OR ANY OTHER APPLIANCE.**
- Do not let cooking grease or other flammable materials accumulate in or near the wall oven.
- Do not use water on grease fires. Smother fire or flame or use a multi-purpose dry chemical or foam-type fire extinguisher.

Flame in the oven can be smothered completely by closing the oven door and turning the oven off or by using a multi-purpose dry chemical or foam-type fire extinguisher.
- Do not use aluminum foil to line oven bottoms, except as suggested in this manual. Improper installation of aluminum foil may result in a risk of electric shock or fire.
- Cook meat and poultry thoroughly—meat to at least an INTERNAL temperature of 160°F and poultry to at least an INTERNAL temperature of 180°F. Cooking to these temperatures usually protects against foodborne illness.
- Before performing any service, **DISCONNECT THE OVEN POWER SUPPLY AT THE HOUSEHOLD DISTRIBUTION PANEL BY REMOVING THE FUSE OR SWITCHING OFF THE CIRCUIT BREAKER.**
- Do not store flammable materials in the oven.

SAFETY PRECAUTIONS

- **Do not leave children alone**—children should not be left alone or unattended in an area where an appliance is in use. They should never be allowed to sit or stand on any part of the appliance.
- **Do not touch the heating elements or the interior surface of the oven.** These surfaces may be hot enough to burn even though they are dark in color. During and after use, do not touch, or let clothing or other flammable materials contact, any interior area of the oven; allow sufficient time for cooling first.

Potentially hot surfaces include the oven vent openings and surfaces near the openings, crevices around the oven door, the edges of the door window and metal trim parts above the door.

Remember: The inside surface of the oven may be hot when the door is opened.
- **CAUTION: ITEMS OF INTEREST TO CHILDREN SHOULD NOT BE STORED IN CABINETS ABOVE A WALL OVEN—CHILDREN CLIMBING ON THE OVEN TO REACH ITEMS COULD BE SERIOUSLY INJURED.**
- **Never wear loose-fitting or hanging garments while using the appliance.** Be careful when reaching for items stored over the oven. Flammable material could be ignited if brought in contact with oven heating elements and may cause severe burns.
- **Do not heat unopened food containers.** Pressure could build up and the container could burst, causing an injury.
- **Keep the oven vent unobstructed.**
- **Place the oven shelf in the desired position while the oven is cool.** If shelves must be handled when hot, do not let pot holder contact the heating elements.
- **Never leave jars or cans of fat drippings in or near your oven.**
- **Pulling out the shelf to the shelf stop is a convenience in lifting heavy foods.** It is also a precaution against burns from touching hot surfaces of the door or oven walls.
- **When using cooking or roasting bags in the oven,** follow the manufacturer's directions.
- **Do not use your oven to dry newspapers.** If overheated, they can catch on fire.
- **Do not use oven for a storage area.** Items stored in an oven can ignite.
- **Do not leave paper products, cooking utensils or food in the oven when not in use.**
- **Do not allow anyone to climb, stand or hang on the door.** They could damage the oven or cause severe personal injury.
- **Use only dry pot holders**—moist or damp pot holders on hot surfaces may result in burns from steam. Do not let pot holders touch oven heating elements. Do not use a towel or other bulky cloth.
- **After broiling, always take the broiler pan out of the oven and clean it.** Leftover grease in the broiler pan can catch fire the next time you use the pan.
- **Stand away from the oven when opening the oven door.** Hot air or steam which escapes can cause burns to hands, face and/or eyes.
- **Large scratches or impacts to glass doors can lead to broken or shattered glass.**

SELF-CLEANING OVEN

- **Do not clean the door gasket.** The door gasket is essential for a good seal. Care should be taken not to rub, damage or move the gasket.
- **Do not use oven cleaners.** No commercial oven cleaner or oven liner protective coating of any kind should be used in or around any part of the oven. Residue from oven cleaners will damage the inside of the oven when the self-clean cycle is used.
- **Clean only parts listed in this Owner's Manual.**
- **Before self-cleaning the oven,** remove the broiler pan, grid and other cookware.
- **Be sure to wipe up excess spillage before starting the self-cleaning operation.**
- **If the self-cleaning mode malfunctions,** turn the oven off and disconnect the power supply. Have it serviced by a qualified technician.

SAVE THESE INSTRUCTIONS

Features of Your Wall Oven

Wall Oven

Design information

(Not all features are on all models. Appearance may vary.)

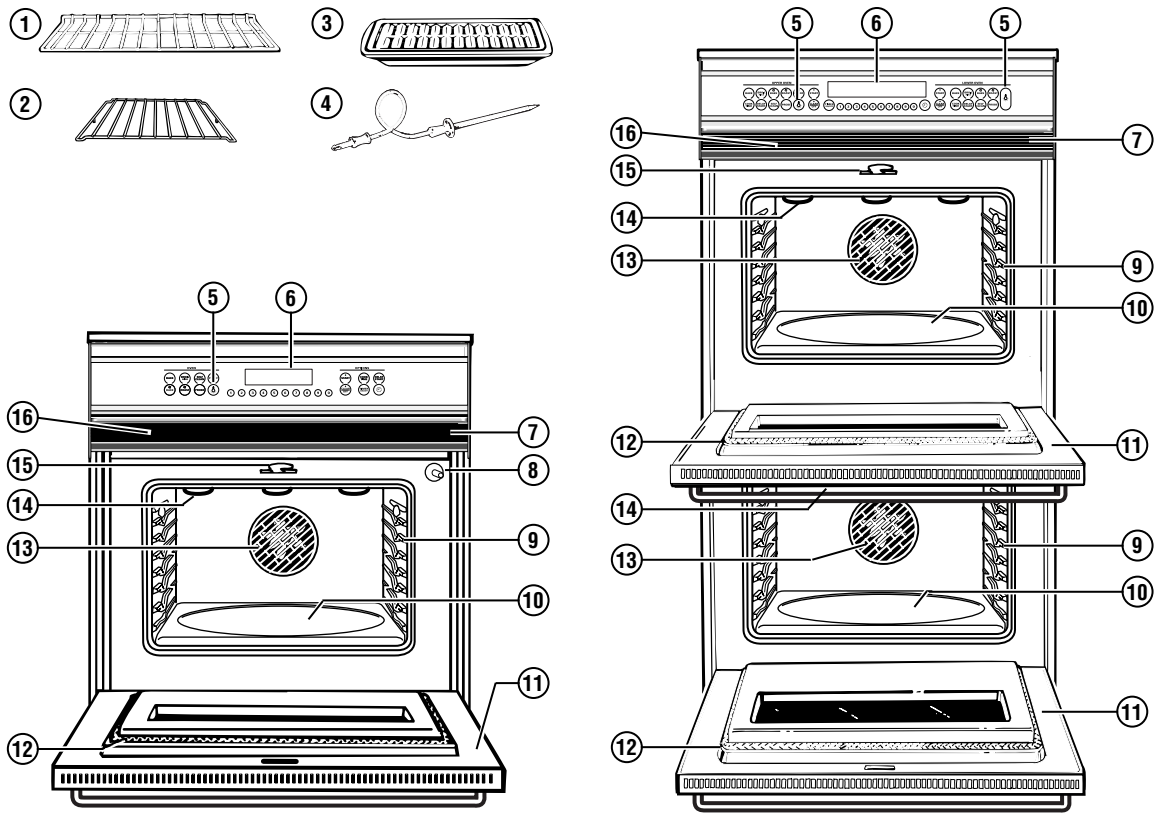

| Feature Index | Page |
|---|---------------------------|
| 1 Oven Shelves with Stop-Locks <i>Two additional shelves may be ordered. Pub No. 3-A014</i> | 5, 16, 19, 26, 33, 36 |
| 2 Roasting Rack | 25, 33, 36 |
| 3 Broiler Pan and Grid | 5, 17, 18, 23, 25, 33, 36 |
| 4 Probe <i>Depending on your oven, the probe outlet will be located in the oven wall or ceiling.</i> | 22, 24, 28, 33, 38 |
| 5 Oven Light Pad(s) <i>Lets you turn the oven light on and off. Depending on your oven, the oven light will be located in the oven wall or ceiling.</i> | 13, 33 |
| 6 Oven Control, Clock and Timer | 7-12 |
| 7 Oven Vent Grille | 5 |
| 8 Automatic Oven Light Switch <i>(on some models)</i> | — |
| 9 Oven Shelf Supports <i>Shelf positions are suggested in the Convection Cooking, Baking or Roasting and Broiling sections.</i> | 16-19, 25, 26, 28, 34, 36 |
| 10 Removable Oven Floor | 37 |
| 11 Lift-Off Oven Door with Broil Stop Position | 18, 35 |
| 12 Oven Door Gasket | 5, 35 |
| 13 Convection Fan and Heating Element <i>Operates during convection cooking.</i> | 25-30 |
| 14 Oven Broil Element | 18, 37 |
| 15 Automatic Oven Door Latch | 33, 34 |
| 16 Oven Vent | 5 |

Oven Control, Clock & Timer

Wall Oven

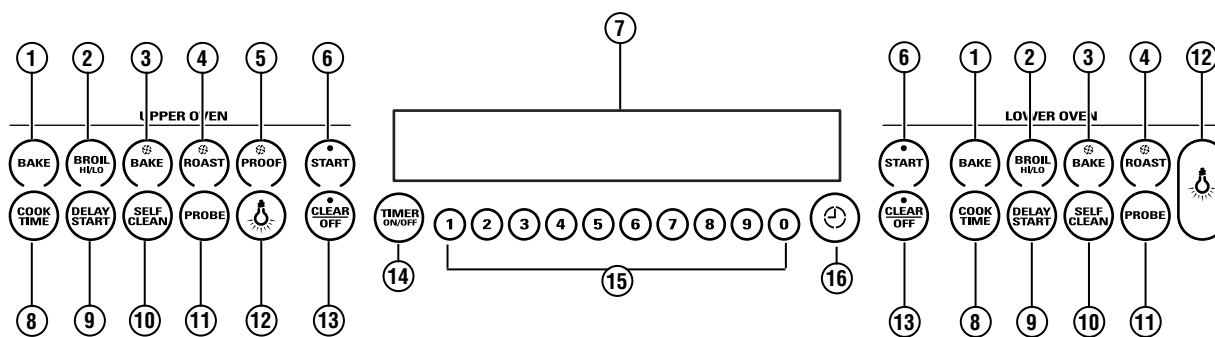

Double oven control shown. (Appearance may vary.)

Features of your oven control, clock and timer

- 1 BAKE.** Press to select the bake function.
- 2 BROIL HI/LO.** Press to select the broil function.
- 3 CONVECTION BAKE.** Press to select baking with convection.
- 4 CONVECTION ROAST.** Press to select roasting with convection.
- 5 PROOF.** Press to select a warm environment useful for rising yeast-leavened products.
- 6 START.** Must be pressed to start any cooking or cleaning function.
- 7 DISPLAY.** Shows the operations you have selected, the time of day and the cooking or cleaning status.
- 8 COOK TIME.** Use for Timed Bake, Timed Convection Bake and Timed Convection Roast operations.
- 9 DELAY START.** Use along with the **COOK TIME** or **SELF CLEAN** pads to set the oven to start and stop automatically at a time you select.
- 10 SELF CLEAN.** Press to select the self-cleaning function. See the Using the Self-Cleaning Oven section.
- 11 PROBE.** Press when using the probe to cook food.
- 12 OVEN LIGHT ON/OFF.** Press to turn the oven lights on or off.
- 13 CLEAR/OFF.** Press to cancel any oven operation except the clock and timer.
- 14 TIMER ON/OFF.** Press to select the timer function. The timer does not control oven operations. The timer can time up to 9 hours and 59 minutes.
- 15 NUMBER PADS.** Use to set any function requiring numbers—for example, the time of day on the clock, the timer, the oven temperature, the internal food temperature, the starting and length of cooking time for Timed Bake and the starting and length of cleaning time for Self-Clean.
- 16 CLOCK.** Press to enter the time of day.

If “F— and a number or letter” flash in the display and the oven control signals, this indicates function error code. Press the **CLEAR/OFF** pad. Allow oven to cool for one hour. Put the oven back into operation. If function error code repeats, disconnect power to the oven and call for service.

Tones

The control has a series of tones that will sound at different times. These tones may sound while you set the control for an oven function or at the end of the oven function. They will also alert you when an incorrect time or temperature has been entered or if there is a problem with the oven.

When you press a touch pad you will hear a beep. This beep will let you know you have placed enough pressure on the pad to activate it.

When you set an oven temperature the oven automatically starts to heat. When the temperature inside the oven reaches your set temperature a tone will sound to let you know to place the food in the oven.

An attention tone will sound if you set an invalid function or try to set an additional function. The tone can be quickly identified by watching the display messages.

Clock

The clock must be set for the automatic oven timing functions to work properly.

The time of day clock **cannot** be changed during Delay Start. (It can be changed during a regular bake or broil operation.)

To set the clock

- 1 Press the **CLOCK** pad.
- 2 Press the number pads the same way you read them. For example, to set 12:34, press the number pads 1, 2, 3 and 4 in that order.

If number pads are not pressed within one minute after you press the **CLOCK** pad, the display reverts to the original setting. If this happens, press the **CLOCK** pad and reenter the time of day.

- 3 Press the **START** pad. This enters the time and starts the clock.

To check the time of day when the display is showing other information, simply press the **CLOCK** pad. The time of day shows until another pad is pressed.

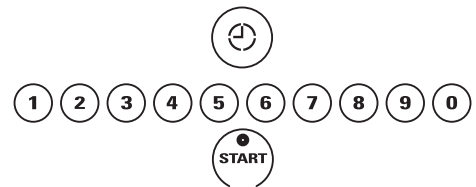

Power failure

If a flashing time of day is in the display, you have experienced a power failure. Reset the clock.

To reset the clock, press the **CLOCK** pad. Enter the correct time of day by pressing the appropriate number pads. Press the **START** pad.

Timer

NOTE: *The timer is independent of all the other functions and it does not control the oven. The CLEAR/OFF pad does not affect the timer.*

You may program the timer to time cooking or other household activities for up to 9 hours and 59 minutes.

The timer counts down in minutes, 1 minute at a time, until the last 60 seconds are reached. Then the control will beep one time. The seconds will not be displayed until the last minute is reached.

When the timer reaches “:00,” the control will beep 3 times followed by one beep every 6 seconds until the **TIMER ON/OFF** pad is pressed.

The 6 second tone can be canceled by following the steps in the Special Features of Your Control under Tones at the End of a Timed Cycle.

Using the timer

- 1 Press the **TIMER ON/OFF** pad.
- 2 Press the number pads to set the time. For example, to enter 2 hours and 45 minutes, touch 2, 4 and 5 in that order.

*If you make a mistake, press the **TIMER ON/OFF** pad and begin again.*

- 3 Press the **START** pad.

After pressing the **START** pad, “SET” disappears; this tells you the time is counting down, although the display does not change until one minute has passed.

- 4 When time is up, the oven control signals until you press the **TIMER ON/OFF** pad. Display then shows the time of day.

NOTE: *The minute timer is independent of all the other functions and it does not control the oven. The **CLEAR/OFF** pad does not affect the timer.*

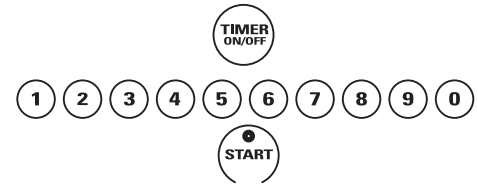

Special features of your oven control

Your new touch pad control has additional features that you may choose to use.

They remain in the control's memory until the steps are repeated. When the display shows your choice, press the **START** pad. The special features will remain in memory after a power failure, except for the Sabbath feature, which will have to be reset.

The special feature modes can only be activated while the display is showing the time of day clock.

The following are the features and how you may activate them.

Tones at the end of a timed cycle

*At the end of a timed cycle, 3 short beeps will sound followed by one beep every 6 seconds until the **CLEAR/OFF** pad is pressed. This continuous 6 second beep may be canceled. To cancel the 6 second beep:*

- 1 Press the **BAKE** and **BROIL HI/LO** pads (on double oven models use the **upper** oven controls) at the same time for 3 seconds until the display shows “SF.”
- 2 Press the **TIMER ON/OFF** pad. The display shows “CON BEEP” (continuous beep). Press the **TIMER ON/OFF** pad again. The display shows “BEEP.” (This cancels the one beep every 6 seconds.)

- 3 Press the **START** pad.

NOTE: *On double oven models this cancels the end of cycle tone for both ovens.*

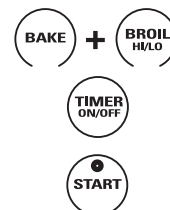

12 hour shut off

With this feature, should you forget and leave the oven on, the control will automatically turn off the oven after 12 hours during baking functions or after 3 hours during a broil function. If you wish to turn off this feature, follow the steps below.

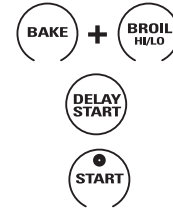

- 1 Press the **BAKE** and **BROIL HI/LO** pads (on double oven models use the **upper** oven controls) at the same time for 3 seconds until the display shows “SF.”
- 2 Press the **DELAY START** pad until “no shdn” (no shut-off) appears in the display.
- 3 Press the **START** pad to activate the no shut-off and leave the control set in this special features mode.

NOTE: On double oven models this activates this special feature in both ovens.

Cook & hold

Your new control has a cook and hold feature that keeps cooked foods warm for up to 3 hours after the cooking function is finished. To activate this feature, follow the steps below.

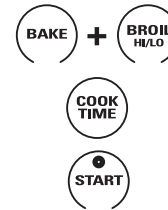

On double oven models, both ovens follow the same step 1. Then proceed with steps 2 through 3, using the pads for the upper or lower oven.

- 1 Press the **BAKE** and **BROIL HI/LO** pads (on double oven models use the **upper** oven controls) at the same time for 3 seconds until the display shows “SF.”
- 2 Press the **COOK TIME** pad. The display will show “Hld OFF.”

Press the **COOK TIME** pad again to activate the feature. The display will show “Hld ON.”
- 3 Press the **START** pad to activate the cook and hold feature and leave the control set in this special features mode.

12 hour, 24 hour or clock black-out

Your control is set to use a 12 hour clock. If you would prefer to have a 24 hour military time clock or black-out the clock display, follow the steps below.

1 Press the **BAKE** and **BROIL HI/LO** pads (on double oven models use the **upper** oven controls) at the same time for 3 seconds until the display shows “SF.”

2 Press the **CLOCK** pad once. The display will show “12 hr.” If this is the choice you want, press the **START** pad.

Press the **CLOCK** pad again to change to the 24 hour military time clock. The display will show “24 hr.” If this is the choice you want, press the **START** pad.

Press the **CLOCK** pad again to black-out the clock display. The display will show “OFF.” If this is the choice you want, press the **START** pad.

NOTE: If the clock is in the black-out mode you will not be able to use the Delay Start function.

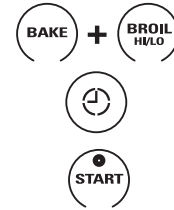

Control lockout

Your control will allow you to lock down the touch pads so they cannot be activated when pressed.

1 Press the **BAKE** and **BROIL HI/LO** pads (on double oven models use the **upper** oven controls) at the same time for 3 seconds until the display shows “SF.”

2 Press the **SELF CLEAN** pad. The display will show “LOC OFF.”

Press the **SELF CLEAN** pad again. The display will show “LOC.”

3 Press the **START** pad to activate the control lockout feature and leave the control set in this special features mode.

To unlock the control, repeat steps 1 and 2. Press the **START** pad when the display shows “LOC OFF.”

When this feature is on and the touch pads are pressed, the control will beep and the display will show “LOC.”

NOTE:

- On double oven models this activates this special feature for both ovens.
- The control lockout mode will not affect the **CLOCK**, **TIMER ON/OFF** and **OVEN LIGHT ON/OFF** touch pads.



Fahrenheit or Celsius temperature selection

Your oven control is set to use the Fahrenheit temperature selections, but you may change this to use the Celsius selections.

1 Press the **BAKE** and **BROIL HI/LO** pads (on double oven models use the **upper** oven controls) at the same time for 3 seconds until the display shows “SF.”

2 Press the **BROIL HI/LO** pad. The display will show “F” (Fahrenheit).

Press the **BROIL HI/LO** pad again. This will show “C” (Celsius).

3 Press the **START** pad. The new setting will be displayed for both ovens.

NOTE: On double oven models the new setting will be displayed for both ovens.

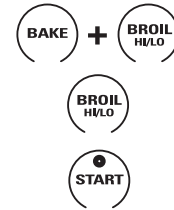

Using convection conversion

By using the Convection Conversion feature you can automatically convert the oven temperature from regular baking to Convection Bake temperatures. To convert the oven temperature for convection baking, follow the steps below.

1 Press and hold the **CONVECTION BAKE** pad for 4 to 5 seconds.

“CON Conv Bake” will show in the display.

2 Using the number pads, enter the temperature recommended in the recipe.

3 Press the **START** pad.

The display shows the converted (reduced) temperature. For example, if you entered a recipe temperature of 350°F, the display will show 325°F when it is converted.

4 Press the **CLEAR/OFF** pad when baking is finished.

NOTE: Conversion must be set each time you want to use it. It is not held in memory.

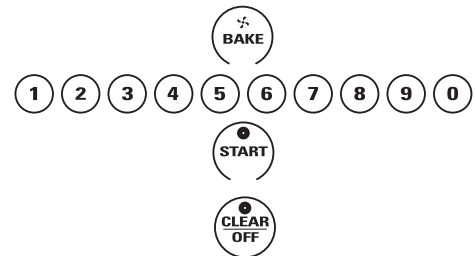

Using the Sabbath Feature

Wall Oven

Designed for use on the Jewish Sabbath and Holidays.

The Sabbath feature can be used for baking/roasting only. It cannot be used for convection, broiling, self-cleaning or Delay Start cooking.

NOTE: *The oven light comes on automatically (on some models) when the door is opened and goes off when the door is closed. The bulb may be removed. See the Oven Light Replacement section. On models with a light switch on the control panel, the oven light may be turned on and left on.*

Sabbath Feature: How to set for regular baking or roasting

Make sure the clock shows the correct time of day and the oven is OFF.

- 1 Press and hold **both** the **BAKE** and **BROIL HI/LO** pads, **at the same time**, until the display shows "SF".

NOTE: *If bake or broil appears in the display, the **BAKE** and **BROIL HI/LO** pads were not touched at the same time. Touch the **CLEAR/OFF** pad and begin again.*

- 2 Tap the **DELAY START** pad until "SAb bAtH" appears in the display.
- 3 Touch the **START** pad and \supset will appear in the display.
- 4 Touch the **BAKE** pad. No signal will be given.
- 5 Using the number pads, enter the desired temperature between 170° and 550°. No signal or temperature will be given.
- 6 Touch the **START** pad.
- 7 After a random delay period of approximately 30 seconds to 1 minute, $\supset\subset$ will appear in the display indicating that the oven is baking/roasting. If $\supset\subset$ doesn't appear in the display, start again at Step 4.

To adjust the oven temperature, touch the **BAKE** pad, enter the new temperature using the number pads, and touch the **START** pad.

NOTE: *The **CLEAR/OFF** and **COOK TIME** pads are active during the Sabbath feature.*

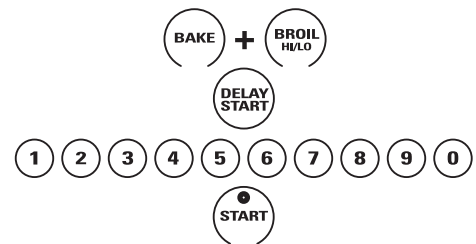

When the display shows \supset the oven is set in Sabbath. When the display shows $\supset\subset$ the oven is baking/roasting.

Sabbath Feature:

How to set for timed baking or roasting—immediate start and automatic stop

Make sure the clock shows the correct time of day and the oven is OFF.

- 1 Press and hold **both** the **BAKE** and **BROIL HI/LO** pads, **at the same time**, until the display shows “SF”.
*NOTE: If bake or broil appears in the display, the **BAKE** and **BROIL HI/LO** pads were not touched at the same time. Touch the **CLEAR/OFF** pad and begin again.*
- 2 Tap the **DELAY START** pad until “SAb bAtH” appears in the display.
- 3 Touch the **START** pad and \supset will appear in the display.
- 4 Touch the **COOK TIME** pad.
- 5 Touch the number pads to set the desired length of cooking time between 1 minute and 9 hours and 99 minutes. The cooking time that you entered will be displayed.
- 6 Touch the **START** pad.
- 7 Touch the **BAKE** pad. No signal will be given.
- 8 Using the number pads, enter the desired temperature. No signal or temperature will be given.
- 9 Touch the **START** pad.
- 10 After a random delay period of approximately 30 seconds to 1 minute, $\supset \subset$ will appear in the display indicating that the oven is baking/roasting. If $\supset \subset$ doesn't appear in the display, start again at Step 7.

To adjust the oven temperature, touch the **BAKE** pad, enter the new temperature using the number pads, and touch the **START** pad.

When cooking is finished, the display will change from $\supset \subset$ to \supset and **0:00** will appear, indicating that the oven has turned **OFF** but is still set in Sabbath. Remove the cooked food.

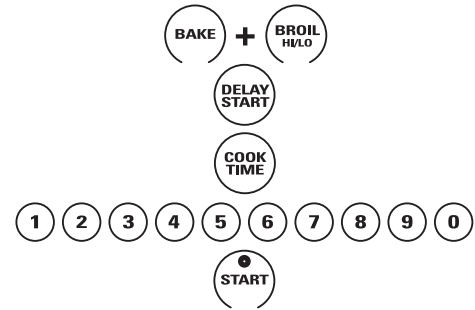

When the display shows \supset the oven is set in Sabbath. When the display shows $\supset \subset$ the oven is baking/roasting.

*How to exit
the Sabbath
feature*

- 1 Touch the **CLEAR/OFF** pad.
- 2 If the oven is cooking, wait for a random delay period of approximately 30 seconds to 1 minute, until only \supset is in the display.
- 3 Press and hold **both** the **BAKE** and **BROIL HI/LO** pads, **at the same time**, until the display shows “SF”.
- 4 Tap the **DELAY START** pad until “12 shdn” or “no shdn” appears in the display. “12 shdn” indicates that the oven will automatically turn off after 12 hours. “no shdn” indicates that the oven will not automatically turn off.
- 5 Touch the **START** pad.

***NOTE:** If a power outage occurred while the oven was in Sabbath, the oven will automatically turn off and stay off even when the power returns. The oven control must be reset.*

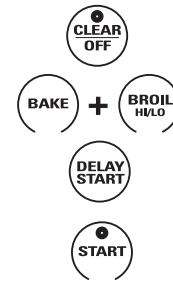

Baking or Roasting

Wall Oven

Before you begin...

To avoid possible burns, place the shelves in the desired position before you turn the oven on.

The shelves have stop-locks, so that when placed correctly on the supports, they will stop before coming completely out, and will not tilt.

When placing and removing cookware, pull the shelf out to the bump on the shelf support.

To remove a shelf, pull it toward you, tilt the front end up and pull it out.

To replace, place the end of the shelf (stop-locks) on the support, tilt up the front and push the shelf in.

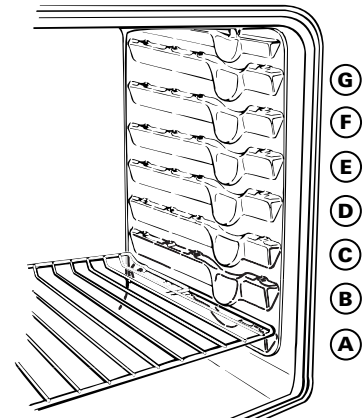

The oven has 7 shelf positions.

How to set the oven for baking or roasting

- 1 Press the **BAKE** pad.
- 2 Press the number pads to set the desired temperature.
- 3 Press the **START** pad.
- 4 Check food for doneness at minimum time on recipe. Cook longer if necessary.
- 5 Press the **CLEAR/OFF** pad when cooking is complete.

NOTE: A cooling fan may automatically turn on and off to cool internal parts. This is normal, and the fan may continue to run even after the oven is turned off.

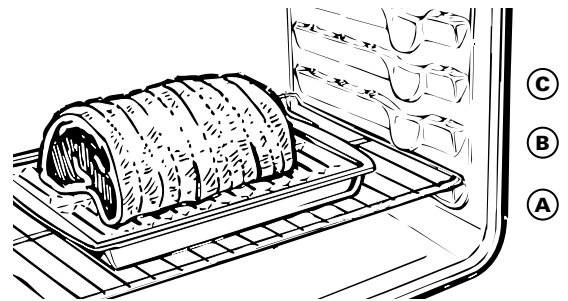

| Type of Food | Shelf Position |
|--|----------------|
| Frozen pies (on cookie sheet) | C or D |
| Angel food cake, bundt or pound cakes | B |
| Biscuits, muffins, brownies, cookies, cupcakes, layer cakes, pies | C or D |
| Casseroles | C or D |

Preheating and pan placement

Preheat the oven if the recipe calls for it. To preheat, set the oven at the correct temperature. Preheating is necessary for good results when baking cakes, cookies, pastry and breads.

For ovens without a preheat indicator light or tone, preheat 10 minutes.

Baking results will be better if baking pans are centered in the oven as much as possible. Pans should not touch each other or the walls of the oven. If you need to use two shelves, stagger the pans so one is not directly above the other, and leave approximately 1½" between pans, from the front, back and sides of the wall.

Aluminum foil

You can use aluminum foil to line the broiler pan and broiler grid. However, you must mold the foil tightly to the grid and cut slits in it just like the grid.

Aluminum foil may also be used to catch a spillover.

Never entirely cover a shelf with aluminum foil. This will disturb the heat circulation and result in poor baking.

A smaller sheet of foil may be used to catch a spillover by placing it on a lower shelf several inches below the food.

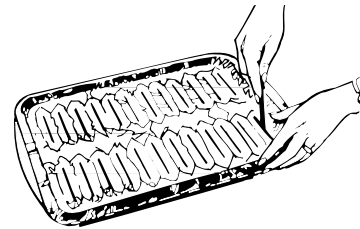

Cut slits in the foil just like the grid.

How to set the oven for broiling

- 1 Place the meat or fish on the broiler grid in the broiler pan.
- 2 Follow suggested shelf positions in the Broiling Guide.

If your oven is connected to 208 volts, rare steaks may be broiled by preheating the broiler and positioning the oven shelf one position higher.

- 3 Press the **BROIL HI/LO** pad once for **HI Broil**.

To change to **LO Broil**, press the **BROIL HI/LO** pad again.

- 4 Press the **START** pad.
- 5 When broiling is finished, press the **CLEAR/OFF** pad.

NOTE: *Broil will not work if the temperature probe is plugged in.*

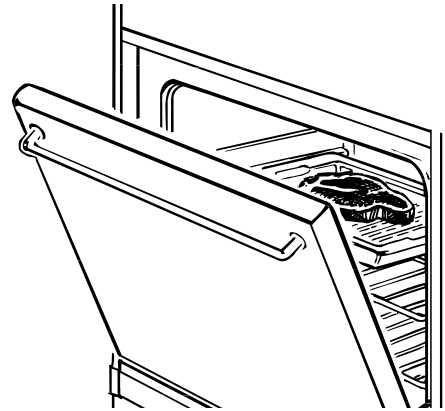

Leave the door open to the broil stop position. The door stays open by itself, yet the proper temperature is maintained in the oven.

*Broiling
guide*

| Food | Quantity and/ or Thickness | Shelf Position | First Side Time (min.) | Second Side Time (min.) | Comments |
|-----------------------------------|--|---------------------------|-----------------------------------|------------------------------------|--|
| Ground Beef | 1 lb. (4 patties) | E | 10 | 7 | Space evenly. Up to 8 patties take about the same time. |
| Well Done | 1/2 to 3/4" thick | E | 10 | 9 | |
| Beef Steaks | | | | | Steaks less than 1" thick cook through before browning. Pan frying is recommended. |
| Rare | 1" thick | E | 8 | 6 | |
| Medium | 1 to 1½ lbs. | E | 10 | 8 | |
| Well Done | | E | 12 | 10 | Slash fat. |
| Rare | 1½" thick | E | 10 | 8 | |
| Medium | 2 to 2½ lbs. | E | 15 | 14-16 | |
| Well Done | | E | 25 | 20-25 | |
| Chicken | 1 whole 2 to 2½ lbs., split lengthwise | C | 25 | 10 | Reduce time about 5 to 10 minutes per side for cut-up chicken. Brush each side with melted butter. Broil skin-side-down first. |
| Lobster Tails | 2-4 6 to 8 oz. each | C | 13-16 | Do not turn over. | Cut through back of shell. Spread open. Brush with melted butter before broiling and after half of broiling time. |
| Fish Fillets | 1/4 to 1/2" thick | E | 5 | 5 | Handle and turn very carefully. Brush with lemon butter before and during cooking, if desired. Preheat broiler to increase browning. |
| Ham Slices (precooked) | 1" thick | D | 8 | 8 | Increase time 5 to 10 minutes per side for 1½" thick or home-cured ham. |
| Pork Chops | 2 (1/2" thick) | E | 10 | 10 | Slash fat. |
| Well Done | 2 (1" thick) about 1 lb. | D | 15 | 15 | |
| Lamb Chops | | | | | Slash fat. |
| Medium | 2 (1" thick) | E | 10 | 9 | |
| Well Done | about 10 to 12 oz. | E | 12 | 10 | |
| Medium | 2 (1½" thick) | E | 14 | 12 | |
| Well Done | about 1 lb. | E | 17 | 12-14 | |

Timed Baking

Wall Oven

Using the timed baking and roasting features

NOTE: Foods that spoil easily, such as milk, eggs, fish, stuffings, poultry and pork, should not be allowed to sit for more than 1 hour before or after cooking. Room temperature promotes the growth of harmful bacteria. Be sure that the oven light is off because heat from the bulb will speed harmful bacteria growth.

On double oven models, you can use timed baking in one oven while using self-clean in the other; you can also use timed baking in both ovens at the same time.

How to set an immediate start and automatic stop

The oven will turn on immediately and cook for a selected length of time. At the end of the cooking time the oven will turn off automatically.

Make sure the oven clock shows the correct time of day.

- 1 Press the **BAKE** pad.
- 2 Using the number pads, enter the desired temperature.
- 3 Press the **COOK TIME** pad.

NOTE: If your recipe requires preheating, you may need to add additional time to the length of the cooking time.

- 4 Using the number pads, enter the desired baking time. The oven temperature and the cooking time that you entered will be displayed.

- 5 Press the **START** pad.

The display shows the oven temperature that you set and the cooking time countdown. (The display starts changing once the temperature reaches 100°F.)

NOTE: On double oven models when using both ovens at the same time, the times showing in the display will be for the last oven set. To display the time set for the first oven set, press the **COOK TIME** pad for that oven.

The oven will continue to cook for the programmed amount of time, then shut off automatically.

Press the **CLEAR/OFF** pad to clear the display.

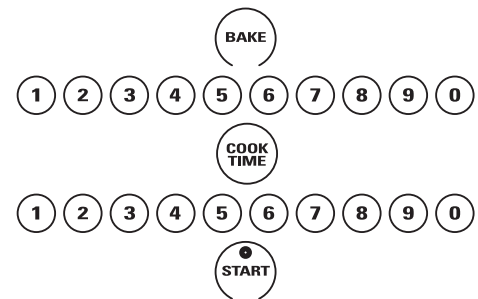

How to set a delayed start and automatic stop

You can set the oven control to delay-start the oven, cook for a specific length of time and then turn off automatically.

Make sure the oven clock shows the correct time of day.

- 1 Press the **BAKE** pad.
- 2 Using the number pads, enter the desired temperature.
- 3 Press the **COOK TIME** pad.

NOTE: If your recipe requires preheating, you may need to add additional time to the length of the cooking time.

- 4 Using the number pads, enter the desired baking time.
- 5 Press the **DELAY START** pad.
- 6 Using the number pads, enter the time of day you want the oven to turn on and start cooking.
- 7 Press the **START** pad.

NOTE: An attention tone will sound if you are using timed baking and do not press the **START** pad after entering the baking temperature.

If you would like to check the times you have set, press the **DELAY START** pad to check the start time you have set or press the **COOK TIME** pad to check the length of cooking time you have set.

When the oven turns on at the time of day you have set, the display will show the changing temperature (starting at 100°F.) and the cooking time countdown.

NOTE: On double oven models when using both ovens at the same time, the times showing in the display will be for the last oven set. To display the time set for the first oven set, press the **DELAY START** pad to check the start time you have set or press the **COOK TIME** pad to check the length of cooking time you have set.

At the end of timed baking, the oven will turn off. The end of cycle tone will sound.

Press the **CLEAR/OFF** pad to clear the display.

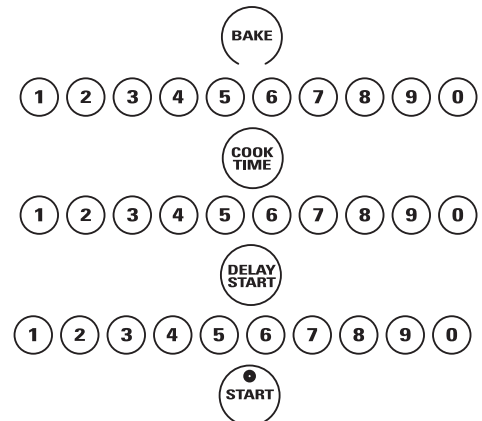

Temperature probe

NOTE: Double oven models have a probe in the upper oven only.

For many foods, especially roasts and poultry, internal food temperature is the best test for doneness. The temperature probe takes the guesswork out of roasting by cooking foods to the exact doneness you want.

Use of probes other than the one provided with this product may result in damage to the probe.

Use the handles of the probe and plug when inserting and removing them from the meat and outlet.

- To avoid damaging your probe, do not use tongs to pull on the cable when removing it.
- To avoid breaking the probe, make sure food is completely defrosted before inserting.
- To prevent possible burns, do not unplug the probe from the outlet until the oven has cooled.
- Never leave your probe inside the oven during a self-cleaning cycle.
- Do not store the probe in the oven.

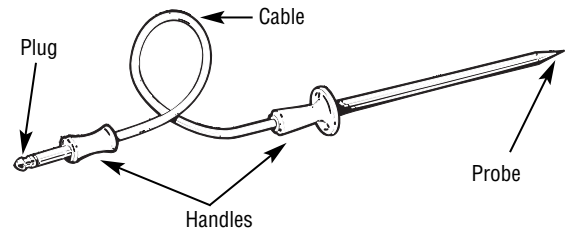

The temperature probe has a skewer-like probe at one end and a plug at the other end that goes into the outlet in the oven.

*Proper
placement
of the probe*

After preparing the meat and placing it on a trivet or on the broiler pan grid, follow these directions for proper probe placement.

1 Lay the probe on the outside of the meat along the top or side and mark with your finger where the edge of the meat comes to on the probe. The point should rest in the center of the thickest meaty part of the roast.

2 Insert the probe completely into the meat. It should not touch the bone, fat or gristle.

For roasts with no bone, insert the probe into the meatiest part of the roast. For bone-in ham or lamb, insert the probe into the center of the lowest large muscle or joint.

Insert the probe into the center of dishes such as meat loaf or casseroles. When cooking fish, insert the probe from just above the gill into the meatiest area, parallel to the backbone.

Insert the probe into the meatiest part of the inner thigh from below and parallel to the leg of a whole turkey.

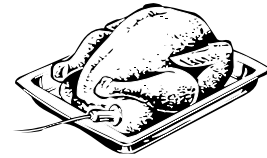
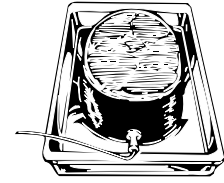

Using the Probe

Wall Oven

How to set the oven for roasting when using the probe

- 1 Insert the probe into the meat.
- 2 Plug the probe into the outlet in the oven.
Make sure it is pushed all the way in.
Close the oven door.
- 3 Press the **PROBE** pad.
- 4 Press the number pads to set the desired internal food or meat temperature.
- 5 Press the **BAKE** pad.
- 6 Press the number pads to set the desired oven temperature.
- 7 Press the **START** pad.

The display will flash if the probe is inserted into the outlet and you have not set a probe temperature and pressed the START pad.

When the oven starts to heat, the word LO will be in the display.

After the internal temperature of the meat reaches 100°F, the changing internal temperature will be shown in the display.

- 8 When the internal temperature of the meat reaches the number you have set, the probe and the oven turn off and the oven control signals. To stop the signal, press the **CLEAR/OFF** pad. Use hot pads to remove the probe from the food. Do not use tongs to pull on it—they might damage it.

To change the oven temperature during the Roast cycle, press the **BAKE** pad and then the number pads to set the new temperature.

- If the probe is removed from the food before the final temperature is reached, a tone will sound and the display will flash until the probe is removed from the oven.
- You can use the timer even though you cannot use timed oven operations.

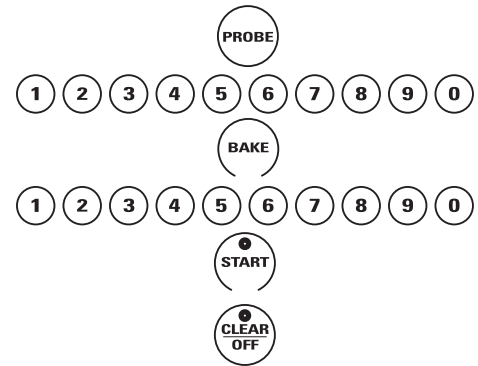
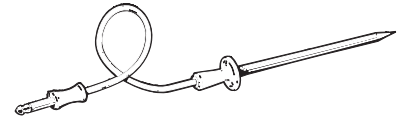

Using the Convection Oven

Wall Oven

Convection fan

In a convection oven, a fan circulates hot air over, under and around the food.

This circulating hot air is evenly distributed throughout the oven cavity. As a result, foods are evenly cooked and browned—often in less time with convection heat.

The convection fan shuts off when the oven door is opened. DO NOT leave the door open for long periods of time while using convection cooking or you may shorten the life of the convection heating element.

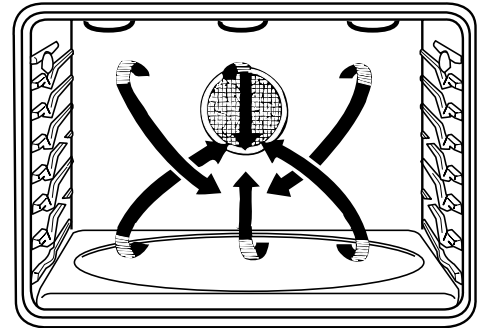

(Appearance may vary.)

Convection baking

Heat comes from the heating element in the rear of the oven. The convection fan circulates the heated air evenly over and around the food. Preheating is not necessary with foods having a bake time of over 15 minutes.

- Ideal for evenly browned baked foods cooked on multiple shelves.
- Good for large quantities of baked foods.
- Good results with cookies, biscuits, muffins, brownies, cupcakes, cream puffs, sweet rolls, angel food cake and bread.

Convection roasting

- Good for large tender cuts of meat, uncovered.

Heat comes from the top heating element. The convection fan circulates the heated air evenly over and around the food. Meat and poultry are browned on all sides as if they were cooked on a rotisserie. Using the roasting rack provided, heated air will be circulated over, under and around the food being roasted. The heated air seals in juices quickly for a moist and tender product while, at the same time, creating a rich golden brown exterior.

Roasts or poultry should be cooked on a shelf in the lowest shelf position (A).

When you are convection roasting it is important that you use the broiler pan and grid and the special roasting rack for best convection roasting results. The pan is used to catch grease spills and the grid is used to prevent grease splatters.

Place the meat on the special roasting rack. The rack holds the meat. The rack allows the heated air to circulate under the meat and increase browning on the underside of the meat or poultry.

- Place the shelf in the lowest shelf position (A).
- Place the grid on the broiler pan and put the roasting rack over them making sure the posts on the roasting rack fit into the holes in the broiler pan.

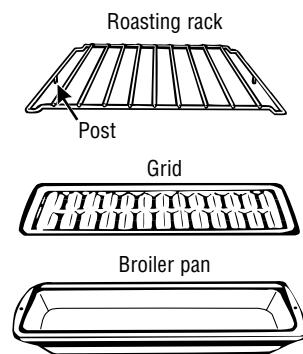

Using the Convection Oven

Wall Oven

Adapting recipes

You can use your favorite recipes in the convection oven.

When baking, reduce baking temperature by 25°F.

No need to preheat when cooking longer than 15 minutes.

Use pan size recommended.

Some package instructions for frozen casseroles or main dishes have been developed using commercial convection ovens. For best results in this oven, preheat the oven and use the temperature on the package.

Multi-shelf baking

When convection baking with only 1 shelf, follow the shelf positions recommended in the Baking or Roasting section.

Because heated air is circulated evenly throughout the oven, foods can be baked with excellent results using multiple shelves.

Multi-shelf baking may increase cook times slightly for some foods but the overall result is time saved. Cookies, muffins, biscuits and other quickbreads give very good results with multi-shelf baking.

When baking on 3 shelves, place one shelf in the bottom (A) position, one on the third (C) position and one in the fifth (E) shelf position.

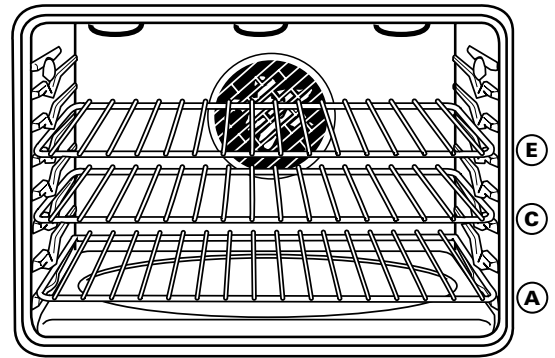

Multi-shelf position

Cookware for convection cooking

Before using your convection oven, check to see if your cookware leaves room for air circulation in the oven. If you are baking with several pans, leave space between them. Also, be sure the pans do not touch each other or the walls of the oven.

Paper and Plastic

Heat-resistant paper and plastic containers that are recommended for use in regular ovens can be used in convection ovens. Plastic cookware that is heat-resistant to temperatures of 400°F can also be used.

Metal and Glass

Any type of cookware will work in your convection oven. However, metal pans heat the fastest and are recommended for convection baking.

Darkened or matte-finished pans will bake faster than shiny pans.

Glass or ceramic pans cook more slowly.

When baking cookies, you will get the best results if you use a flat cookie sheet instead of a pan with low sides.

For recipes like oven-baked chicken, use a pan with low sides. Hot air cannot circulate well around food in a pan with high sides.

How to set the oven for convection baking or roasting

To avoid possible burns, place the shelves in the correct position before you turn on the oven.

- 1 Press the **CONVECTION BAKE** or **CONVECTION ROAST** pad.
- 2 Press the number pads to set the desired oven temperature.
- 3 Press the **START** pad.

To change the oven temperature, press the **CONVECTION BAKE** or **CONVECTION ROAST** pad and then the number pads to set the new temperature.

When the oven starts to heat, the changing temperature, starting at 100°F, will be displayed. When the oven reaches the temperature you set, 3 beeps will sound.

- 4 Press the **CLEAR/OFF** pad when finished.

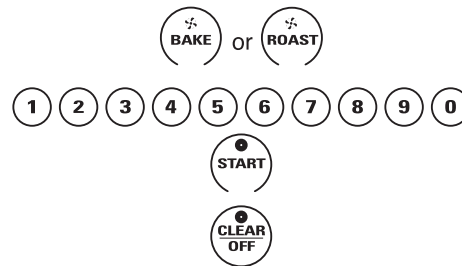

NOTE:

- You will hear a fan while cooking with convection. The fan will stop when the door is opened but the heat will not turn off.
- You may hear the oven clicking during baking. This is normal.

Convection roasting guide

| Meats | | Minutes/Lb. | Oven Temp. | Internal Temp. |
|----------------|--|--|-------------------------|--------------------------|
| Beef | Rib, Boneless Rib, Top Sirloin (3 to 5 lbs.) | Rare 20–24 Medium 24–28 Well 28–32 | 325°F 325°F 325°F | 140°F† 160°F 170°F |
| | Beef Tenderloin | Rare 10–14 Medium 14–18 | 325°F 325°F | 140°F† 160°F |
| | Pork | Bone-in, Boneless (3 to 5 lbs.) | 23–27 | 325°F |
| | Chops (1/2 to 1" thick) | 2 chops 30–35 total 4 chops 35–40 total 6 chops 40–45 total | 325°F 325°F 325°F | 170°F 170°F 170°F |
| Ham | Canned, Butt, Shank (3 to 5 lbs.) (fully cooked) | 14–18 | 325°F | 140°F |
| Lamb | Bone-in, Boneless (3 to 5 lbs.) | Medium 17–20 Well 20–24 | 325°F 325°F | 160°F 170°F |
| Seafood | Fish, whole (3 to 5 lbs.) | 30–40 total | 400°F | |
| | Lobster Tails (6 to 8 oz. each) | 20–25 total | 350°F | |
| Poultry | Whole Chicken (2½ to 3½ lbs.) | 24–26 | 350°F | 180°–185°F |
| | Cornish Hens Unstuffed (1 to 1½ lbs.) | 50–55 total | 350°F | 180°–185°F |
| | Stuffed (1 to 1½ lbs.) | 55–60 total | 350°F | 180°–185°F |
| | Duckling (4 to 5 lbs.) | 24–26 | 325°F | 180°–185°F |
| | Turkey, whole* | Unstuffed (10 to 16 lbs.) 8–11 Unstuffed (18 to 24 lbs.) 7–10 | 325°F 325°F | 180°–185°F 180°–185°F |
| | Turkey Breast (4 to 6 lbs.) | 16–19 | 325°F | 170°F |

* Stuffed birds generally require 30–45 minutes additional roasting time. Shield legs and breast with foil to prevent over-browning and drying of skin.

† The U.S. Department of Agriculture says “Rare beef is popular, but you should know that cooking it to only 140°F means some food poisoning organisms may survive.” (Source: Safe Food Book. Your Kitchen Guide. USDA Rev. June 1985.)

How to set the oven for convection roasting when using the probe

CAUTION: To prevent possible burns, do not unplug the probe from the oven outlet until the oven has cooled. Do not store the probe in the oven.

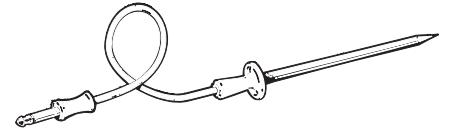

For best results when roasting large turkeys and roasts, we recommend using the probe included in the convection oven.

- 1 Place the shelf in the lowest position (A). Insert the probe into the meat.
- 2 Plug the probe into the outlet in the oven. Make sure it is pushed all the way in. Close the oven door.
- 3 Press the **CONVECTION ROAST** pad.
- 4 Press the number pads to set the desired oven temperature.

To change the oven temperature during the Convection Roast cycle, press the **CONVECTION ROAST** pad and then press the number pads to set the new desired temperature.

- 5 Press the **PROBE** pad.
- 6 Press the number pads to set the desired internal meat temperature.
- 7 Press the **START** pad.

The display will flash **PROBE** and the oven control will signal if the probe is inserted into the outlet, and you have not set a probe temperature and pressed the **START** pad.

When the oven starts to heat, the word **LO** will be in the display.

After the internal temperature of the meat reaches 100°F., the changing internal temperature will be shown in the display.

- 8 When the internal temperature of the meat reaches the number you have set, the probe and the oven turn off and the oven control signals. To stop the signal, press the **CLEAR/OFF** pad. Use hot pads to remove the probe from the food. Do not use tongs to pull on it—they might damage it.

If the probe is removed from the food before the final temperature is reached, a tone will sound and the display will flash until the probe is removed from the oven.

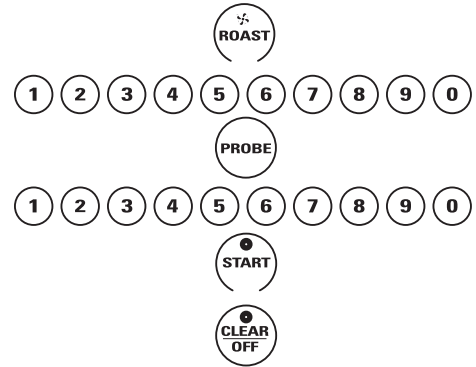

NOTE:

- You will hear a fan while cooking with this feature. The fan will stop when the door is opened but the heat will not turn off.
- You can use the timer even though you cannot use timed oven operations.
- On double oven models, you will not be able to use the probe in the upper oven during timed oven operations. This is because with the probe you are cooking by temperature rather than time.

Timed Convection Baking

Wall Oven

Using the features for convection baking

NOTE: Foods that spoil easily, such as milk, eggs, fish, stuffings, poultry and pork, should not be allowed to sit for more than 1 hour before or after cooking. Room temperature promotes the growth of harmful bacteria. Be sure that the oven light is off because heat from the bulb will speed harmful bacteria growth.

On double oven models, you can use timed baking in one oven while using self-clean in the other; you can also use timed baking in both ovens at the same time.

How to set an immediate start and automatic stop

The oven will turn on immediately and cook for a selected length of time. At the end of the cooking time, the oven will turn off automatically.

Make sure the oven clock shows the correct time of day.

- 1 Press the **CONVECTION BAKE** pad.
- 2 Press the number pads to set the desired oven temperature.
- 3 Press the **COOK TIME** pad.

NOTE: If your recipe requires preheating, you may need to add additional time to the length of the cooking time.

- 4 Press the number pads to set the desired length of cooking time. The minimum cooking time you can set is 1 minute.

The oven temperature that you set and the cooking time that you entered will be in the display.

- 5 Press the **START** pad.

The display shows the oven temperature that you set and the cooking time countdown. (The display starts changing once the temperature reaches 100°F.)

NOTE: On double oven models when using both ovens at the same time, the times showing in the display will be for the last oven set. To display the time set for the first oven set, press the **COOK TIME** pad for that oven.

- 6 At the end of timed convection bake, the oven will turn off. The end of cycle tone will sound. Press the **CLEAR/OFF** pad to clear the display if necessary.
- 7 Remove the food from the oven. Remember, foods that are left in the oven continue cooking after the controls are off.

NOTE: You will hear a fan while cooking with this feature. The fan will stop when the door is opened but the heat will not turn off.

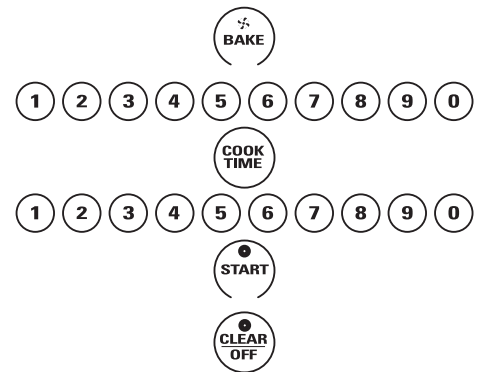

How to set a delayed start and automatic stop

You can set the oven control to delay-start the oven, cook for a specific length of time and then turn off automatically.

Make sure the oven clock shows the correct time of day.

- 1 Press the **CONVECTION BAKE** pad.
- 2 Press the number pads to set the desired oven temperature.
- 3 Press the **COOK TIME** pad.

NOTE: If your recipe requires preheating, you may need to add additional time to the length of the cooking time.

- 4 Press the number pads to set the desired cooking time.
- 5 Press the **DELAY START** pad.
- 6 Press the number pads to set the time of day you want the oven to turn on and start cooking.

If you would like to check the times you have set, press the **DELAY START** pad to check the start time you have set or press the **COOK TIME** pad to check the length of cooking time you have set.

- 7 Press the **START** pad.

NOTE: An attention tone will sound if you are using timed baking and do not press the **START** pad after entering the baking temperature.

When the oven turns on at the time of day you have set, the display will show the changing temperature (starting at 100°F) and the cooking time countdown.

NOTE: On double oven models when using both ovens at the same time, the times showing in the display will be for the last oven set. To display the time set for the first oven set, press the **DELAY START** pad to check the start time you have set or press the **COOK TIME** pad to check the length of cooking time you have set.

At the end of timed convection bake the oven will turn off. The end of cycle tone will sound.

- 8 Press the **CLEAR/OFF** pad to clear the display if necessary. When baking is finished, remove the food from the oven. Remember, even though the oven shuts off automatically, foods continue cooking after the controls are off.

NOTE: You will hear a fan while cooking with this feature. The fan will stop when the door is opened but the heat will not turn off.

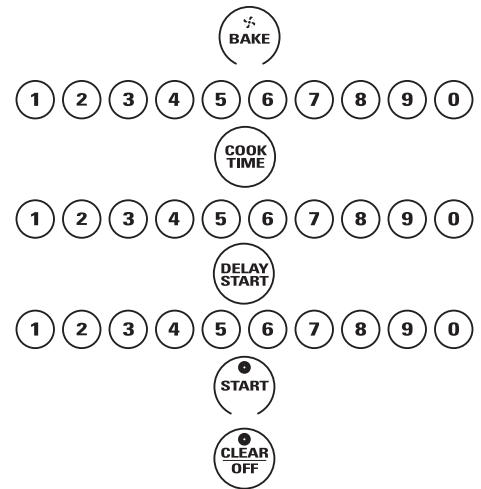

How to set the oven for proofing

The proofing feature maintains a warm environment useful for rising yeast-leavened products.

- 1 Place the covered dough in a dish in the oven on shelf **B** or **C**.

NOTE: For best results, cover the dough with a cloth or with greased plastic wrap (the plastic may need to be anchored underneath the container so the oven fan will not blow it off).

- 2 Press the **PROOF** pad and then the **START** pad.

The display will read “BRD” (bread).

The oven interior light turns on and remains on during proofing.

The proofing feature automatically provides the desired temperature for proofing and therefore does not have a temperature adjustment.

- 3 Set the **TIMER ON/OFF** for a maximum of 1 hour. Depending upon the recipe, bread may complete proofing in less than 1 hour. Check bread as needed for progress.

- 4 After 1 hour of proofing, press the **CLEAR/OFF** pad. If proofing is not complete, leave the bread in the closed oven until it reaches the desired height.

- To avoid lowering the oven temperature and lengthening proofing time, do not open the oven door unnecessarily.
- Check bread products early to avoid over-proofing.

NOTE:

- Do not use the proofing mode for warming food or keeping food hot. The proofing oven temperature is not hot enough to hold foods at safe temperatures.
- Proofing feature on upper oven only.
- Proofing will not operate when oven is above 150°F. “HOT” will show in the display.



NOTE:

Set the oven to **PROOF** for a maximum of 1 hour, then leave the bread in the closed oven until it reaches the desired height. Using **PROOF** in excess of 1 hour may kill the yeast.

Adjust the Oven Thermostat

Wall Oven

Do it yourself!

You may find that your new oven cooks differently than the one it replaced. Use your new oven for a few weeks to become more familiar with it. If you still think your new oven is too hot or too cold, you can adjust the thermostat yourself.

Do not use thermometers, such as those found in grocery stores, to check the temperature setting of your oven. These thermometers may vary 20–40 degrees.

NOTE: This adjustment will not affect the broiling or the self-cleaning temperatures. The adjustment will be retained in memory after a power failure.

To adjust the oven thermostat

- 1 Press the **BAKE** and **BROIL HI/LO** pads at the same time for 3 seconds until the display shows “SF.”
- 2 Press the **BAKE** pad of the oven which you want to adjust the oven thermostat. A two digit number shows in the display.
Press **BAKE** once to decrease (-) the oven temperature, or twice to increase (+).
- 3 The oven temperature can be adjusted up to (+) 35°F hotter or (-) 35°F cooler. Press the number pads the same way you read them. For example, to change the oven temperature 15°F, press 1 and 5.
- 4 When you have made the adjustment, press the **START** pad to go back to the time of day display. Use your oven as you would normally.

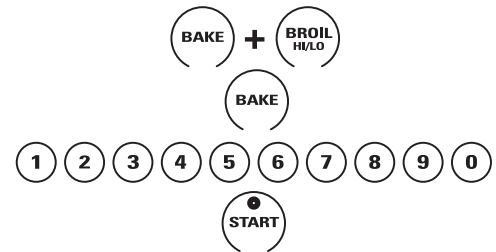

The type of margarine will affect baking performance!

Most recipes for baking have been developed using high fat products such as butter or margarine (80% fat). If you decrease the fat, the recipe may not give the same results as with a higher fat product.

Recipe failure can result if cakes, pies, pastries, cookies or candies are made with low fat spreads. The lower the fat content of a spread product, the more noticeable these differences become.

Federal standards require products labeled “margarine” to contain at least 80% fat by weight. Low fat spreads, on the other hand, contain less fat and more water. The high moisture content of these spreads affect the texture and flavor of baked goods. For best results with your old favorite recipes, use margarine, butter or stick spreads containing at least 70% vegetable oil.

Using the Self-Cleaning Oven

Wall Oven

Before a clean cycle

The oven door must be closed and all controls must be set correctly for the cycle to work properly.

The oven must be cool in order to set the self-clean cycle.

We recommend venting your kitchen with an open window or using a ventilation fan or hood during the first self-clean cycle.

Remove the broiler pan, broiler grid, probe, all cookware and any aluminum foil from the oven.

The oven shelves and convection roasting rack can be self-cleaned, but they will darken, lose their luster and become hard to slide.

Do not use abrasives or oven cleaners. Clean the top, sides and outside of the oven door with soap and water.

Make sure the oven light bulb cover (on some models) is in place and the oven light is off.

IMPORTANT: The health of some birds is extremely sensitive to the fumes given off during the self-cleaning cycle of any oven. Move birds to another well ventilated room.

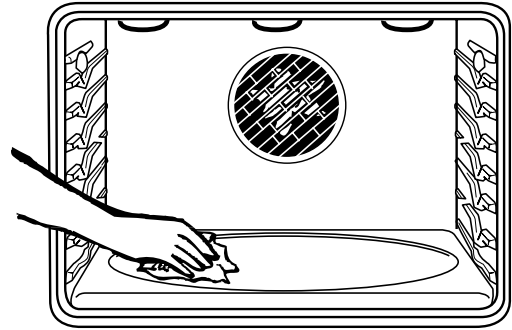

Wipe up heavy soil on the oven bottom.
(Appearance may vary.)

On double oven models, you can set a clean cycle in both ovens at the same time. The last oven set will automatically delay its start until the end of the first oven's clean cycle.

On double oven models, you can use timed baking in one oven and self-clean the other at the same time.

How to set the oven for cleaning

- 1 Press the **SELF CLEAN** pad.
- 2 Using the number pads, enter the desired clean time, if a time other than 4 hours is needed.

Clean cycle time is normally 4 hours. You can change the clean time to any time between 3 hours and 5 hours, depending on how dirty your oven is.

- 3 Press the **START** pad.

The door locks automatically. The display will show the clean time remaining. It will not be possible to open the oven door until the temperature drops below the lock temperature and the **LOCKED** light goes off.

When the **LOCKED** light is off, open the door.

- The word **LOCK** will flash and the oven control will signal if you set the clean cycle and forget to close the oven door.
- To stop a clean cycle, press the **CLEAR/OFF** pad. When the **LOCKED** light goes off indicating the oven has cooled below the locking temperature, open the door.

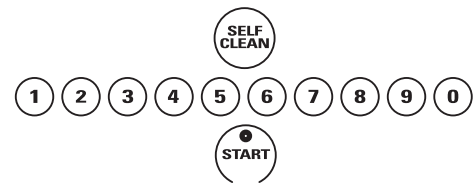

Using the Self-Cleaning Oven

Wall Oven

How to delay the start of cleaning

- 1 Press the **SELF CLEAN** pad.
- 2 Using the number pads, enter the desired clean time.
- 3 Press the **DELAY START** pad.
- 4 Using the number pads, enter the time of day you want the clean cycle to start.
- 5 Press the **START** pad.

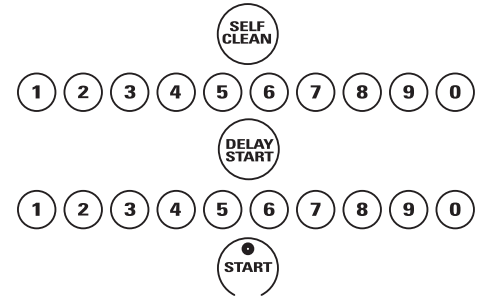

The door locks automatically. The display will show the start time. It will not be possible to open the oven door until the temperature drops below the lock temperature and the LOCKED light goes off.

When the LOCKED light is off, open the door.

NOTE: On double oven models, you can set a delay clean in both ovens at the same time. The second oven set will automatically delay the start of cleaning until the end of the first oven's clean cycle.

To recall the start time of the second oven set, press the DELAY START pad on the controls for the second oven.

After a clean cycle

You may notice some white ash in the oven. Wipe it up with a damp cloth after the oven cools.

If white spots remain, remove them with a soap-filled steel wool pad and rinse thoroughly with a vinegar and water mixture.

These deposits are usually a salt residue that cannot be removed by the clean cycle.

If the oven is not clean after one clean cycle, repeat the cycle.

- You cannot set the oven for cooking until the oven is cool enough for the door to unlock.
- While the oven is self-cleaning, you can press the **CLOCK** pad to display the time of day. To return to the clean countdown, press the **COOK TIME** pad.
- If the shelves become hard to slide, wipe the shelf supports with cooking oil.

BE SURE ELECTRICAL POWER IS OFF AND ALL SURFACES ARE COOL BEFORE CLEANING ANY PART OF THE OVEN.

Lift-off oven door— removal

The oven door is removable for easier access to the light bulb.

Do not lift the door by the handle.

To remove the door, open it to the broil stop position. Grasp firmly on each side and lift the door straight up and off the hinges.

Do not place hands between the hinge and the oven door frame.

To replace the door, make sure the hinges are in the broil stop position. Position the slots in the bottom of the door squarely over the hinges and slowly lower it over both hinges.

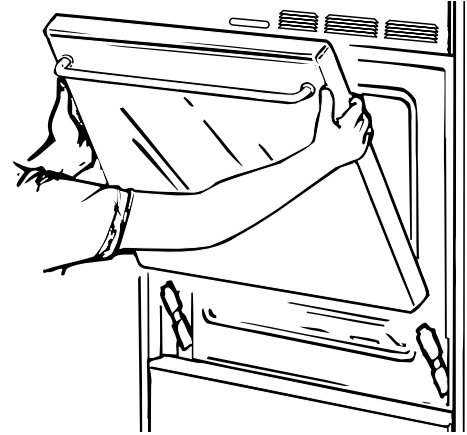

Lift the door straight up and off the hinges.

Oven door

To clean the inside of the door:

- Because the area inside the gasket is cleaned during the self-clean cycle, you do not need to clean this by hand.
- The area outside the gasket and the front frame can be cleaned with a soap-filled steel wool or plastic pad, hot water and detergent. Rinse well with a vinegar and water solution.

To clean the outside of the door:

- Use soap and water to thoroughly clean the top, sides and front of the oven door. Rinse well. You may also use a glass cleaner to clean the glass on the outside of the door. Do not let water drip into the vent openings.
- Spillage of marinades, fruit juices, tomato sauces and basting materials containing acids may cause discoloration and should be wiped up immediately. When surface is cool, clean and rinse.
- Do not use oven cleaners, cleaning powders or harsh abrasives on the outside of the door.

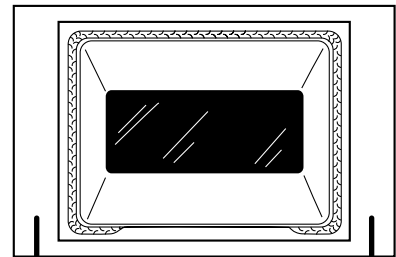

The gasket is designed with a gap at the bottom to allow for proper air circulation.

Do not rub or clean the door gasket—it has an extremely low resistance to abrasion.

If you notice the gasket becoming worn, frayed or damaged in any way or if it has become displaced on the door, you should have it replaced.

Oven shelves and convection roasting rack

Clean the oven shelves and the convection roasting rack with an abrasive cleanser or steel wool. After cleaning, rinse the shelves and rack with clean water and dry with a clean cloth.

NOTE: *The oven shelves and convection roasting rack may be cleaned in the self-cleaning oven. However, the shelves will darken in color, lose their luster and become hard to slide if cleaned during the self-cleaning cycle. You can wipe the shelf supports with cooking oil after self-cleaning to make the shelves slide more easily.*

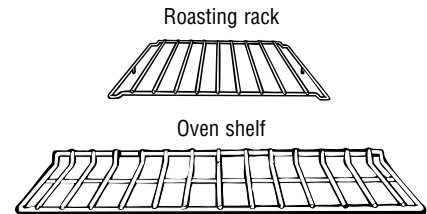

Stainless steel (on some models) & metal parts

Do not use a steel-wool pad; it will scratch the surface.

To clean the stainless-steel surface, use warm sudsy water, a stainless-steel cleaner such as Kleen King®, or an all-purpose liquid or spray cleaner. Always scrub in the direction of the grain. Rinse thoroughly with a sponge or cloth and clean water. Dry with a soft, clean cloth.

After cleaning, use a stainless-steel polish, such as Stainless Steel Magic®, Revere Copper and Stainless Steel Cleaner®, or Wenol All Purpose Metal Polish®. Follow the product instructions for cleaning the stainless-steel surface.

Broiler pan and grid

After broiling, remove the broiler pan from the oven. Remove the grid from the pan. Carefully pour out the grease from the pan into a proper container.

Wash and rinse the broiler pan and grid in hot water with a soap-filled or plastic scouring pad.

If food has burned on, sprinkle the grid with detergent while hot and cover with wet paper towels or a dishcloth. Soaking the pan will remove burned-on foods.

Both the broiler pan and grid may be cleaned with a commercial oven cleaner.

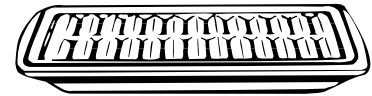

Both the broiler pan and grid can also be cleaned in a dishwasher.

Do not clean the broiler pan or grid in a self-cleaning oven.

Do not store a soiled broiler pan and grid anywhere in the oven.

Control panel

It's a good idea to wipe the control panel after each use. Clean with mild soap and water or vinegar and water, rinse with clean water and polish dry with a soft cloth.

Do not use abrasive cleansers, strong liquid cleansers, plastic scouring pads or oven cleansers on the control panel—they will damage the finish. A 50/50 solution of vinegar and hot water works well.

Removable oven floor

To remove the oven floor:

- 1 Remove the oven door using the instructions in the Lift-Off Oven Door section of this manual.
- 2 Press down and pull out the removable oven floor.

3 Clean the oven floor with warm soapy water.

4 When re-installing the oven floor be sure to slide it all the way to the back of the oven.

CAUTION: Always replace the removable floor before the next use.

Oven heating elements

Do not clean the broil element. Any soil will burn off when the element is heated.

The bake element is not exposed and is under the removable oven floor. If spillovers, residue or ash accumulate on the removable oven floor, wipe up before self-cleaning.

To clean the oven floor, take out the removable floor and gently lift the bake element. Clean with warm soapy water. Always replace the removable floor before next use.

Oven light bulbs

NOTE: The glass cover (on some models) should be removed only when cold. Wearing latex gloves may offer a better grip.

CAUTION: Before replacing the bulb, disconnect electrical power to the oven at the main fuse or circuit breaker panel.

Be sure to let the light cover and bulb cool completely.

For your safety, do not touch a hot bulb with bare hands or a damp cloth.

To remove:

- 1 Turn the glass cover counterclockwise 1/4 turn until the tabs of the glass cover clear the grooves of the socket.
- 2 Using gloves or a dry cloth, remove the bulb by pulling it straight out.

To replace:

- 1 Use a new 130-volt Halogen bulb, not to exceed 50 watts.
- 2 Using gloves or a dry cloth, remove the bulb from its packaging. Do not touch the bulb with bare fingers.
- 3 Push the bulb straight into the receptacle all the way.
- 4 Place the tabs of the glass cover into the grooves of the socket. Turn the glass cover clockwise 1/4 turn.

For improved lighting inside the oven, clean the glass cover frequently using a wet cloth. This should be done when the oven is completely cool.

- 5 Reconnect electrical power to the oven.

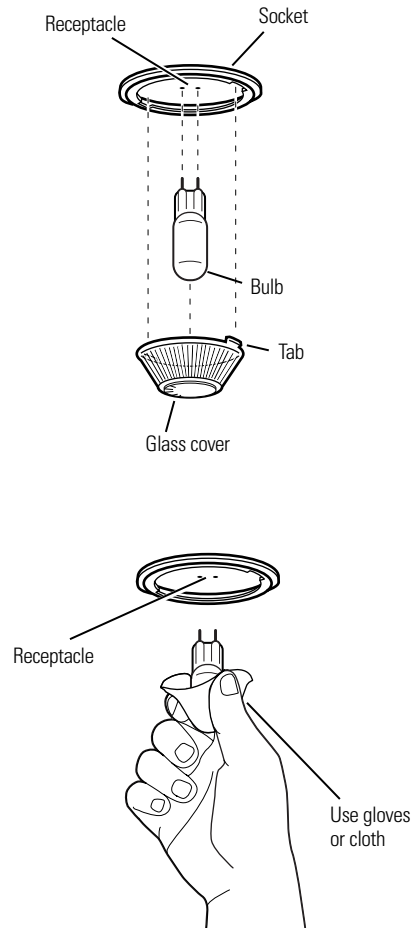

Probe

The temperature probe may be cleaned with soap and water or a soap-filled scouring pad. Cool the temperature probe before cleaning. Scour stubborn spots with a soap-filled scouring pad, rinse and dry.

Do not immerse the temperature probe in water.

Do not store the temperature probe in the oven.

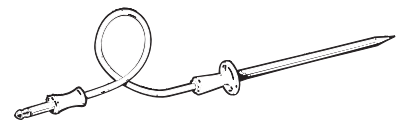

Before You Call For Service...

Wall Oven

Save time & money!

Review the troubleshooting tips on the following pages first and you may not need to call for service.

| PROBLEM | POSSIBLE CAUSE |
|---|--|
| CLOCK AND TIMER DO NOT WORK | <ul style="list-style-type: none"> • A fuse in your home may be blown or the circuit breaker tripped. Replace the fuse or reset the circuit breaker. • Oven controls improperly set. See the <i>Oven Control, Clock and Timer</i> section. |
| OVEN LIGHT DOES NOT WORK | <ul style="list-style-type: none"> • Light bulb is loose or defective. Tighten or replace the bulb. • Pad operating light is broken. Call for service. |
| OVEN TEMPERATURE TOO HOT OR TOO COLD | <ul style="list-style-type: none"> • Oven thermostat needs adjustment. See the <i>Adjust the Oven Thermostat Do it yourself!</i> section. |
| OVEN WILL NOT WORK | <ul style="list-style-type: none"> • A fuse in your home may be blown or the circuit breaker tripped. Replace the fuse or reset the circuit breaker. • Oven controls improperly set. |
| FOOD DOES NOT BAKE OR ROAST PROPERLY | <ul style="list-style-type: none"> • Oven controls improperly set. See the <i>Baking or Roasting</i> section. • Shelf position is incorrect or the shelf is not level. • Incorrect cookware or cookware of improper size being used. • Oven thermostat needs adjustment. See the <i>Adjust the Oven Thermostat Do it yourself!</i> section. |
| FOOD DOES NOT BROIL PROPERLY | <ul style="list-style-type: none"> • Door not open to the broil stop position as recommended. • Oven controls improperly set. Make sure you press the BROIL HI/LO pad. • Improper shelf position being used. See the <i>Broiling guide</i>. • Food being cooked in a hot pan. Use the broiling pan and grid that came with your oven. Make sure that it is cool. • Cookware not suited for broiling. Use the broiling pan and grid that came with your oven. • The probe is plugged into the outlet in the oven. Remove the probe from the oven. • Aluminum foil used on the broiling pan and grid has not been fitted properly and slit as recommended. • In some areas the power (voltage) may be low. Preheat the broil element for 10 minutes. Broil for the longest period of time recommended in the <i>Broiling guide</i>. |
| OVEN WILL NOT SELF CLEAN | <ul style="list-style-type: none"> • The oven temperature is too high to set a self-clean operation. Allow the oven to cool and reset the controls. • Oven controls improperly set. See the <i>Using the Self-Cleaning Oven</i> section. • The probe is plugged into the outlet in the oven. Remove the probe from the oven. |
| “CRACKING” OR “POPPING” SOUND | <ul style="list-style-type: none"> • This is normal. It is the sound of the metal heating and cooling during both cooking and cleaning functions. |
| EXCESSIVE SMOKING DURING CLEAN CYCLE | <ul style="list-style-type: none"> • Excessive soil. Press the CLEAR/OFF pad. Open the windows to rid the room of smoke. Wait until the LOCKED light goes off. Wipe up the excess soil and reset the clean cycle. |

Before You Call For Service...

Wall Oven

Trouble-shooting tips

| PROBLEM | POSSIBLE CAUSE |
|---|---|
| OVEN DOOR WILL NOT OPEN AFTER A CLEAN CYCLE | <ul style="list-style-type: none"> The oven is too hot. Allow the oven to cool below locking temperature. |
| OVEN NOT CLEAN AFTER A CLEAN CYCLE | <ul style="list-style-type: none"> Oven controls improperly set. See the <i>Using the Self-Cleaning Oven</i> section. Oven was heavily soiled. Clean up heavy spillovers before starting the clean cycle. Heavily soiled ovens may need to self-clean again or for a longer period of time. |
| “LOCK” FLASHES IN THE DISPLAY | <ul style="list-style-type: none"> The self-clean cycle has been selected but the door is not closed. Close the oven door. |
| LOCKED LIGHT IS ON WHEN YOU WANT TO COOK | <ul style="list-style-type: none"> The oven door is locked because the temperature inside the oven has not dropped below the locking temperature. Press the CLEAR/OFF pad. Allow the oven to cool. |
| CONTROL SIGNALS AFTER ENTERING COOKING TIME OR DELAY START | <ul style="list-style-type: none"> You forgot to enter a bake temperature or cleaning time. Press the BAKE pad and desired temperature or the SELF CLEAN pad and desired clean time. |
| “F— AND A NUMBER OR LETTER” FLASH IN THE DISPLAY | <ul style="list-style-type: none"> You have a function error code. Press the CLEAR/OFF pad. Allow the oven to cool for one hour. Put the oven back into operation. Disconnect all power to the oven for 30 seconds and then reconnect power. If the function error code repeats, call for service. |
| DISPLAY GOES BLANK | <ul style="list-style-type: none"> A fuse in your home may be blown or the circuit breaker tripped. Replace the fuse or reset the circuit breaker. The clock is in the black-out mode. See the <i>Oven Control, Clock and Timer</i> section. |
| DISPLAY FLASHES | <ul style="list-style-type: none"> Power failure. Reset the clock. |
| UNABLE TO GET THE DISPLAY TO SHOW “SF” | <ul style="list-style-type: none"> Oven control pads were not pressed properly. The BAKE and the BROIL HI/LO pads must be pressed at the same time and held for 3 seconds. |
| “PROBE” APPEARS IN THE DISPLAY | <ul style="list-style-type: none"> This is reminding you to enter a probe temperature after plugging in the probe. Enter a probe temperature. |
| POWER OUTAGE, CLOCK FLASHES | <ul style="list-style-type: none"> Power outage or surge. Reset the the clock. If the oven was in use, you must reset it by pressing the CLEAR/OFF pad, setting the clock and resetting any cooking function. |
| STEAM FROM THE VENT | <ul style="list-style-type: none"> When using the convection feature, it is normal to see steam coming out of the oven vent. As the number of shelves or amount of food being cooked increases, the amount of visible steam will increase. |
| “BURNING” OR “OILY” ODOR EMITTING FROM THE VENT | <ul style="list-style-type: none"> This is normal in a new oven and will disappear in time. To speed the process, set a self-clean cycle for a minimum of 3 hours. See the <i>Using the Self-Cleaning Oven</i> section. |
| STRONG ODOR | <ul style="list-style-type: none"> This is temporary. An odor from the insulation around the inside of the oven is normal for the first few times the oven is used. |
| FAN NOISE | <ul style="list-style-type: none"> A cooling fan or a convection fan (depending on the function you are using) may automatically turn on and off. This is normal. The cooling fan will turn off and on. The convection fan will run until the function is over or the door is opened. |

**Consumer Product
Ownership Registration**
Important Mail Today

GE Appliances



Place
1st Class
Letter
Stamp
Here

General Electric Company
Warranty Registration Department
P.O. Box 32150
Louisville, KY 40232-2150

Consumer Product Ownership Registration

Dear Customer:

Thank you for purchasing our product and thank you for placing your confidence in us. We are proud to have you as a customer!

Follow these three steps to protect your new appliance investment:

1 Complete and mail your Consumer Product Ownership Registration today. Have the peace of mind of knowing we can contact you in the unlikely event of a safety modification.

2 After completing this registration, write your model and serial numbers in this manual. You will need this information should you require service. The service number in the USA: 800.444.1845. In Canada: 1.888.880.3030.

3 Read your Owner's Manual carefully. It will help you operate your new appliance properly.

Important: To ensure that your product is registered, mail the separate product registration card. If the separate product registration card is missing, fold and mail the form below. No envelope is needed.

FOLD HERE

Consumer Product Ownership Registration



Product
Wall Oven

Model

Serial

Mr. Ms. Mrs. Miss

First Name _____ Last Name _____

Street Address _____

Apt. # _____

City _____ State _____ Zip Code _____

Date Placed In Use Month _____ Day _____ Year _____ Phone Number _____-_____-_____



www.monogram.com



TAPE CLOSED

With the purchase of your new Monogram appliance, receive the assurance that if you ever need information or assistance from GE, we'll be there. All you have to do is call—toll-free!

GE Answer Center®

800.626.2000

Whatever your question about any Monogram major appliance, GE Answer Center® information service is available to help. Your call—and your question—will be answered promptly and courteously. And you can call any time. GE Answer Center® service is open 24 hours a day, 7 days a week.

OR

Visit our Website at: www.monogram.com

In-Home Repair Service

In the U.S.A.:
800.444.1845

In Canada:
888.880.3030

A GE consumer service professional will provide expert repair service, scheduled at a time that's convenient for you. Many GE Consumer Service company-operated locations offer you service today or tomorrow, or at your convenience (7:00 a.m. to 7:00 p.m. weekdays, 9:00 a.m. to 2:00 p.m. Saturdays). Our factory-trained technicians know your appliance inside and out—so most repairs can be handled in just one visit.

For Customers With Special Needs...

800.626.2000

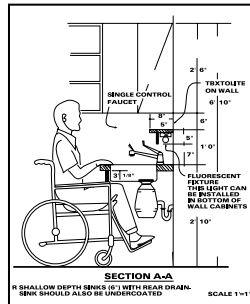

GE offers, free of charge, a brochure to assist in planning a barrier-free kitchen for persons with limited mobility.

Consumers with impaired hearing or speech who have access to a TDD or a conventional teletypewriter may call 800.TDD.GEAC (800.833.4322) to request information or service.

Service Contracts

800.626.2224

You can have the secure feeling that GE Consumer Service will still be there after your warranty expires. Purchase a GE contract while your warranty is still in effect and you'll receive a substantial discount. With a multiple-year contract, you're assured of future service at today's prices.

Parts and Accessories

800.626.2002

Individuals qualified to service their own appliances can have parts or accessories sent directly to their home. The GE parts system provides access to over 47,000 parts...and all GE Genuine Renewal Parts are fully warranted. VISA, MasterCard and Discover cards are accepted.

User maintenance instructions contained in this manual cover procedures intended to be performed by any user. Other servicing generally should be referred to qualified service personnel. Caution must be exercised, since improper servicing may cause unsafe operation.

YOUR MONOGRAM WALL OVEN WARRANTY

Staple sales slip or cancelled check here. Proof of original purchase date is needed to obtain service under warranty.

WHAT IS COVERED

FULL ONE-YEAR WARRANTY

For one year from date of original purchase, we will provide, free of charge, parts and service labor in your home to repair or replace **any part of the oven** that fails because of a manufacturing defect.

.....

This warranty is extended to the original purchaser and any succeeding owner for products purchased for ordinary home use in the 48 mainland states, Hawaii and Washington, D.C. In Alaska the warranty is the same except that it is LIMITED because you must pay to ship the product to the service shop or for the service technician's travel costs to your home.

All warranty service will be provided by our Factory Service Centers or by our authorized Customer Care® servicers during normal working hours.

Should your appliance need service, during warranty period or beyond, in the U.S.A. call 800.444.1845. In Canada: 888.880.3030.

WHAT IS NOT COVERED

- Service trips to your home to teach you how to use the product.
 - Replacement of house fuses or resetting of circuit breakers.
 - Damage to the product caused by accident, fire, floods or acts of God.
 - Failure of the product if it is used for other than its intended purpose or used commercially.
 - Improper installation.
- If you have an installation problem, contact your dealer or installer. You are responsible for providing adequate electrical, gas, exhausting and other connecting facilities as described in the Installation Instructions provided with the product.**
- Incidental or consequential damage caused by possible defects with this appliance.
-

Some states do not allow the exclusion or limitation of incidental or consequential damages, so the above limitation or exclusion may not apply to you. This warranty gives you specific legal rights, and you may also have other rights which vary from state to state.

To know what your legal rights are in your state, consult your local or state consumer affairs office or your state's Attorney General.

Warrantor: General Electric Company. Louisville, KY 40225

| |
|----------------|
| 164D4290P058-1 |
| 49-80100-1 |

08-01 JR

ZET737 ZET757