



Monogram™

## ZISB36DC - GE Monogram 36" Built-In Refrigerator with Dispenser and Water Filter

### Design Information

#### Advanced Planning for a Flush Installation

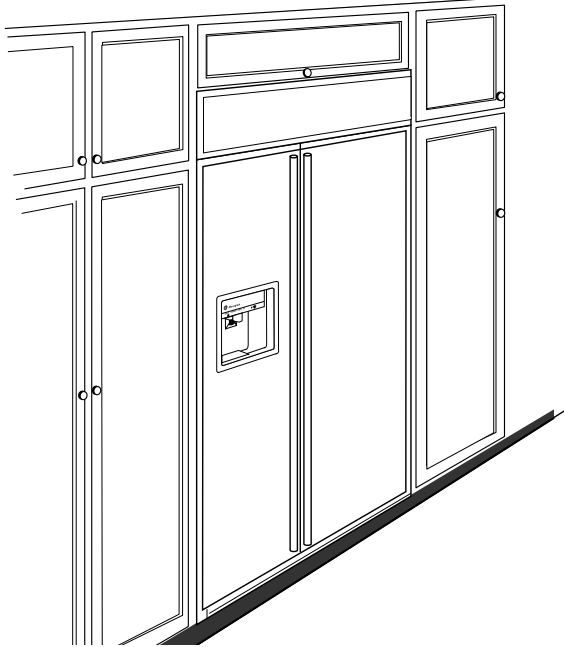

#### Side Panels Requirements:

- Side panels are not required whenever the refrigerator is installed into an enclosure or between pantry and oven cabinets.
- Side panels are required whenever the sides of the refrigerator are exposed.
- Side panel sizes vary depending on type of installation being made.

#### For a flush installation, you must:

1. Determine the need for side panels.
2. Determine side panel thickness.
3. Order matching side panels from the cabinet manufacturer. Be sure to provide the exact dimensions.

The following cutout dimensions examples will provide a flush fit. If you have a unique installation situation (other than those illustrated here), see Product Dimensions to calculate the rough-in dimensions.

Monogram built-in refrigerators are designed to be installed with typical 24-3/4" deep cabinetry.

In a flush installation, the refrigerator doors will align evenly with the front face of adjacent cabinets.

### Installation Between Wall Oven and Pantry Cabinet

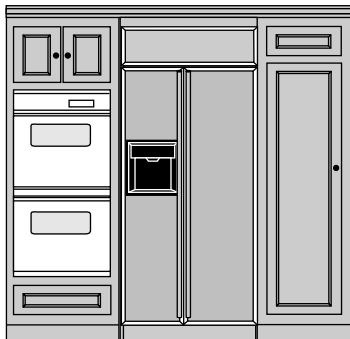

Side panels are not required whenever the refrigerator is installed into an enclosure or between pantry and oven cabinets.

**The minimum cutout for a custom enclosure should be:**

84" Hx36" Wx24-3/4" D

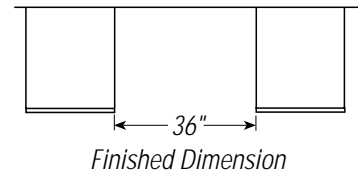

For answers to your Monogram®, GE Profile Performance Series™, GE Profile™ or GE appliance questions, call GE Answer Center® service, 800.626.2000.





Monogram™

## ZISB36DC - GE Monogram 36" Built-In Refrigerator with Dispenser and Water Filter

### Design Information

#### Installation Between Base & Wall Cabinets

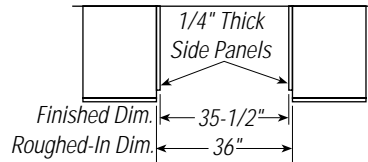
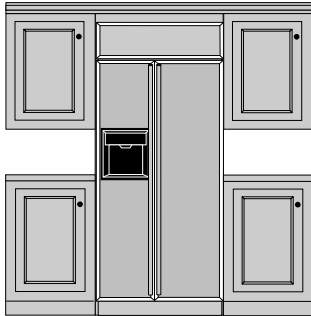

Note: 1/4" thick side panels can be inserted into the case trim, making the rough-in the same as the outside trim width, 36".

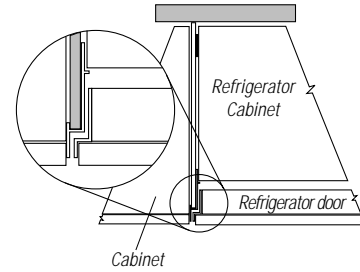

1/4" Side Panels. Insert end of side panel into trim.

#### Installation at End of Run

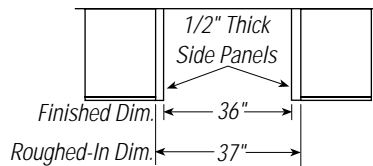
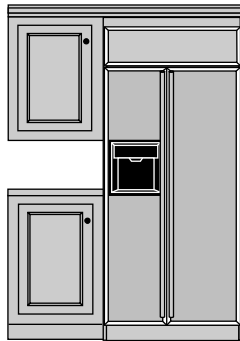

Note: 1/2" thick side panels shown. Side panels can be any thickness. Add side panel thickness to outside trim width (36") to calculate the rough-in dimension

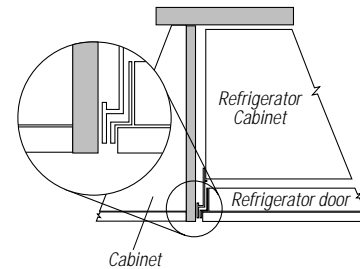

1/2" To 3/4" Side Panels. Leading Edge Flush With Cabinet.

#### Frameless Cabinets

Side panels, 1/2" minimum thickness are required when using frameless cabinets. The side panel acts as a spacer between the cabinet and the case trim and prevents interference with cabinet door swing.

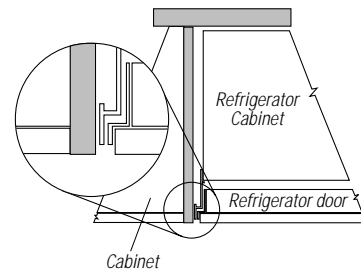
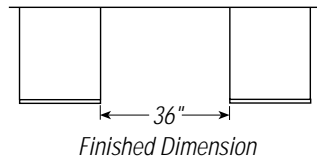

1/2" To 3/4" Side Panels. Leading Edge Flush With Cabinet.

For answers to your Monogram®, GE Profile Performance Series™, GE Profile™ or GE appliance questions, call GE Answer Center® service, 800.626.2000.



Listed by Underwriters Laboratories



Monogram™

# ZISB36DC - GE Monogram 36" Built-In Refrigerator with Dispenser and Water Filter

## True Flush Installation

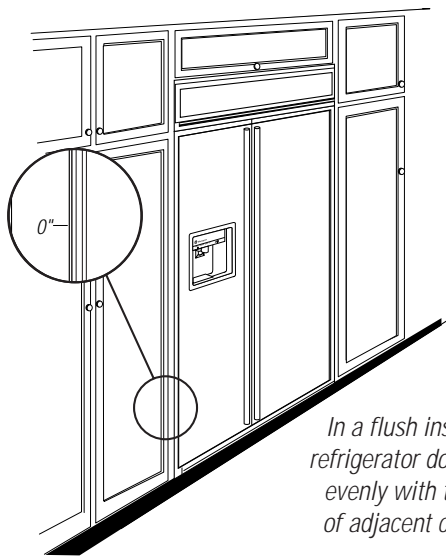

In a flush installation, the refrigerator doors will align evenly with the front-face of adjacent cabinet doors.

### Advantage

- The flush appearance allows the refrigerator to blend into the surrounding cabinetry or wall.
- The flush fit uses less floor space.
- A custom continuous toe-kick may be used to form an unbroken line at the base of cabinetry.

### Disadvantage

- The enclosure must be constructed accurately and perfectly square, otherwise, gaps between case trim and surrounding cabinetry will show.

## Semi-Flush Installation

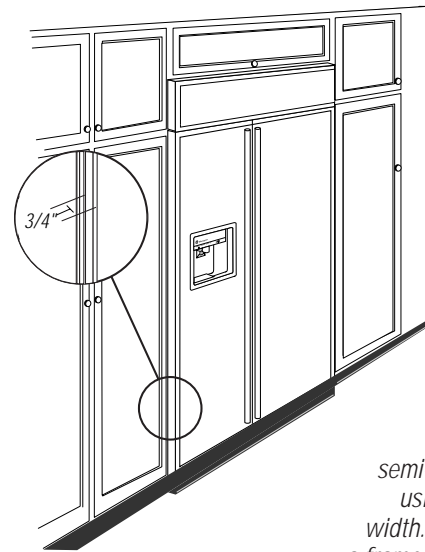

These refrigerators can also be installed semi-flush into an enclosure using the minimum cutout width. The case trim provides a frame around the refrigerator.

### Advantage

- If cabinetry or enclosure is not perfectly square, the case trim will cover the surrounding cabinetry edges.

### Disadvantage

- The refrigerator will project forward, approximately 3/4" beyond the front face of surrounding cabinetry. The top grille panel will project forward of upper cabinetry or soffit.

36" Models 12-3/8"  
42" Models 18-3/8"  
48" Models 20-3/8"

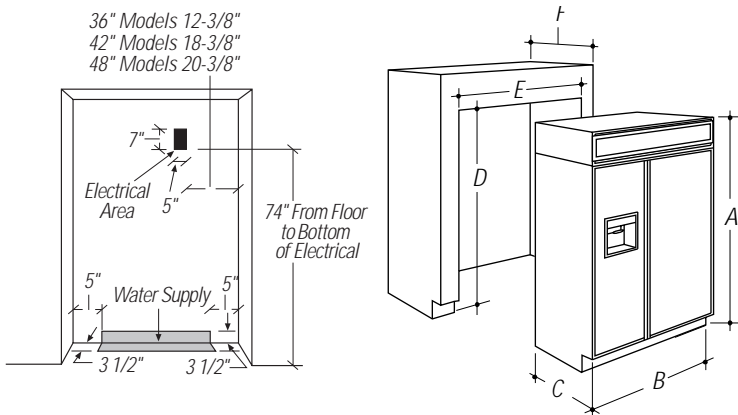

		ZISW48D ZISB48D ZIS48N	ZISW42D ZISB42D ZIS42N	ZISW36D ZISB36D ZIS36N
<b>PRODUCT DIMENSIONS</b>	<b>A*</b>	83"	83"	83"
	<b>B</b>	48"	42"	36"
	<b>C</b>	24-3/4"	24-3/4"	24-3/4"
<b>FINISHED FLUSH ENCLOSURE</b>	<b>D*</b>	84"	84"	84"
	<b>E†</b>	48" Min.	42" Min.	36" Min.
	<b>F</b>	24-3/4" Min.	24-3/4" Min.	24-3/4" Min.
<b>FINISHED SEMI-FLUSH ENCLOSURE</b>	<b>D*</b>	84"	84"	84"
	<b>E†</b>	47-1/2" Min.	41-1/2" Min.	35-1/2" Min.
	<b>F</b>	24" Min.	24" Min.	24" Min.

\*Factory set installation height is 84". Height adjustments are accomplished with optional grille panel frame kits. Order ZG2 grille panel kit for all ZIS models.

† Side panels are not required when installing into an enclosure. Side panels are required whenever the sides of the refrigerator are exposed. If side panels are used, add side panel thickness to calculate finished cutout width.

See Installation Instructions for Details, Order Pub. No. 49-6964-2 for ZIS36 models, Pub. No. 49-6963-2 for ZIS42 models and Pub. No. 49-6962-2 for ZIS48 models.

Specification Created 12/99

For answers to your Monogram® GE Profile Performance Series™ GE Profile™ or GE appliance questions, call GE Answer Center® service, 800.626.2000.





Monogram™

## ZISB36DC - GE Monogram 36" Built-In Refrigerator with Dispenser and Water Filter

### Dimensions and Specifications (in inches)

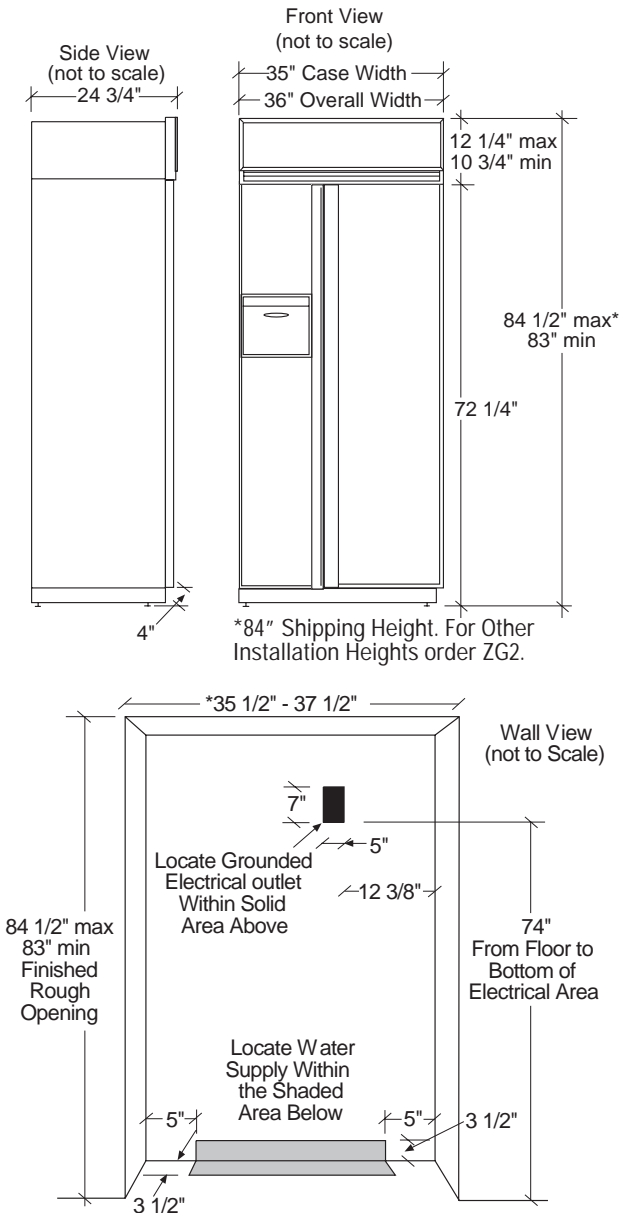

\*The finished and rough-in dimensions are determined by the type of installation being made. The rough-in cutout width includes side panel thicknesses. See "Advanced Planning For A Flush Installation."

**Design Information:** Designed to be installed flush with surrounding cabinetry. Cutout dimensions, clearances and side panel sizes are determined by the many installation options available. Side panels must be used whenever the sides of the refrigerator will be exposed. Side panels are not required when refrigerator is installed into an enclosure or between pantry and oven cabinets. **Important**-Side panels, 1/2" min. thickness are required for **frameless cabinets**.

Field installed custom panels, Lexan® or stainless steel panels are required. Custom door panels and grille panel sizes vary to accommodate the kit being used.

A custom toekick can be installed to match or complement the surrounding cabinetry. A standard toekick is supplied. For a custom toekick, use supplied toekick as a template to cut notches for hinges and water lines.

#### Optional Kits:

- ZWBP36: Black Lexan® Panel Kit (no trim kit required).
- ZWWP36: White Lexan® Panel Kit (no trim kit required).
- ZWSP36: Stainless Steel Panel Kit (no trim kit required).
- ZKH1: Provides for the installation of a custom handle on 1/4" custom panels.
- ZG2: Provides 1/4" grille panel frame side pieces for 83", 83-1/2" and 84-1/2" installation heights. Factory set height is 84".
- ZKT36: Provides for the installation of 3/4" custom door and grille panels.
- ZKHT1: Provides for the installation of a custom handle using 3/4" custom panels. (This kit must be used in combination with ZKT36.)
- ZKHSS1: Tubular stainless steel handles on 1/4" panels.
- ZKHTSS1: Tubular stainless steel handles on 3/4" panels. This kit must be used in combination with ZKT48.
- ZWCD1: Provides for the installation of a custom collar trim on the dispenser for one continuous custom panel on the freezer door. This kit can be used alone, or with one or more kits.

**Additional Specifications:** A 115 volt 60 Hz., 15 or 20 amp power supply is required. An individual properly grounded branch circuit or circuit breaker is recommended. Install a properly grounded 3-prong electrical receptacle recessed into the back wall. Electrical must be located on rear wall.

Water line can enter opening through the floor or back wall. The water line should be 1/4" O.D. copper tubing between the cold water line and water connection location, long enough to extend to the front of the refrigerator. Installation of an easily accessible shut off valve in the water line is recommended.

**Clearances:** If the refrigerator is to be installed in a corner, a 4" min. clearance between the case trim and adjacent wall on both sides of the refrigerator will assure a 90° door opening and access to all drawers. A 10" clearance is required on both sides for removal of pans.

For answers to your Monogram®,

GE Profile Performance Series™

GE Profile™ or GE appliance questions, call

GE Answer Center® service, 800.626.2000.





Monogram™

## ZISB36DC - GE Monogram 36" Built-In Refrigerator with Dispenser and Water Filter

### Dimensions and Specifications (in inches)

**Custom Door Panel Dimensions When Using Trim Kit**  
ZKT36, 3/4" thick panel with standard handle and/or ZWCD1 custom collar trim (*not to scale*)

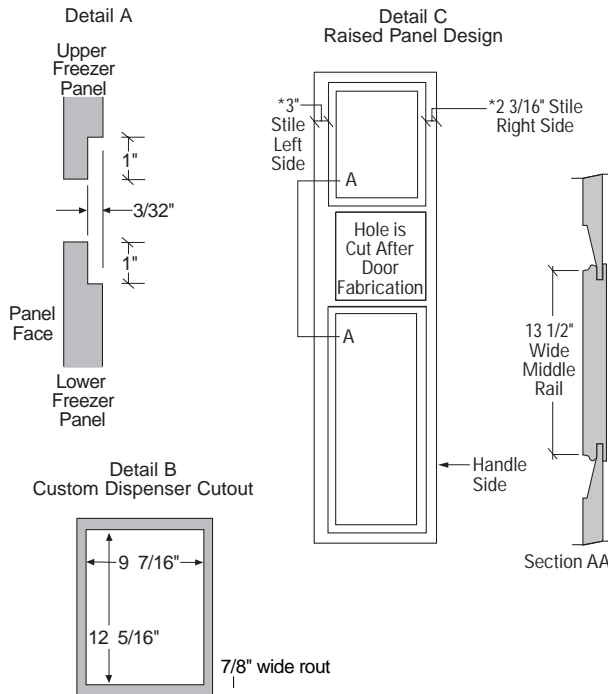
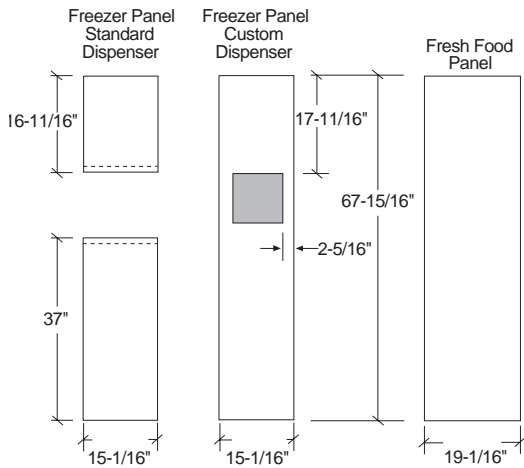

The Cutout is 9 7/16" wide by 12 5/16" high. 3/4" panels must be routed on all four sides of the cutout. Rout the back side of the panel 1/4" deep 7/8" wide. (shaded area)

The ZKT36 trim kit provides for the installation of 3/4" custom door and grille panels, using the standard full-length handle. Cut panels to size and install.

For standard dispenser trim: Cut panels to size, rout the bottom of the upper freezer panel and the top of the lower freezer panel to allow placement of support brackets and install (see detail A).

For custom dispenser trim ZWCD1 kit must be used: Cut panels to size, refer to detail B for dispenser cutout routing instructions and install. When a raised panel design is used, custom width stiles and custom middle rail is required. A 13-1/2" wide middle rail must be used because the custom collar trim must be located within the raised portion of the panel. This area must be 3/4" thick. See Detail C for raised panel.

### Custom Grille Panel

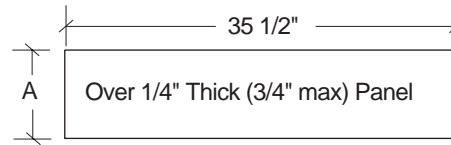

Grille Panel height can vary to fill installation height.

Installation Height	Dimension A
83"	8-1/4"
83-1/2"	8-3/4"
84"	9-1/4"
84-1/2"	9-3/4"

**Important:** Maintain 1-1/2" minimum gap between top of doors and bottom of grille panel.

For answers to your Monogram®, GE Profile Performance Series™, GE Profile™ or GE appliance questions, call GE Answer Center® service, 800.626.2000.





Monogram™

# ZISB36DC - GE Monogram 36" Built-In Refrigerator with Dispenser and Water Filter

## Dimensions and Specifications (in inches)

### Custom Door Panel Dimensions Using Standard Trim 1/4" thick panels or Panels secured to 1/4" thick backing

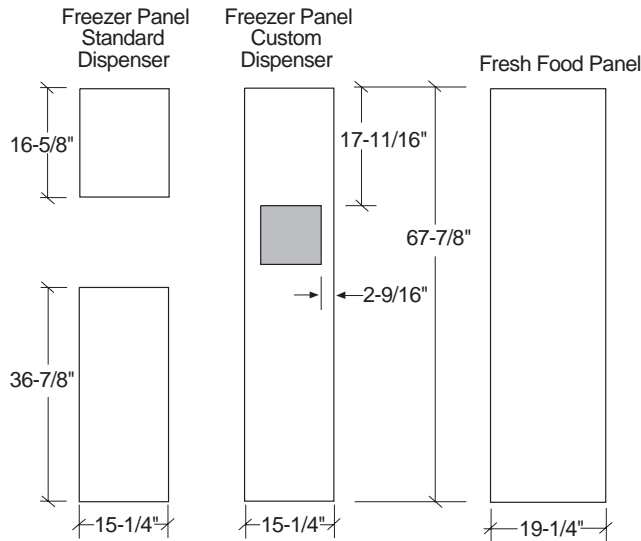

**Standard Trim with 1/4" Panels:** 1/4" Panels: Cut panels to size.

Custom handles with 1/4" door panels require Trim Kit ZKH1. When using ZKH1 with the standard dispenser trim, the length of the custom handle, top to bottom cannot exceed 11-3/4".

Tubular stainless steel handle kit ZKHSS1.

Custom collar dispenser trim with 1/4" door panels require trim kit ZWCD1.

**Standard Trim with Panels secured to 1/4" thick backing:** Applying a raised panel design to a 1/4" thick backing (screwed or glued): Cut 1/4" panels to size, fabricate the raised panel to permit clearances of at least 2" from the handle side for fingertip clearance, 1-1/4" from the hinge side to avoid striking adjacent cabinetry and 5/16" from the top and bottom edges to allow for the trim flange, then install.

Countertops adjacent to refrigerator installation should be mitered 45° degrees.

**Note:** ZWCD1 custom collar dispenser trim and ZKHT1 custom handle kits cannot be used in this configuration.

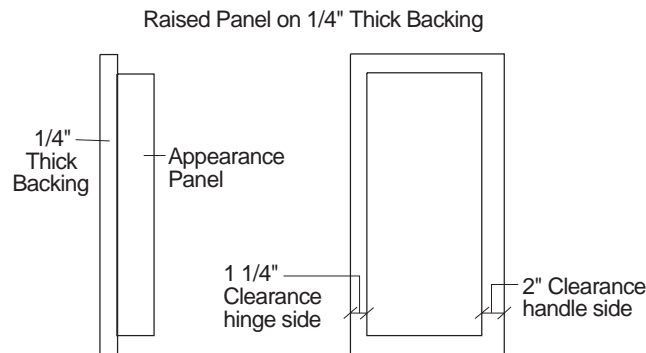

### Custom Grille Panel

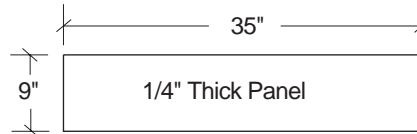

Panel frame is factory assembled for 84" installation height. If installation height varies, order ZG2 trim kit which provides optional side trim panels. Cut Lexan® or stainless panels to sizes shown below.

### Custom Dispenser Cutout

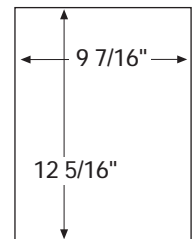

The Cutout is 9 7/16" wide by 12 5/16" high.

Installation Height	Dimension A
83"	8"
83-1/2"	8-1/2"
84-1/2"	9-1/2"

**Important:** Maintain 1-1/2" min. gap between top of doors and bottom of panel frame.

For answers to your Monogram®, GE Profile Performance Series™, GE Profile™ or GE appliance questions, call GE Answer Center® service, 800.626.2000.

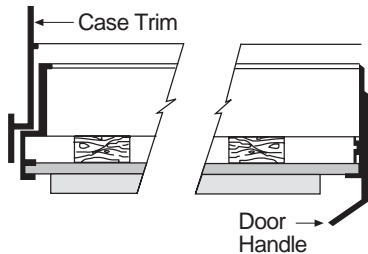



Monogram™

## ZISB36DC - GE Monogram 36" Built-In Refrigerator with Dispenser and Water Filter

### Dimensions and Specifications (in inches)

**Custom Door Panel Dimensions When Using Trim Kit ZKT36 3/4" thick panel with custom handle and/or ZWCD1 custom collar trim.**

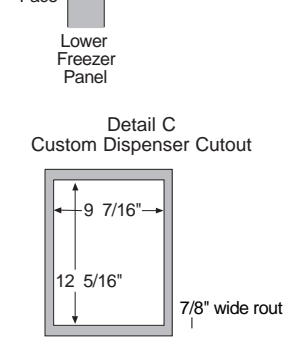
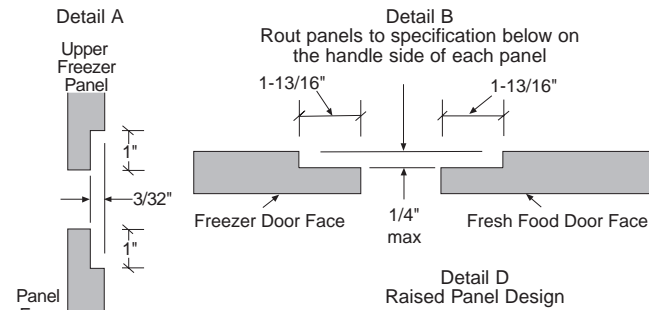
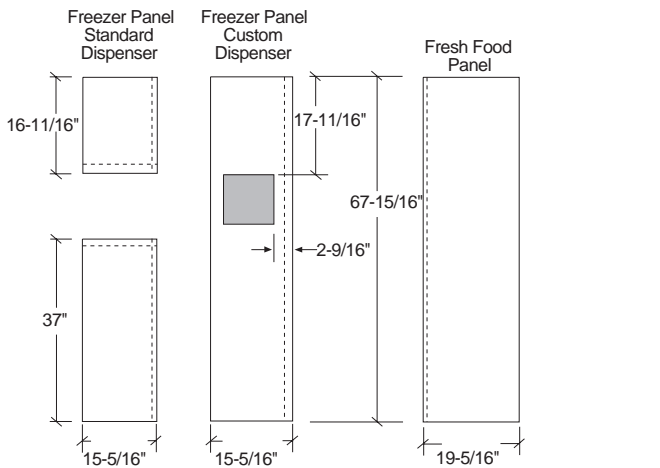

The Cutout is 9 7/16" wide by 12 5/16" high. 3/4" panels must be routed on all four sides of the cutout. Rout the back side of the panel 1/4" deep 7/8" wide. (shaded area)

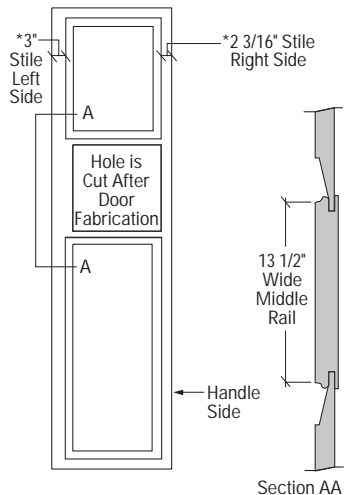

ZKT36 and ZKHT1 installed together provides for the installation of 3/4" custom door and grille panels, using a custom handle of your choice. Cut panels to size, rout the handle side of the panels as shown below and install (see detail B). For ZKHTSS1, tubular stainless steel handle kit, cut panels to size and rout the handle side of the panels as shown in detail B.

For standard dispenser trim: Cut panels to size, rout the handle side of the panels as shown in detail B, rout the bottom of the upper freezer panel and the top of the lower freezer panel to allow placement of support brackets (see detail A) and install.

For custom dispenser trim ZWCD1 kit must be used: Cut panels to size, refer to detail C for dispenser cutout routing instructions and install. When a raised panel design is used, custom width stiles and custom middle rail is required. A 13-1/2" wide middle rail must be used because the custom collar trim must be located within the raised portion of the panel. This area must be 3/4" thick. See Detail D for raised panel.

When using the standard full-width dispenser trim, the length of the custom handle, top to bottom cannot exceed 11-3/4". Locate the handle a minimum of 3/4" and a maximum of 1-1/2" from the edge of the panel. There are no length restrictions on handles for models using a custom collar dispenser trim (ZWCD1).

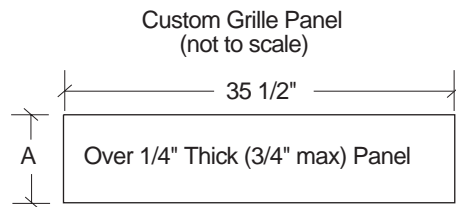

Grille Panel height can vary to fill installation height.

Installation Height	Dimension A
83"	8-1/4"
83-1/2"	8-3/4"
84"	9-1/4"
84-1/2"	9-3/4"

**Important:** Maintain 1-1/2" minimum gap between top of doors and bottom of grille panel.

For answers to your Monogram®, GE Profile Performance Series™, GE Profile™ or GE appliance questions, call GE Answer Center® service, 800.626.2000.





Monogram™

# ZISB36DC - GE Monogram 36" Built-In Refrigerator with Dispenser and Water Filter

## Dimensions and Specifications (in inches)

Side panels must be used whenever the sides of the refrigerator will be exposed.

**1/4" Side Panels**  
Insert end of side panel into trim.

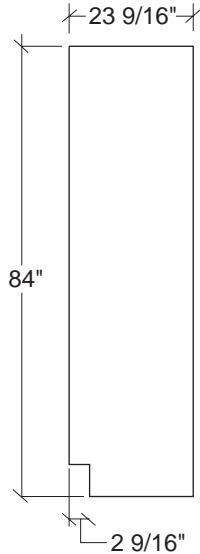
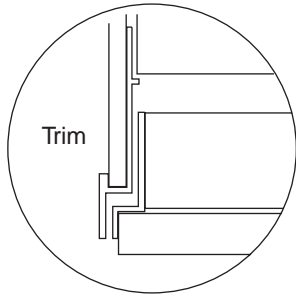

Standard 4" high toe-kick or trim to fit.  
Height may vary depending on application.

**1/2" to 3/4" Side Panels**  
Recessed front edge.

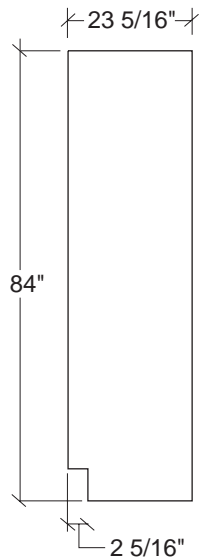
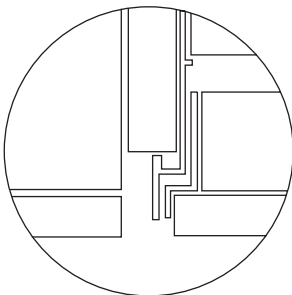

Standard 4" high toe-kick or trim to fit.  
Height may vary depending on application.

\*Not to scale.

**1/2" to 3/4" Side Panels**  
Leading Edge  
Flush with Cabinet  
Front.

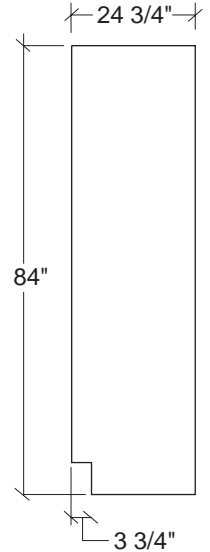
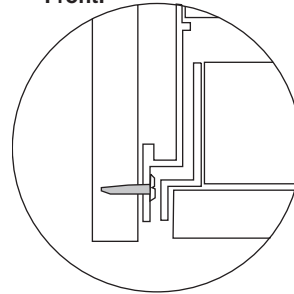

Standard 4" high toe-kick or trim to fit.  
Height may vary depending on application.

**1/2" to 3/4" Side Panels**  
Leading edge routed  
1/4" deep, 1-1/2" top to  
bottom.

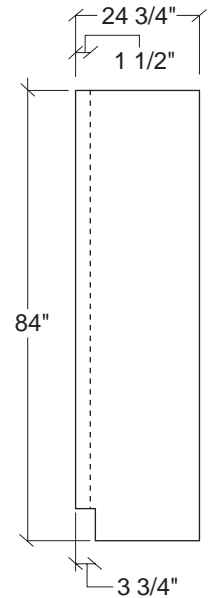
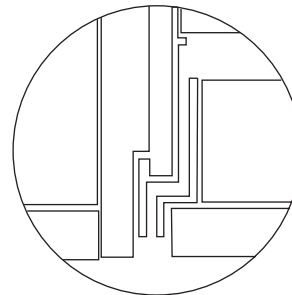

Standard 4" high toe-kick or trim to fit.  
Height may vary depending on application.

For answers to your Monogram®,  
GE Profile Performance Series™,  
GE Profile™ or GE appliance questions, call  
GE Answer Center® service, 800.626.2000.



Listed by  
Underwriters  
Laboratories





*Monogram™*

## **ZISB36DC - GE Monogram 36" Built-In Refrigerator with Dispenser and Water Filter**

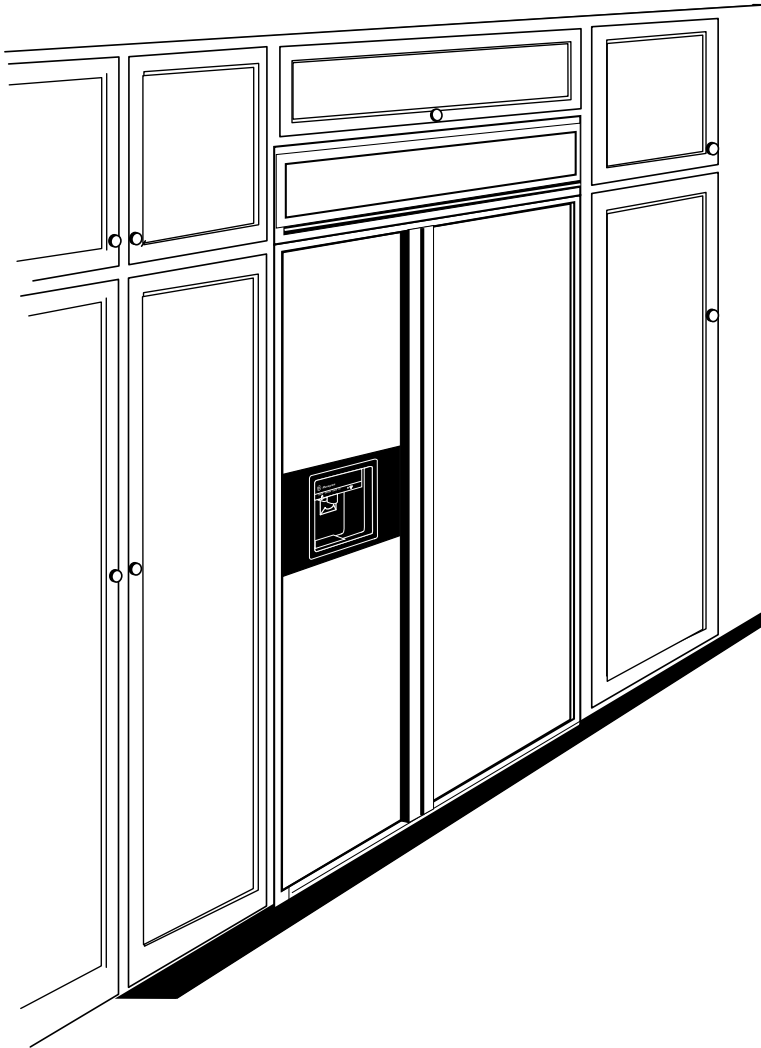

### **Features and Benefits**

- 21.2 cu. ft. Capacity (Fresh Food 12.0 cu. ft., Freezer 9.2 cu. ft.)
- GE SmartWater™ Filtration System
- Exterior Dispenser with Cubes, Crushed Ice and Chilled Water
- 2 Adjustable Humidity Vegetable/Fruit Pans
- Sealed Snack Pan
- 4 Adjustable Spill-Proof Glass Fresh Food Shelves
- Slide-Back Shelf
- 5 Adjustable Fresh Food Door Bins
- Dairy Compartment
- Wine Holder
- Glass-Covered Butter Dish
- 4 Adjustable Wire Freezer Shelves
- 2 Utility Baskets
- 3 Adjustable Freezer Door Bins
- Full-Length Aluminum Door Handles
- Model ZISW36DC—White Dispenser
- Model ZISB36DC—Black Dispenser