



# Top-Freezer Refrigerators

**Safety Information**

- Adapter Plugs .....4
- Connect Electricity .....4
- Extension Cords .....3
- Proper Disposal .....3
- Safety Precautions .....2

**Operating Instructions**

- Additional Features .....8
- Automatic Icemaker .....9
- Controls .....5
- Shelves and Bins .....6, 7
- Crispers and Pans .....8, 9

**Care and Cleaning**

- Care and Cleaning .....10, 11
- Replacing the Lightbulbs .....12

**Installation Instructions**

- Preparing to Install  
the Refrigerator .....13
- Reversing the Door Swing .....18-23
- Water Line Installation .....14-17

**Troubleshooting Tips**

- Before You Call For Service ... .25, 26
- Normal Operating Sounds .....24

**Consumer Support**

- Consumer Support .....Back Cover
- Product Registration .....27, 28
- Warranty for Canadian Customers . .29
- Warranty for U.S. Customers .....30

**Owner's Manual &  
Installation Instructions**

Models 22, 25

**Write the model and serial numbers here:**

**Model #** \_\_\_\_\_

**Serial #** \_\_\_\_\_

Find these numbers on the gray label on the left side, near the top of the refrigerator compartment.

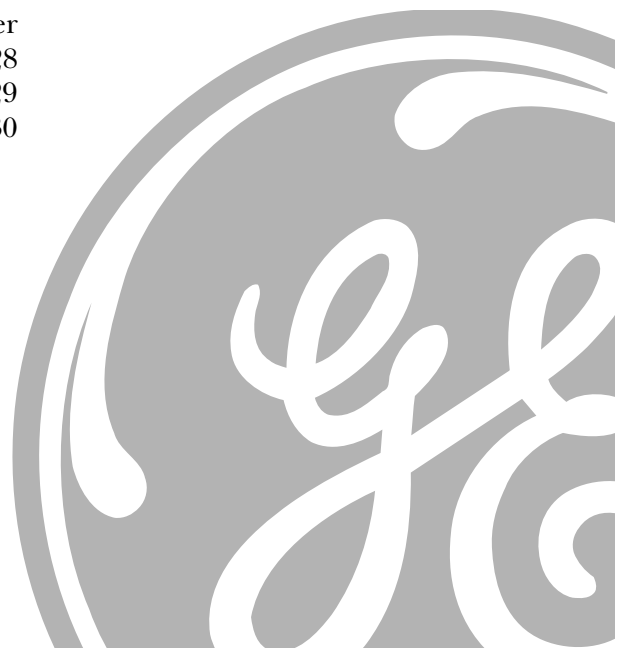

# IMPORTANT SAFETY INFORMATION. READ ALL INSTRUCTIONS BEFORE USING.

## **⚠ WARNING!**

Use this appliance only for its intended purpose as described in this Owner's Manual.



## SAFETY PRECAUTIONS

When using electrical appliances, basic safety precautions should be followed, including the following:

- This refrigerator must be properly installed and located in accordance with the Installation Instructions before it is used.
- Do not allow children to climb, stand or hang on the shelves in the refrigerator. They could damage the refrigerator and seriously injure themselves.
- Do not touch the cold surfaces in the freezer compartment when hands are damp or wet. Skin may stick to these extremely cold surfaces.
- Do not store or use gasoline or other flammable vapors and liquids in the vicinity of this or any other appliance.
- In refrigerators with automatic icemakers, avoid contact with the moving parts of the ejector mechanism, or with the heating element located on the bottom of the icemaker. Do not place fingers or hands on the automatic icemaking mechanism while the refrigerator is plugged in.
- Keep fingers out of the “pinch point” areas; clearances between the doors and between the doors and cabinet are necessarily small. Be careful closing doors when children are in the area.
- Unplug the refrigerator before cleaning and making repairs.  
**NOTE:** We strongly recommend that any servicing be performed by a qualified individual.
- Setting either or both controls to the **O (off)** position does not remove power to the light circuit.
- Do not refreeze frozen foods which have thawed completely.

## **⚠ DANGER! RISK OF CHILD ENTRAPMENT**

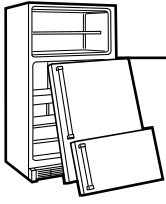

### *PROPER DISPOSAL OF THE REFRIGERATOR*

Child entrapment and suffocation are not problems of the past. Junked or abandoned refrigerators are still dangerous...even if they will sit for "just a few days." If you are getting rid of your old refrigerator, please follow the instructions below to help prevent accidents.

#### **Before You Throw Away Your Old Refrigerator or Freezer:**

- Take off the doors.
- Leave the shelves in place so that children may not easily climb inside.

#### **CFC Disposal**

Your old refrigerator may have a cooling system that used CFCs (chlorofluorocarbons). CFCs are believed to harm stratospheric ozone.

If you are throwing away your old refrigerator, make sure the CFC refrigerant is removed for proper disposal by a qualified servicer. If you intentionally release this CFC refrigerant you can be subject to fines and imprisonment under provisions of environmental legislation.



### *USE OF EXTENSION CORDS*

*Because of potential safety hazards under certain conditions, we strongly recommend against the use of an extension cord.*

However, if you must use an extension cord, it is absolutely necessary that it be a UL-listed (in the United States) or a CSA-listed (in Canada), 3-wire grounding type appliance extension cord having a grounding type plug and outlet and that the electrical rating of the cord be 15 amperes (minimum) and 120 volts.

# IMPORTANT SAFETY INFORMATION. READ ALL INSTRUCTIONS BEFORE USING.

Safety Instructions

## ⚠ WARNING!



### HOW TO CONNECT ELECTRICITY

*Do not, under any circumstances, cut or remove the third (ground) prong from the power cord. For personal safety, this appliance must be properly grounded.*

The power cord of this appliance is equipped with a 3-prong (grounding) plug which mates with a standard 3-prong (grounding) wall outlet to minimize the possibility of electric shock hazard from this appliance.

Have the wall outlet and circuit checked by a qualified electrician to make sure the outlet is properly grounded.

If the outlet is a standard 2-prong outlet, it is your personal responsibility and obligation to have it replaced with a properly grounded 3-prong wall outlet.

The refrigerator should always be plugged into its own individual electrical outlet which has a voltage rating that matches the rating plate.

This provides the best performance and also prevents overloading house wiring circuits which could cause a fire hazard from overheated wires.

Never unplug your refrigerator by pulling on the power cord. Always grip plug firmly and pull straight out from the outlet.

Repair or replace immediately all power cords that have become frayed or otherwise damaged. Do not use a cord that shows cracks or abrasion damage along its length or at either end.

When moving the refrigerator away from the wall, be careful not to roll over or damage the power cord.

Operating Instructions

Installation Instructions



### USE OF ADAPTER PLUGS *(Adapter plugs not permitted in Canada)*

*Because of potential safety hazards under certain conditions, we strongly recommend against the use of an adapter plug.*

However, if you must use an adapter, where local codes permit, a **temporary connection** may be made to a properly grounded 2-prong wall outlet by use of a UL-listed adapter available at most local hardware stores.

The larger slot in the adapter must be aligned with the larger slot in the wall outlet to provide proper polarity in the connection of the power cord.

When disconnecting the power cord from the adapter, always hold the adapter in place with one hand while pulling the power cord plug with the other hand. If this is not done, the adapter ground terminal is very likely to break with repeated use.

If the adapter ground terminal breaks, **DO NOT USE** the refrigerator until a proper ground has been established.

*Attaching the adapter ground terminal to a wall outlet cover screw does not ground the appliance unless the cover screw is metal, and not insulated, and the wall outlet is grounded through the house wiring. You should have the circuit checked by a qualified electrician to make sure the outlet is properly grounded.*

Troubleshooting Tips

Consumer Support



*READ AND FOLLOW THIS SAFETY INFORMATION CAREFULLY.*

**SAVE THESE INSTRUCTIONS**

# About the controls on the refrigerator.

The controls will look like one of the following:

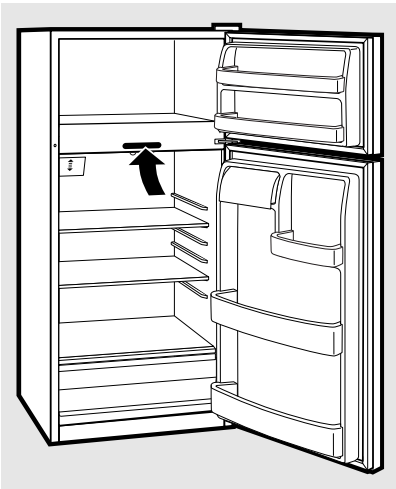
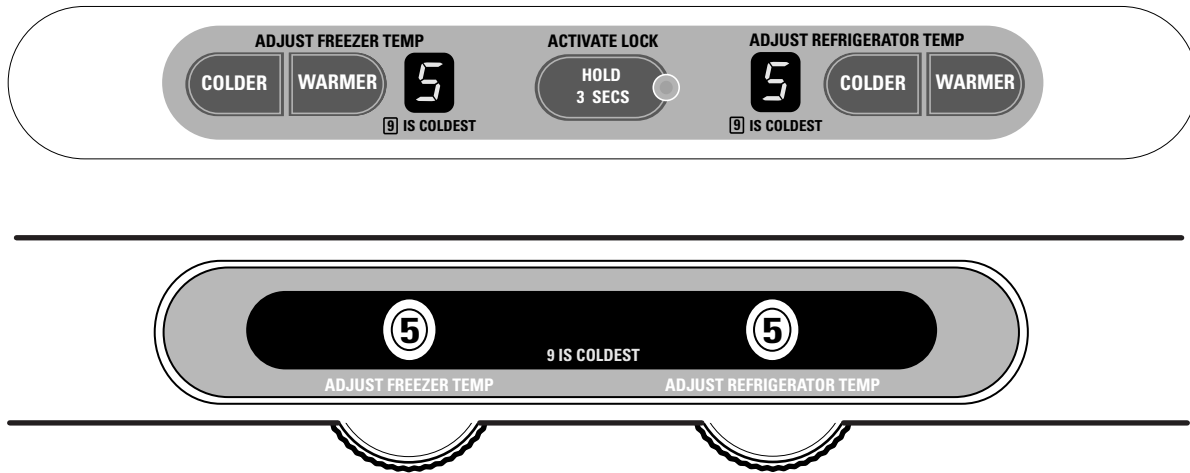

Initially, set the refrigerator control at **5** and the freezer control at **5** and allow 12 hours for the temperature to stabilize.

Several adjustments may be required. Adjust the controls one increment at a time, and allow 12 hours after each adjustment for the refrigerator to reach the temperature you have set.

Setting either or both controls to **0** stops cooling in both the refrigerator and freezer compartments but does not shut off electrical power to the refrigerator.

### Touch pad controls

- Setting either control at **0** will automatically set the other control at **0**. The zeros will blink until you set the controls.
- If both controls are set at **0** and either **COLDER** pad is pressed, the controls will automatically reset to **5**.

**Control settings will vary based on personal preferences, usage and operating conditions and may require more than one adjustment.**

### Locking the Controls (on some models)

This feature allows you to lock the controls so the settings cannot be changed.

#### To lock the controls:

- 1 Set the controls to the desired settings.
- 2 Press and hold the lock pad for 3 seconds.

When the controls are locked, the indicator light will come on and the control settings will not be displayed.

#### To unlock the controls:

Press and hold the lock pad for 3 seconds.

After unlocking the controls, the settings will be displayed, the lock indicator light will go out, and the settings can be changed.

## About the shelves and bins.

Not all features are on all models.

### Rearranging the Shelves

Shelves in the refrigerator and freezer compartments are adjustable.

#### Refrigerator Compartment

##### To remove:

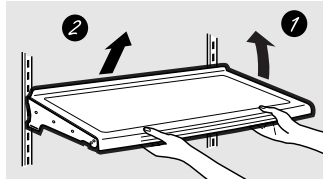

- 1 Tilt the shelf up at the front.
- 2 Lift the shelf up at the back and bring the shelf out.

Some models have wire shelves that can be adjusted in the same manner.

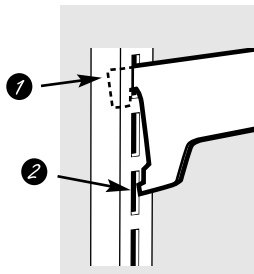

##### To replace:

- 1 While tilting the shelf up, insert the top hook at the back of the shelf in a slot on the track.
- 2 Lower the front of the shelf until the bottom of the shelf locks into place.

#### Freezer Compartment

##### To remove:

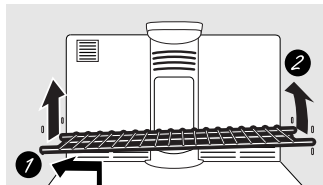

- 1 Lift up the left side of the shelf and slide it left into the center of the shelf supports.
- 2 Rotate the right side of the shelf up and out of the shelf supports.

##### To replace:

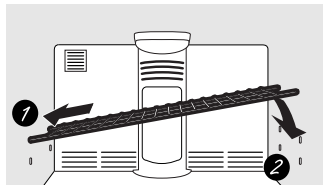

- 1 Holding the shelf diagonally, insert the left end of the shelf into the center of the shelf supports on the side wall at the desired level.
- 2 Insert the right end of the shelf into the shelf supports at the same level. Rest each end of the shelf on the bottom of the shelf supports.

**NOTE:** For models with an automatic icemaker, the freezer shelf must be in the lower position for the ice cube bucket to catch the cubes.

#### Spillproof Shelves (on some models)

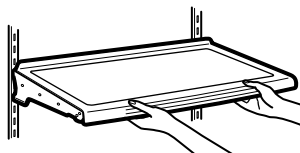

Spillproof shelves have special edges to help prevent spills from dripping to lower shelves. To remove or replace the shelves, see *Rearranging the Shelves*.

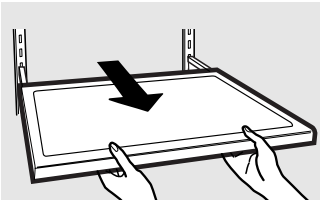

### Slide-Out Spillproof Shelf (on some models)

The slide-out spillproof shelf allows you to reach items stored behind others. The special edges are designed to help prevent spills from dripping to lower shelves.

#### To remove:

- 1 Remove all items from shelf.
- 2 Slide the shelf out until it stops.
- 3 Lift the front edge of the shelf until the central tabs are above the front bar.
- 4 Continue pulling the shelf forward until it can be removed.

#### To replace:

- 1 Place the rear shelf tabs just in front of the central notches on the shelf frame.
- 2 Slide the shelf in until the central tabs are slightly behind the front bar.
- 3 Lower the shelf into place until it is horizontal and slide the shelf in.

*Make sure that the shelf sits flat after reinstallation and doesn't move freely from side to side.*

*Make sure you push the shelves all the way in before you close the door.*

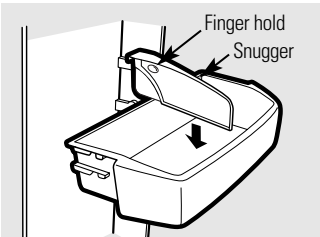

### Adjustable Bins on the Door

Adjustable bins can easily be carried from refrigerator to work area.

**To remove:** Lift bin straight up, then pull out.

**To replace or relocate:** Engage the bin in the molded supports of the door, and push in. Bin will lock in place.

**The snugger** helps prevent tipping, spilling or sliding of small items stored on the door shelf. Grip the finger hold near the rear of the snugger and move it to fit your needs.

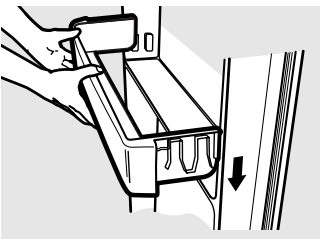

### Non-Adjustable Shelves on the Door

**To remove:** Lift the shelf straight up then pull out.

**To replace:** Engage the shelf in the molded supports on the door and push down. It will lock in place.

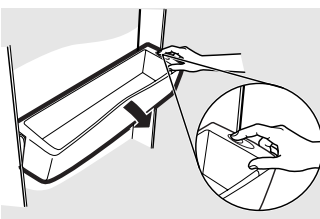

### Freezer Tilt Out Bin (on some models)

Push the button as you tilt out the bin.

**To remove:** Hold the sides of the bin and lift it straight up, then pull out.

**To replace:** Engage the ends of the bin in the molded supports on the door and push down. It will lock in place.

**NOTE: Do not overload the bin.**

## About the additional features.

Not all features are on all models.

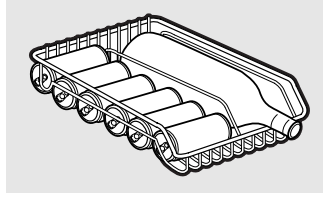

### Shelf Saver Rack (on some models)

Slide-out beverage rack holds twelve cans of soda or two wine/water bottles (lengthwise). It can be removed for cleaning.

**To remove**, slide the rack out to the **stop** position, lift the rack up and past the **stop** position and lift it out.

## About the crispers and pans.

Not all features are on all models.

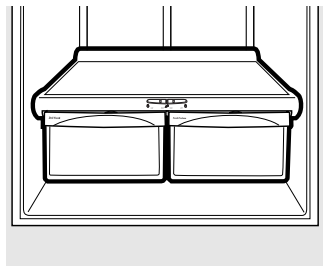

### Fruit and Vegetable Crisper

Excess water that may accumulate in the bottom of the drawers or under the drawers should be wiped dry.

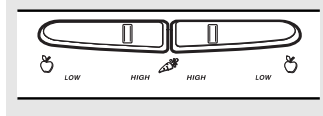

### Adjustable Humidity Crisper (on some models)

Slide the control all the way to the **HIGH** setting to provide high humidity recommended for most vegetables.

Slide the control all the way to the **LOW** setting to provide lower humidity levels recommended for most fruits.

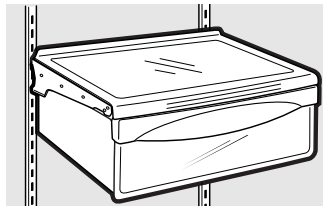

### Snack Pan (on some models)

This pan can be moved to the most useful location for your family's needs.

**To remove**, slide the pan out to the **stop** position, lift the pan up and past the **stop** position and lift it out.

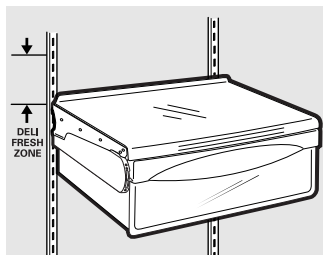

### Adjustable Temperature Deli Pan (on some models)

When the pan is placed in the top 6 slots on the left side and the lever is set at **COLDEST**, air from the freezer is forced around the pan to keep it very cold.

You can move the pan to any location if you don't want the extra cold storage.

The settings can be adjusted anywhere between cold ❄️ and coldest ❄️❄️.

When set at cold, the pan will stay at the normal refrigerator temperature.

The coldest setting provides the coldest storage area.



## About crisper removal.

www.GEAppliances.com

Not all features are on all models.

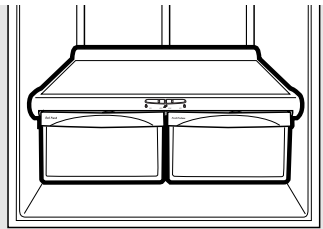

### Crisper Removal

#### To Remove:

These drawers can be removed easily by lifting up slightly while pulling the drawer past the **stop** location.

#### When the door cannot be fully opened,

remove the drawer farthest from the door first. Make sure the drawer closest to the door is fully closed. There is a latch at the front of the center slide rail. Push down on the latch and slide the center slide rail, to which the drawer is attached, away from the door. Remove the drawer.

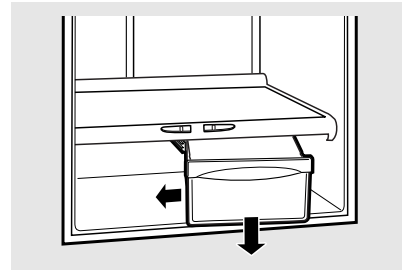
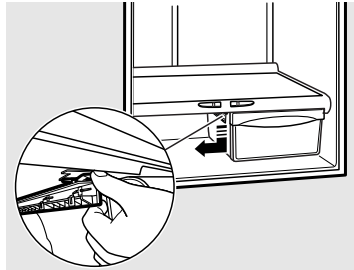

## About the automatic icemaker.

A newly-installed refrigerator may take 12–24 hours to begin making ice.

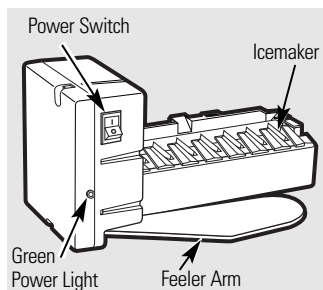

### Automatic Icemaker (on some models)

The icemaker will produce seven cubes per cycle—approximately 100–130 cubes in a 24-hour period, depending on freezer compartment temperature, room temperature, number of door openings and other use conditions.

If the refrigerator is operated before the water connection is made to the icemaker, set the power switch to **O (off)**.

When the refrigerator has been connected to the water supply, set the power switch to **I (on)**. The green light will come on.

The icemaker will fill with water when it cools to 15°F. A newly-installed refrigerator may take 12 to 24 hours to begin making ice cubes.

Throw away the first few batches of ice to allow the water line to clear.

Be sure nothing interferes with the sweep of the feeler arm.

When the bin fills to the level of the feeler arm, the icemaker will stop producing ice.

It is normal for several cubes to be joined together.

If ice is not used frequently, old ice cubes will become cloudy, taste stale and shrink.

If ice cubes get stuck in the icemaker, the green power light will blink. To correct this, set the power switch to **O (off)** and remove the cubes. Set the power switch to **I (on)** to restart the icemaker.

After the icemaker has been turned on again, there will be a delay of about 45 minutes before the icemaker resumes operations.

**NOTE:** In homes with lower-than-average water pressure, you may hear the icemaker cycle multiple times when making one batch of ice.

### Icemaker Accessory Kit

If your refrigerator did not come already equipped with an automatic icemaker, an icemaker accessory kit is available at extra cost.

Check the back of the refrigerator for the specific icemaker kit needed for your model.

## Care and cleaning of the refrigerator.

---

### Cleaning the Outside

**The door handles and trim.** Clean with a cloth dampened with soapy water. Dry with a soft cloth.

**Keep the outside clean.** Wipe with a clean cloth lightly dampened with mild liquid dish detergent. Dry with a clean, soft cloth.

*Do not wipe the refrigerator with a soiled dish cloth or wet towel. These may leave a residue that can erode the paint. Do not use scouring pads, powdered cleaners, bleach or cleaners containing bleach because these products can scratch and weaken the paint finish.*

### Cleaning the Inside

**To help prevent odors,** leave an open box of baking soda in the refrigerator and freezer compartments.

**Unplug the refrigerator before cleaning.** If this is not practical, wring excess moisture out of sponge or cloth when cleaning around switches, lights or controls.

Use warm water and baking soda solution—about a tablespoon (15 ml) of baking soda to a quart (1 liter) of water. This both cleans and neutralizes odors. Thoroughly rinse and wipe dry.

*Avoid cleaning cold glass shelves (on some models) with hot water because the extreme temperature difference may cause them to break. Handle glass shelves carefully. Bumping tempered glass can cause it to shatter.*

*Do not wash any refrigerator parts in the dishwasher.*

*Wash ice trays in lukewarm water only—do not put them in an automatic dishwasher.*

---

### **Behind the Refrigerator**

Be careful when moving the refrigerator away from the wall. All types of floor coverings can be damaged, particularly cushioned coverings and those with embossed surfaces.

*When pushing the refrigerator back, make sure you don't roll over the power cord or icemaker supply line (on some models).*

Pull the refrigerator straight out and return it to position by pushing it straight in. Moving the refrigerator in a side direction may result in damage to the floor covering or refrigerator.

---

### **Preparing for Vacation**

For long vacations or absences, remove food and unplug the refrigerator. Move the freezer control to the **O (off)** position, and clean the interior with a baking soda solution of one tablespoon (15 ml) of baking soda to one quart (1 liter) of water. Leave the doors open.

If the temperature can drop below freezing, have a qualified servicer drain the water supply system (on some models) to prevent serious property damage due to flooding.

Set the icemaker power switch to the **O (off)** position and shut off the water supply to the refrigerator.

---

### **Preparing to Move**

Secure all loose items such as base grille, shelves and drawers by taping them securely in place to prevent damage.

*Be sure the refrigerator stays in an upright position during moving.*

## Replacing the lightbulbs.

Turning the control to the **0 (off)** position does not remove power to the light circuit.

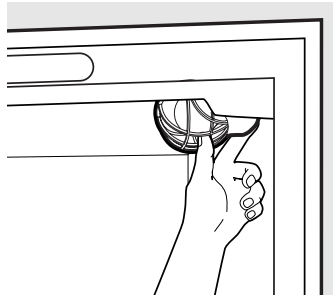

### Refrigerator Compartment

**CAUTION:** Lightbulbs may be hot.

- 1 Unplug the refrigerator.
- 2 The bulbs are located at the top of the refrigerator compartment near the opening. On some models, a light shield will have to be removed.
- 3 To remove the light shield, grasp the shield as shown. Squeeze the shield and rotate the shield towards the back of the refrigerator. The light shield will pop out.
- 4 Replace the bulb with an appliance bulb of the same or lower wattage. On models with a light shield, replace the light shield.
- 5 Plug the refrigerator back in.

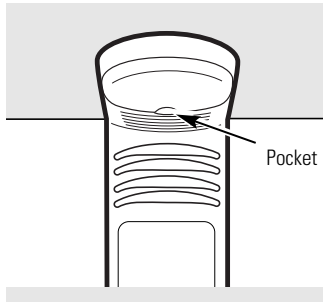

### Freezer Compartment Dome Light (on some models)

**CAUTION:** Lightbulbs may be hot.

- 1 Unplug the refrigerator.
- 2 The bulb is located at the top of the freezer compartment inside the dome light shield. To remove the shield, place your finger in the pocket at the back of the shield. Pull the shield forward and down.
- 3 After replacing with an appliance bulb of the same or lower wattage, replace the shield.
- 4 Plug the refrigerator back in.

# Installation Instructions

# Refrigerator

Models 22 and 25

If you have questions, call 1-800-GEARES or visit our Website at: [www.GEAppliances.com](http://www.GEAppliances.com)

## BEFORE YOU BEGIN

Read these instructions completely and carefully.

- **IMPORTANT** – Save these instructions for local inspector's use.
- **IMPORTANT** – Observe all governing codes and ordinances.
- **Note to Installer** – Be sure to leave these instructions with the Consumer.
- **Note to Consumer** – Keep these instructions for future reference.
- **Skill level** – Installation of this appliance requires basic mechanical skills.
- **Completion time** – Refrigerator Installation  
15 minutes
- Proper installation is the responsibility of the installer.
- Product failure due to improper installation is not covered under the Warranty.

## WATER SUPPLY TO THE ICEMAKER (ON SOME MODELS)

If the refrigerator has an icemaker, it will have to be connected to a cold water line. A GE water supply kit (containing tubing, shutoff valve, fittings and instructions) is available at extra cost from your dealer, by visiting our Website at [www.GEAppliances.com](http://www.GEAppliances.com) or from Parts and Accessories, 800-626-2002.

## REFRIGERATOR LOCATION

- Do not install the refrigerator where the temperature will go below 60°F (16°C) because it will not run often enough to maintain proper temperatures.
- Do not install the refrigerator where the temperature will go above 100°F (37°C) because it will not perform properly.
- Install it on a floor strong enough to support it fully loaded.

## CLEARANCES

Allow the following clearances for ease of installation, proper air circulation and plumbing and electrical connections.

- Sides 1/8" (4 mm)
- Top 1" (25 mm)
- Back 1" (25 mm)

If the refrigerator is against a wall on either side, allow a 1/8" (3 mm) door clearance.

## ROLLERS

The rollers have 3 purposes:

- Rollers adjust so the doors close on their own when opened about 45°.
- Rollers adjust so the refrigerator is firmly positioned on the floor and does not wobble.
- Rollers allow you to move the refrigerator away from the wall for cleaning.

To adjust the rollers:

- 1 Remove the base grille by positioning hands as shown.
- 2 Rotate the bottom of the grille outward until the clips snap out.
- 3 Pull the grille away from the refrigerator.
- 4 Using a screwdriver, turn the two front roller adjusting screws **clockwise to raise** the refrigerator, **counterclockwise to lower it**.
- 5 Replace the grille so the notch in the grille will fit around the bottom door hinge.
- 6 Tilt the top of the grille toward the refrigerator and insert the long metal clips into the top of the oval openings at the bottom of the refrigerator.
- 7 Rotate the bottom of the grille toward the refrigerator until it snaps into place.

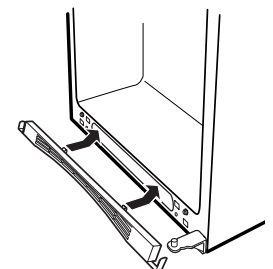
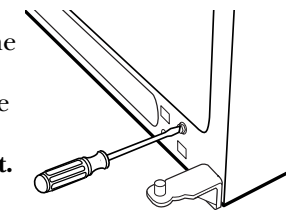
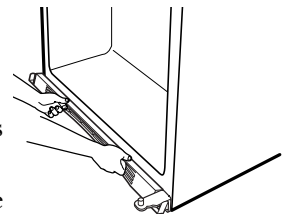

# Installation Instructions

## INSTALLING THE WATER LINE (ON SOME MODELS)

### BEFORE YOU BEGIN

Recommended copper water supply kits are WX8X2, WX8X3 or WX8X4, depending on the amount of tubing you need. Approved plastic water supply lines are GE SmartConnect™ Refrigerator Tubing (WX08X10002, WX08X10006, WX08X10015 and WX08X10025).

When connecting your refrigerator to a GE Reverse Osmosis Water System, the only approved installation is with a GE RVKit. For other reverse osmosis water systems, follow the manufacturer's recommendations.

This water line installation is not warranted by the refrigerator or icemaker manufacturer. Follow these instructions carefully to minimize the risk of expensive water damage.

Water hammer (water banging in the pipes) in house plumbing can cause damage to refrigerator parts and lead to water leakage or flooding. Call a qualified plumber to correct water hammer before installing the water supply line to the refrigerator.

To prevent burns and product damage, do not hook up the water line to the hot water line.

If you use your refrigerator before connecting the water line, make sure the icemaker power switch is in the **O (off)** position.

Do not install the icemaker tubing in areas where temperatures fall below freezing.

When using any electrical device (such as a power drill) during installation, be sure the device is double insulated or grounded in a manner to prevent the hazard of electric shock, or is battery powered.

All installations must be in accordance with local plumbing code requirements.

### WHAT YOU WILL NEED

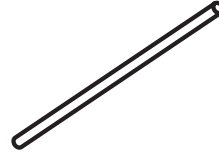

- **Copper or GE SmartConnect™ Refrigerator Tubing kit**, 1/4" outer diameter to connect the refrigerator to the water supply. If using copper, be sure both ends of the tubing are cut square.

To determine how much tubing you need: measure the distance from the water valve on the back of the refrigerator to the water supply pipe. Then add 8' (2.4 m). Be sure there is sufficient extra tubing (about 8' [2.4 m] coiled into 3 turns of about 10" [25 cm] diameter) to allow the refrigerator to move out from the wall after installation.

GE SmartConnect™ Refrigerator Tubing Kits are available in the following lengths:

2' (.6 m)	– WX08X10002
6' (1.8 m)	– WX08X10006
15' (4.6 m)	– WX08X10015
25' (7.6 m)	– WX08X10025

Be sure that the kit you select allows at least 8' (2.4 m) as described above.

**NOTE: The only GE approved plastic tubing is that supplied in GE SmartConnect™ Refrigerator Tubing kits. Do not use any other plastic water supply line because the line is under pressure at all times. Certain types of plastic will crack or rupture with age and cause water damage to your home.**

# Installation Instructions

## WHAT YOU WILL NEED (CONT.)

- A **GE water supply kit** (containing tubing, shutoff valve and fittings listed below) is available at extra cost from your dealer or from Parts and Accessories, 800-626-2002.
- A **cold water supply**. The water pressure must be between 20 and 120 p.s.i. (1.4–8.1 bar).

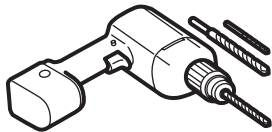

- **Power drill.**
- **1/2" or adjustable wrench.**
- **Straight and Phillips blade screwdriver.**

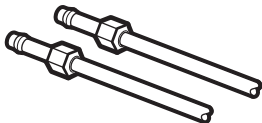

- **Two 1/4" outer diameter compression nuts and 2 ferrules (sleeves)**—to connect the copper tubing to the shutoff valve and the refrigerator water valve.

### OR

- If you are using a GE SmartConnect™ Refrigerator Tubing kit, the necessary fittings are preassembled to the tubing.

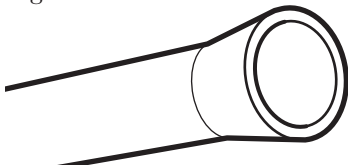

- If your existing copper water line has a flared fitting at the end, you will need an **adapter** (available at plumbing supply stores) to connect the water line to the refrigerator **OR** you can cut off the flared fitting with a **tube cutter** and then use a compression fitting. Do not cut formed end from GE SmartConnect™ Refrigerator tubing.

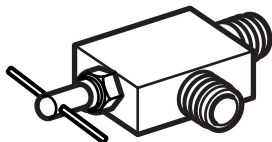

- **Shutoff valve** to connect to the cold water line. The shutoff valve should have a water inlet with a minimum inside diameter of 5/32" at the point of connection to the **COLD WATER LINE**. Saddle-type shutoff valves are included in many water supply kits. Before purchasing, make sure a saddle-type valve complies with your local plumbing codes.

Install the shutoff valve on the nearest frequently used drinking water line.

## 1 SHUT OFF THE MAIN WATER SUPPLY

Turn on the nearest faucet long enough to clear the line of water.

## 2 CHOOSE THE VALVE LOCATION

Choose a location for the valve that is easily accessible. It is best to connect into the side of a vertical water pipe. When it is necessary to connect into a horizontal water pipe, make the connection to the top or side, rather than at the bottom, to avoid drawing off any sediment from the water pipe.

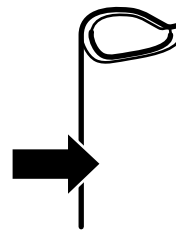

## 3 DRILL THE HOLE FOR THE VALVE

Drill a 1/4" hole in the water pipe (even if using a self-piercing valve) using a sharp bit. Remove any burrs resulting from drilling the hole in the pipe. **Take care not to allow water to drain into the drill.** Failure to drill a 1/4" hole may result in reduced ice production or smaller cubes.

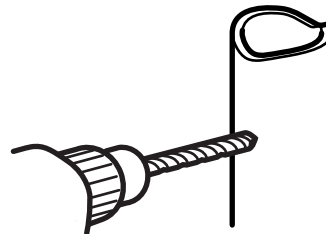

# Installation Instructions

## INSTALLING THE WATER LINE (CONT.)

### 4 FASTEN THE SHUTOFF VALVE

Fasten the shutoff valve to the cold water pipe with the pipe clamp.

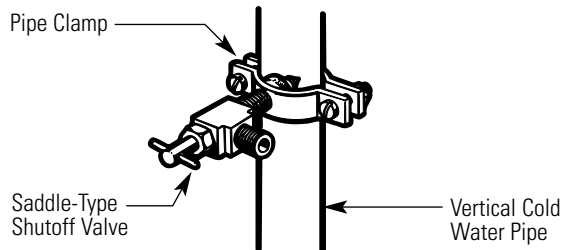

**NOTE:** Commonwealth of Massachusetts Plumbing Codes 248CMR shall be adhered to. Saddle valves are illegal and use is not permitted in Massachusetts. Consult with your licensed plumber.

### 5 TIGHTEN THE PIPE CLAMP

Tighten the clamp screws until the sealing washer begins to swell.

**NOTE:** Do not overtighten or you may crush the tubing.

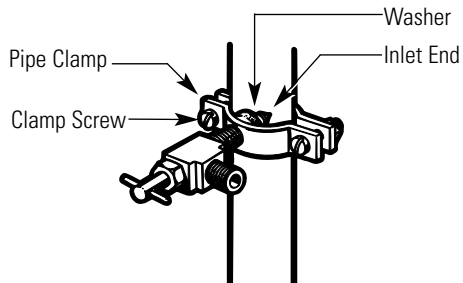

### 6 ROUTE THE TUBING

Route the tubing between the cold water line and the refrigerator.

Route the tubing through a hole drilled in the wall or floor (behind the refrigerator or adjacent base cabinet) as close to the wall as possible.

**NOTE:** Be sure there is sufficient extra tubing [about 8 feet (244 cm) coiled into 3 turns of about 10" (25 cm) diameter] to allow the refrigerator to move out from the wall after installation.

### 7 CONNECT THE TUBING TO THE VALVE

Place the compression nut and ferrule (sleeve) for copper tubing onto the end of the tubing and connect it to the shutoff valve.

Make sure the tubing is fully inserted into the valve. Tighten the compression nut securely.

For plastic tubing from a GE SmartConnect™ Refrigerator Tubing kit, insert the molded end of the tubing into the shutoff valve and tighten compression nut until it is hand tight, then tighten one additional turn with a wrench. Overtightening may cause leaks.

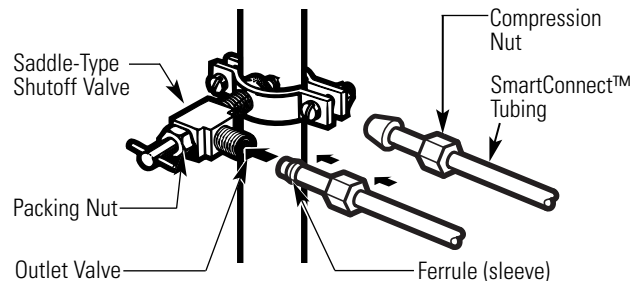

**NOTE:** Commonwealth of Massachusetts Plumbing Codes 248CMR shall be adhered to. Saddle valves are illegal and use is not permitted in Massachusetts. Consult with your licensed plumber.

### 8 FLUSH OUT THE TUBING

Turn the main water supply on and flush out the tubing until the water is clear.

Shut the water off at the water valve after about one quart (1 liter) of water has been flushed through the tubing.

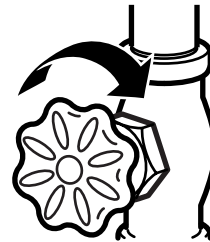



# Installation Instructions

## 9 CONNECT THE TUBING TO THE REFRIGERATOR

### NOTES:

- Before making the connection to the refrigerator, be sure the refrigerator power cord is not plugged into the wall outlet.
- We recommend installing a water filter if your water supply has sand or particles that could clog the screen of the refrigerator's water valve. Install it in the water line near the refrigerator. If using GE SmartConnect Refrigerator Tubing kit, you will need an additional tube (WX08X10002) to connect the filter. Do not cut plastic tube to install filter.

Remove the access cover.

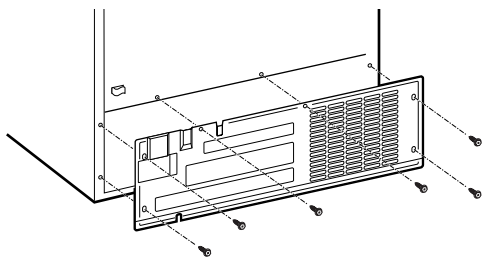

Remove the plastic flexible cap from the water valve (refrigerator connection).

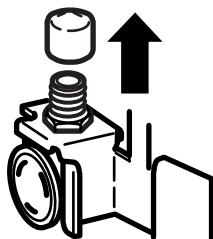

Place the compression nut and ferrule (sleeve) onto the end of the tubing as shown. On GE SmartConnect™ Refrigerator Tubing kit, the nuts are already assembled to the tubing.

## 9 CONNECT THE TUBING TO THE REFRIGERATOR (CONT.)

Insert the end of the tubing into the water valve connection as far as possible. While holding the tubing, tighten the fitting.

For plastic tubing from a GE SmartConnect™ Refrigerator Tubing kit, insert the molded end of the tubing into the shutoff valve and tighten compression nut until it is hand tight, then tighten one additional turn with a wrench. Overtightening may cause leaks.

Fasten the tubing into the clamp provided to hold it in a vertical position. You may need to pry open the clamp.

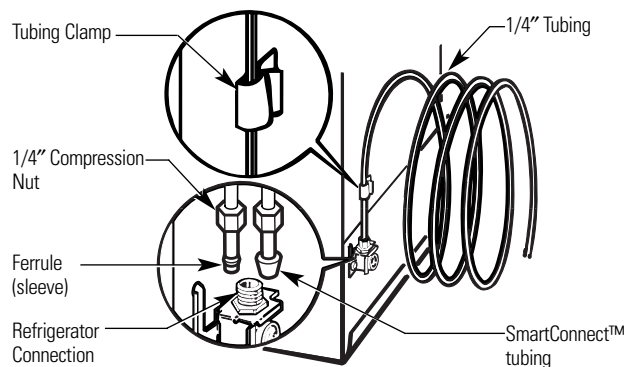

## 10 TURN THE WATER ON AT THE SHUTOFF VALVE

Tighten any connections that leak.

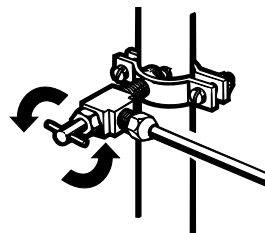

Reattach the access cover.

# Installation Instructions

## INSTALLING THE WATER LINE (CONT.)

### 11 PLUG IN THE REFRIGERATOR

Arrange the coil of tubing so that it does not vibrate against the back of the refrigerator or against the wall. Push the refrigerator back to the wall.

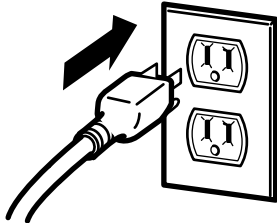

### START THE ICEMAKER

Set the icemaker power switch to the **I (on)** position. The icemaker will not begin to operate until it reaches its operating temperature of 15°F (-9°C) or below. It will then begin operation automatically if the icemaker power switch is in the **I (on)** position.

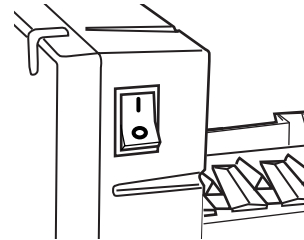

**NOTE:** In lower water pressure conditions, the water valve may turn on up to 3 times to deliver enough water to the icemaker

## REVERSING THE DOOR SWING

### IMPORTANT NOTES

When reversing the door swing:

- Read the instructions all the way through before starting.
- Handle parts carefully to avoid scratching paint.
- Set screws down by their related parts to avoid using them in the wrong places.
- Provide a non-scratching work surface for the doors.

**IMPORTANT:** Once you begin, do not move the cabinet until door-swing reversal is completed.

These instructions are for changing the hinges from the right side to the left side—if you ever want to change the hinges back to the right side, follow these same instructions and reverse all references to left and right.

**Unplug the refrigerator from its electrical outlet.**

**Empty all door shelves, including the dairy compartment.**

### TOOLS YOU WILL NEED



Phillips screwdriver



3/4" Hex socket driver  
(a 6-point socket is recommended)



Masking tape

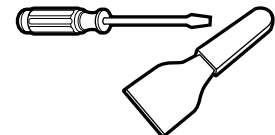

Putty knife or  
thin-blade screwdriver



T20 or T25 Torxdriver,  
whichever your model  
requires

# Installation Instructions

## 1 REMOVE THE FREEZER DOOR

Tape the door shut with masking tape.

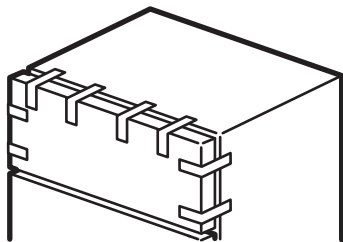

Remove the hinge cover on top of the freezer door (on some models).

Remove the two Torx screws, then lift the hinge straight up to free the hinge pin from the socket in the top of the door.

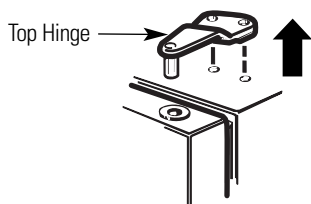

Tape the door shut with masking tape.

Remove the tape and tilt the door away from the cabinet. Lift it off the center hinge pin.

Set the door on a non-scratching surface with the inside up.

## 2 REMOVE THE REFRIGERATOR DOOR

Tape the door shut with masking tape.

Remove the center hinge pin with a 3/4" socket.

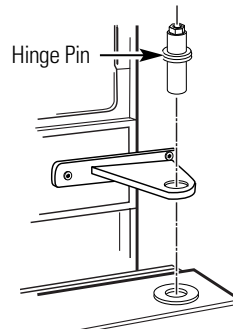

Remove the tape and tilt the door away from the cabinet. Lift the door straight off the bottom hinge bracket.

Set the door on a non-scratching surface, with the inside up.

**CAUTION:** Do not let door drop to the floor. To do so could damage the door stop.

## 3 TRANSFER TOP HINGE TO THE LEFT

Interchange hinge and screws at top right with screws at the top left of cabinet.

**Do not tighten screws on hinge side at this time.**

# Installation Instructions

## REVERSING THE DOOR SWING (CONT.)

### 4 TRANSFER BOTTOM HINGE BRACKET TO THE LEFT

Remove the base grille by pulling it straight out.

Using a Torx Driver, move the bottom hinge bracket from the right side to the left side.

**NOTE:** If the washer is not on the hinge bracket, check to see if it is stuck to the bottom of the door.

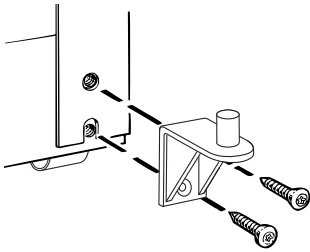

### 5 TRANSFER CENTER HINGE BRACKET TO THE LEFT

Remove the center hinge bracket by removing the three Torx screws

**NOTE:** Keep these screws with the hinge bracket. They are long screws and will be used when installing the hinge on the other side.

You will need to remove the color-matched cap from the screw head before you can remove the screw. Use the edge of a thin flat blade to gently pry the caps off the screw heads. (A putty knife works well for this.) Cover the blade with tape to prevent scratching the paint.

Remove the mullion cover from the left side using the thin flat blade. Assemble it to the right side.

Remove the Torx screw from the center left side of the cabinet. Screw it into the holes on the right side.

Place the center hinge bracket over the holes at the center left side of the cabinet. Insert and tighten the three long screws.

Replace the cap by snapping it over the screw with your finger.

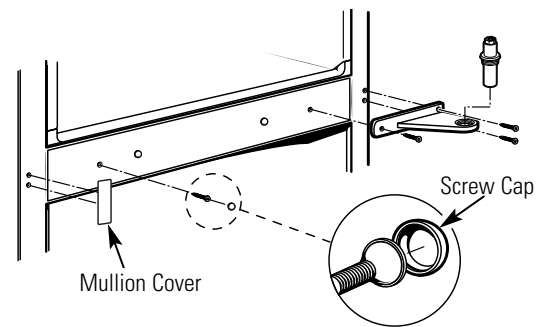

### 6 TRANSFER DOOR STOPS

On each door, move the metal door stop from the right to the left.

Move any screws from the left to the right.

# Installation Instructions

## 7 TRANSFER REFRIGERATOR DOOR HANDLE TO THE RIGHT

**To remove the handle:** Remove the plug button by carefully prying under the edge with a putty knife. Remove the exposed screw holding the handle.

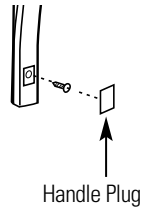

Remove the two screws holding the handle to the top of the door.

### Long Handle

### Short Handle

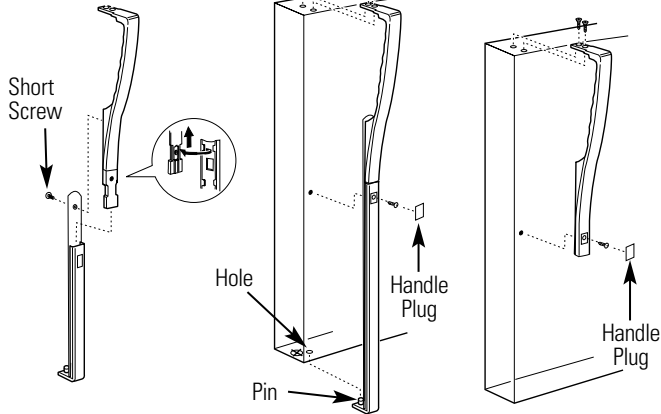

**After removing the handle:** Move the small plug buttons from the top right side of the door top and insert them into the holes on the opposite side.

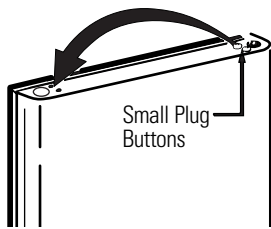

Move the large plug button from the left edge of the door and insert it into the hole on the opposite side.

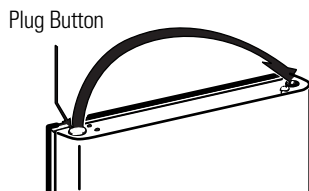

## 7 TRANSFER REFRIGERATOR DOOR HANDLE TO THE RIGHT (CONT.)

Transfer the door plug button to the opposite side.

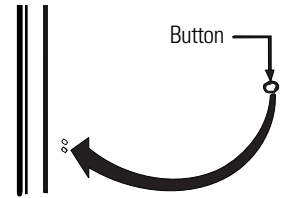

**Reinstalling the handle:** Attach the handle to the right side of the door.

### Long Handle

### Short Handle

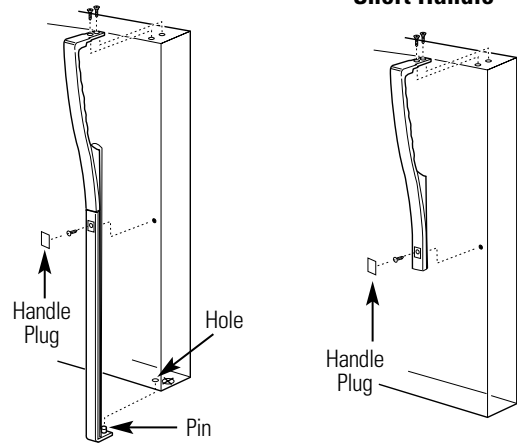

# Installation Instructions

## REVERSING THE DOOR SWING (CONT.)

### 8 TRANSFER FREEZER DOOR HANDLE TO THE RIGHT

Remove the screws holding the handle to the top and bottom of the door. Remove handle.

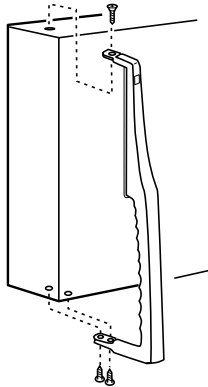

Move the plug button on the right side of the door to the handle screw hole on the left side.

Reattach the handle on the opposite side using the holes closest to the edge of the door.

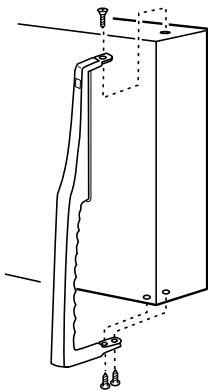

### 9 REHANG THE REFRIGERATOR DOOR

Lower the refrigerator door onto the bottom hinge pin.

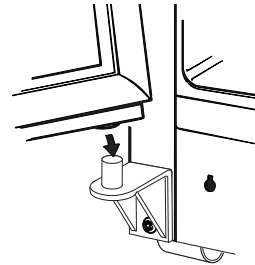

Straighten the door and line it up with the center hinge bracket.

Reinstall the center hinge pin with a 3/4" socket. Turn it until it extends through the hinge bracket and into the door.

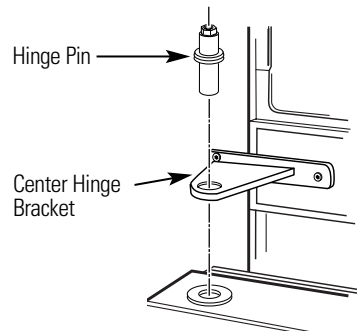

# Installation Instructions

---

## **10** REHANG THE FREEZER DOOR

Lower the freezer door onto the center hinge pin.

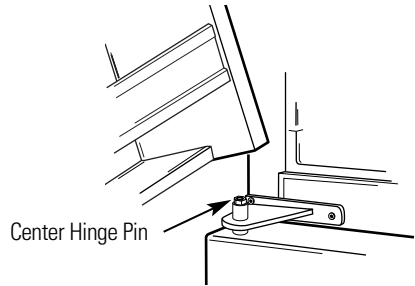

Lift the top hinge so the pin fits into the door socket.

Support the door on the handle side and make sure the door is straight and the gap between the doors is even across the front. While holding the door in place, tighten the top hinge screws.

## Normal operating sounds.

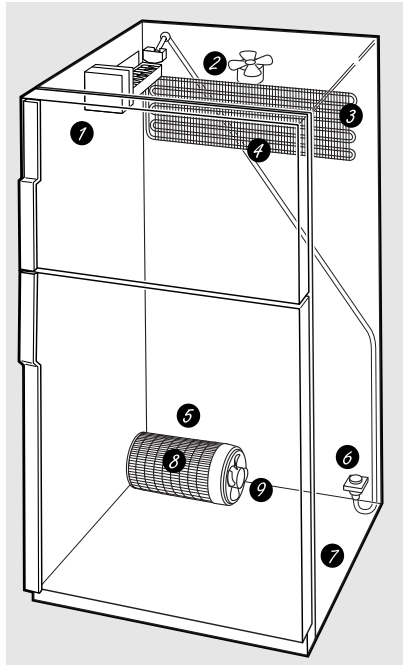

These sounds are normal and are due mostly to highly efficient operation.

- 1 Icemaker (on some models).** Occasionally you will hear ice cubes dropping into the ice bin. If this is your first icemaker, you'll hear occasional sounds that may be unfamiliar. They are normal icemaking sounds and are not a cause for concern.

The icemaker water valve will buzz when the icemaker fills with water. If the power switch is in the **I (on)** position it will buzz even if it has not yet been hooked up to water. Keeping the power switch in the **I (on)** position before it is hooked up to water can damage the icemaker. To prevent this, set the power switch to the **O (Off)** position. This will stop the buzzing.
- 2 Evaporator Fan.\*** You may hear air being forced through the cabinet by the fan. The fan operates at different speeds depending on cooling needs. If either door remains open for more than 3 minutes, the fan will come on.
- 3 Evaporator.** The flow of refrigerant through the evaporator may create a slight bubbling or gurgling sound.
- 4 Defrost Heater.** During defrost cycles, water dripping onto the heater may cause a hissing or sizzling sound. After defrosting, a popping sound may occur and the evaporator may create a slight bubbling or gurgling sound.
- 5 Plastic Liner.** Cracking or popping sounds due to expansion of the plastic liner. This occurs mainly when cooling down from room temperature.
- 6 Water Valve (on models equipped with an automatic icemaker).** When the icemaker fills with water, a buzzing sound and running water will be heard. If you have low water pressure, you may hear the icemaker cycle several times when making one batch of ice.
- 7 Water Pan.** Water may be heard running into the maintenance-free drain pan during the defrost cycle.
- 8 Compressor.\*** Modern, high efficiency compressors operate much faster than older models. The compressor may have a high pitched hum or pulsating sound.
- 9 Condenser Fan.\*** You may hear air being forced over the condenser by the fan.

\* When the control settings are changed, the compressor and fans may not react immediately.





**Troubleshooting Tips**  
 Save time and money! Review the charts on the following pages first and you may not need to call for service.

<b>Problem</b>	<b>Possible Causes</b>	<b>What To Do</b>
<b>Refrigerator does not operate</b>	Refrigerator in defrost cycle.	• Wait about 40 minutes for defrost cycle to end.
	Either or both controls set to <b>0 (off)</b> position.	• Move the refrigerator and freezer control to a temperature setting.
	Refrigerator is unplugged.	• Push the plug completely into the outlet.
	The fuse is blown/circuit breaker is tripped.	• Replace fuse or reset the breaker.
<b>Vibration or rattling (slight vibration is normal)</b>	Rollers need adjusting.	• See <i>Rollers</i> .
<b>Motor operates for long periods or cycles on and off frequently. (Modern refrigerators with more storage space and a larger freezer require more operating time. They start and stop often to maintain even temperatures.)</b>	Normal when refrigerator is first plugged in.	• Wait 24 hours for the refrigerator to completely cool down.
	Often occurs when large amounts of food are placed in refrigerator.	• This is normal.
	Door left open.	• Check to see if package is holding door open.
	Hot weather or frequent door openings.	• This is normal.
	Temperature controls set at the coldest setting.	• See <i>About the controls</i> .
<b>Refrigerator or freezer compartment too warm</b>	Temperature control not set cold enough.	• See <i>About the controls</i> .
	Warm weather or frequent door openings.	• Set the temperature control one step colder. See <i>About the controls</i> .
	Door left open.	• Check to see if package is holding door open.
<b>Frost or ice crystals on frozen food (frost within package is normal)</b>	Door left open.	• Check to see if package is holding door open.
	Too frequent or too long door openings.	
<b>Automatic icemaker (on some models) does not work</b>	Icemaker power switch is in the <b>0 (off)</b> position.	• Set the power switch to the <b>I (on)</b> position.
	Water supply turned off or not connected.	• See <i>Installing the water line</i> .
	Freezer compartment too warm.	• Wait 24 hours for the refrigerator to completely cool down.
	Piled up cubes in the storage bin cause the icemaker to shut off.	• Level cubes by hand.
	Ice cubes stuck in icemaker. (Green power light on icemaker blinking).	• Turn off the icemaker, remove cubes, and turn the icemaker back on.

## Before you call for service...



### Troubleshooting Tips

<b>Problem</b>	<b>Possible Causes</b>	<b>What To Do</b>
<b>Ice cubes have odor/taste</b>	Ice storage bin needs cleaning.	• Empty and wash bin. Discard old cubes.
	Food transmitting odor/taste to ice cubes.	• Wrap foods well.
	Interior of refrigerator needs cleaning.	• See <i>Care and cleaning</i> .
<b>Slow ice cube freezing</b>	Door left open.	• Check to see if package is holding door open.
	Temperature control not set cold enough.	• See <i>About the controls</i> .
<b>No ice cube production</b>	Supply line or shutoff valve is clogged.	• Call a plumber.
<b>Refrigerator has odor</b>	Foods transmitting odor to refrigerator.	• Foods with strong odors should be tightly wrapped. • Keep an open box of baking soda in the refrigerator; replace every three months.
	Interior needs cleaning.	• See <i>Care and cleaning</i> .
<b>Moisture collects inside (in humid weather, air carries moisture into refrigerator when doors are opened)</b>	Too frequent or too long door openings.	
<b>Interior light does not work</b>	No power at outlet.	• Replace fuse or reset the breaker.
	Lightbulb burned out.	• See <i>Replacing the lightbulbs</i> .
<b>Hot air from bottom of refrigerator</b>	Normal air flow cooling motor. In the refrigeration process, it is normal that heat be expelled in the area under the refrigerator. Some floor coverings are sensitive and will discolor at these normal and safe temperatures.	
<b>Food freezing in the refrigerator</b>	Food too close to air vent.	• Move the food away from the air vent (near the controls).
	Refrigerator control is set too cold.	• Move the refrigerator control to a warmer temperature.
<b>Door does not close by itself</b>	Rollers need adjusting.	• See <i>Rollers</i> .
<b>Orange glow in the freezer</b>	Defrost heater is on.	• This is normal.

## GE Service Protection Plus™

GE, a name recognized worldwide for quality and dependability, offers you Service Protection Plus™—comprehensive protection on all your appliances—**No Matter What Brand!**

**Benefits Include:**

- Backed by GE
- All brands covered
- Unlimited service calls
- All parts and labor costs included
- No out-of-pocket expenses
- No hidden deductibles
- One 800 number to call

***We'll Cover Any Appliance.  
Anywhere. Anytime.\****

You will be completely satisfied with our service protection or you may request your money back on the remaining value of your contract. No questions asked. It's that simple.

Protect your refrigerator, dishwasher, washer and dryer, range, TV, VCR and much more—**any brand!** Plus there's no extra charge for emergency service and low monthly financing is available. Even icemaker coverage and food spoilage protection is offered. You can rest easy, knowing that all your valuable household products are protected against expensive repairs.

Place your confidence in GE and call us in the U.S. toll-free at **800-626-2224** for more information.

\*All brands covered, up to 20 years old, in the continental U.S.



Please place in envelope and mail to:

***General Electric Company***  
**Warranty Registration Department**  
**P.O. Box 32150**  
**Louisville, KY 40232-2150**

# Consumer Product Ownership Registration

Dear Customer:

Thank you for purchasing our product and thank you for placing your confidence in us.

We are proud to have you as a customer!

Follow these three steps to protect your new appliance investment:

# 1

**Complete and mail your Consumer Product Ownership Registration today.** Have the peace of mind of knowing we can contact you in the unlikely event of a safety modification.

# 2

After mailing the registration below, store this document in a safe place. It contains information you will need should you require service. Our service number is 800 GE CARES (800-432-2737).

# 3

Read your Owner's Manual carefully. It will help you operate your new appliance properly.

Model Number

Serial Number

**Important: If you did not get a registration card with your product, detach and return the form below to ensure that your product is registered, or register online at [www.GEAppliances.com](http://www.GEAppliances.com).**

 Cut here

## Consumer Product Ownership Registration



Model Number

Serial Number

Mr.  Ms.  Mrs.  Miss

First Name

Last Name

Street Address

Apt. #

E-mail Address\*

City

State

Zip Code

Date Placed In Use  
Month

Day

Year

Phone Number

\* Please provide your e-mail address to receive, via e-mail, discounts, special offers and other important communications from GE Appliances (GEA).

Check here if you do not want to receive communications from GEA's carefully selected partners.



**GE Appliances**

General Electric Company  
Louisville, Kentucky  
[www.GEAppliances.com](http://www.GEAppliances.com)

# CONSUMER WARRANTY

(for customers in Canada)

Your refrigerator is warranted to be free of defects in material and workmanship.

What is covered	How Long Warranted (From Date of Sale)	Parts Repair or Replace at Camco's Option	Labour
Compressor	Five (5) Years	Five (5) Years	Five (5) Years
Sealed System (including evaporator, condenser tubing and refrigerant)	Five (5) Years	Five (5) Years	Five (5) Years
All Other Parts	One (1) Year	One (1) Year	One (1) Year

## TERMS AND CONDITIONS:

This warranty applies only for single family domestic use in Canada when the Refrigerator has been properly installed according to the instructions supplied by Camco and is connected to an adequate and proper utility service.

Damage due to abuse, accident, commercial use, and alteration or defacing of the serial plate cancels all obligations of this warranty.

Service during this warranty must be performed by an Authorized Camco Service Agent.

Neither Camco nor the Dealer is liable for any claims or damages resulting from any failure of the Refrigerator or from service delays beyond their reasonable control.

To obtain warranty service, purchaser must present the original bill of sale. Components repaired or replaced are warranted through the remainder of the original warranty period only.

This warranty is in addition to any statutory warranty.

## IMPORTANT

**Keep this warranty and your bill of sale as proof of original purchase and purchase date.**

Camco Service is available coast to coast. If further help is needed concerning this warranty, contact:

Manager, Consumer Relations  
Camco Inc.  
Suite 310  
1 Factory Lane  
Moncton, N.B.  
E1C 9M3

## WHAT IS NOT COVERED:

- Service trips to your home to teach you how to use the product.
- Damage to finish after delivery.
- Improper installation—proper installation includes adequate air circulation to the refrigeration system, adequate electrical, plumbing and other connecting facilities.
- Replacement of house fuses or resetting of circuit breakers.
- Replacement of lightbulbs.
- Damage to product caused by accident, fire, floods or acts of God.
- Loss of food due to spoilage.
- Proper use and care of product as listed in the owner's manual, proper setting of controls.
- **WARRANTOR IS NOT RESPONSIBLE FOR CONSEQUENTIAL DAMAGES.**

*Staple your receipt here.  
Proof of the original purchase  
date is needed to obtain service  
under the warranty.*

## Refrigerator Warranty. *(For customers in the United States)*



All warranty service provided by our Factory Service Centers, or an authorized Customer Care® technician. To schedule service, on-line, 24 hours a day, contact us at [www.GEApliances.com](http://www.GEApliances.com), or call 800-GE-CARES.

Staple your receipt here.  
Proof of the original purchase date is needed to obtain service under the warranty.

For The Period Of:	GE Will Replace:
<b>One Year</b> From the date of the original purchase	<b>Any part</b> of the refrigerator (excluding water filter cartridge) which fails due to a defect in materials or workmanship. During this <b>full one-year warranty</b> , GE will also provide, <b>free of charge</b> , all labor and in-home service to replace the defective part.
<b>Five Years</b> From the date of the original purchase	<b>Any part of the sealed refrigerating system</b> (the compressor, condenser, evaporator and all connecting tubing) which fails due to a defect in materials or workmanship. During this <b>full five-year sealed refrigerating system warranty</b> , GE will also provide, <b>free of charge</b> , all labor and in-home service to replace the defective part in the sealed refrigerating system.

### What GE Will Not Cover:

- Service trips to your home to teach you how to use the product.
- Replacement of house fuses or resetting of circuit breakers.
- Improper installation.
- Damage to the product caused by accident, fire, floods or acts of God.
- Failure of the product if it is abused, misused, or used for other than the intended purpose or used commercially.
- Incidental or consequential damage caused by possible defects with this appliance.
- Loss of food due to spoilage.

*This warranty is extended to the original purchaser and any succeeding owner for products purchased for home use within the USA. In Alaska, the warranty excludes the cost of shipping or service calls to your home.*

*Some states do not allow the exclusion or limitation of incidental or consequential damages. This warranty gives you specific legal rights, and you may also have other rights which vary from state to state. To know what your legal rights are, consult your local or state consumer affairs office or your state's Attorney General.*

**Warrantor: General Electric Company, Louisville, KY 40225**

***Safety Instructions***

***Operating Instructions***

***Installation Instructions***

***Troubleshooting Tips***

***Customer Service***

## Consumer Support.

---



### *GE Appliances Website*

[www.GEAppliances.com](http://www.GEAppliances.com)

Have a question or need assistance with your appliance? Try the GE Appliances Website 24 hours a day, any day of the year! For greater convenience and faster service, you can now download Owner's Manuals, order parts, catalogs, or even schedule service on-line. You can also "Ask Our Team of Experts™" your questions, and so much more...



### *Schedule Service*

[www.GEAppliances.com](http://www.GEAppliances.com)

Expert GE repair service is only one step away from your door. Get on-line and schedule your service at your convenience 24 hours any day of the year! Or call 800-GE-CARES (800-432-2737) during normal business hours.



### *Real Life Design Studio*

[www.GEAppliances.com](http://www.GEAppliances.com)

GE supports the Universal Design concept—products, services and environments that can be used by people of all ages, sizes and capabilities. We recognize the need to design for a wide range of physical and mental abilities and impairments. For details of GE's Universal Design applications, including kitchen design ideas for people with disabilities, check out our Website today. For the hearing impaired, please call 800-TDD-GEAC (800-833-4322).



### *Extended Warranties*

[www.GEAppliances.com](http://www.GEAppliances.com)

Purchase a GE extended warranty and learn about special discounts that are available while your warranty is still in effect. You can purchase it on-line anytime, or call 800-626-2224 during normal business hours. GE Consumer Home Services will still be there after your warranty expires.

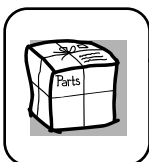

### *Parts and Accessories*

[www.GEAppliances.com](http://www.GEAppliances.com)

Individuals qualified to service their own appliances can have parts or accessories sent directly to their homes (VISA, MasterCard and Discover cards are accepted). Order on-line today, 24 hours every day or by phone at 800-626-2002 during normal business hours.

**Instructions contained in this manual cover procedures to be performed by any user. Other servicing generally should be referred to qualified service personnel. Caution must be exercised, since improper servicing may cause unsafe operation.**



### *Contact Us*

[www.GEAppliances.com](http://www.GEAppliances.com)

If you are not satisfied with the service you receive from GE, contact us on our Website with all the details including your phone number, or write to: General Manager, Customer Relations  
GE Appliances, Appliance Park  
Louisville, KY 40225



### *Register Your Appliance*

[www.GEAppliances.com](http://www.GEAppliances.com)

**Register your new appliance on-line—at your convenience!** Timely product registration will allow for enhanced communication and prompt service under the terms of your warranty, should the need arise. You may also mail in the pre-printed registration card included in the packing material, or detach and use the form in this Owner's Manual.